

THAI CREAMED HONEY DEVELOPMENT BY CONTROL OF  
CRYSTALLIZATION PROCESS WITH ULTRASONIC TREATMENT



DOCTOR OF ENGINEERING IN FOOD ENGINEERING  
MAEJO UNIVERSITY  
2021

THAI CREAMED HONEY DEVELOPMENT BY CONTROL OF  
CRYSTALLIZATION PROCESS WITH ULTRASONIC TREATMENT



VORALUCK SURIWONG

A DISSERTATION SUBMITTED IN PARTIAL FULFILLMENT  
OF THE REQUIREMENTS FOR THE DEGREE OF DOCTOR OF ENGINEERING  
IN FOOD ENGINEERING

ACADEMIC ADMINISTRATION AND DEVELOPMENT MAEJO UNIVERSITY

2021

Copyright of Maejo University

THAI CREAMED HONEY DEVELOPMENT BY CONTROL OF  
CRYSTALLIZATION PROCESS WITH ULTRASONIC TREATMENT

VORALUCK SURIWONG

THIS DISSERTATION HAS BEEN APPROVED IN PARTIAL FULFLLMENT  
OF THE REQUIREMENTS FOR THE DEGREE OF DOCTOR OF ENGINEERING  
IN FOOD ENGINEERING

APPROVED BY

Advisory Committee

Chair .....

(Associate Professor Dr. Somkiat  
Jaturonglumlert)

...../...../.....

Committee .....

(Associate Professor Dr. Jaturapatr Varith)

...../...../.....

Committee .....

(Assistant Professor Dr. Kanjana Narkprasom)

...../...../.....

Program Chair, Doctor of Engineering .....

in Food Engineering(Assistant Professor Dr. Chanawat Nitatwichit)

...../...../.....

CERTIFIED BY ACADEMIC

.....

ADMINISTRATION AND DEVELOPMENT

(Associate Professor Dr. Yanin Opatpatanakit)

Vice President for the Acting President of Maejo  
University

...../...../.....

ชื่อเรื่อง	การพัฒนาครีมน้ำผึ้งไทยด้วยกระบวนการตกผลึกแบบควบคุมด้วยคลื่นอัลตราโซนิก
ชื่อผู้เขียน	นางวรลักษณ์ สุริวงษ์
ชื่อปริญญา	วิศวกรรมศาสตรดุษฎีบัณฑิต สาขาวิชาวิศวกรรมอาหาร
อาจารย์ที่ปรึกษาหลัก	รองศาสตราจารย์ ดร.สมเกียรติ จตุรงค์กล้าเลิศ

### บทคัดย่อ

น้ำผึ้งไทยเป็นสารให้ความหวานทางธรรมชาติที่อุดมไปด้วยน้ำตาลหลายชนิดโดยมีน้ำตาลกลูโคสและฟรุกโทสเป็นองค์ประกอบหลัก น้ำผึ้งโดยทั่วไปจะเกิดการตกผลึกจากปริมาณน้ำตาลกลูโคสที่มีอยู่มากในน้ำผึ้งและจัดเป็นลักษณะที่ไม่พึงประสงค์ต่อผู้บริโภค การตกผลึกโดยธรรมชาติจะทำให้เกิดลักษณะผลึกและเนื้อสัมผัสที่ไม่เหมาะสม การควบคุมกระบวนการตกผลึกเพื่อพัฒนาเป็นผลิตภัณฑ์ครีมน้ำผึ้งจึงเป็นอีกทางเลือกหนึ่งเพื่อเป็นการเพิ่มมูลค่าผลิตภัณฑ์น้ำผึ้งและจัดเป็นผลิตภัณฑ์ที่น่าสนใจต่อการพัฒนาต่อยอดเพื่อเพิ่มทางเลือกให้กับอุตสาหกรรมน้ำผึ้งไทยเป็นอย่างมาก อย่างไรก็ตามกระบวนการผลิตครีมน้ำผึ้งให้ได้เนื้อสัมผัสที่ดีเป็นไปได้ยาก โดยเฉพาะในการควบคุมกระบวนการตกผลึก คลื่นอัลตราโซนิกจัดเป็นเครื่องมือที่มีประสิทธิภาพในการช่วยเตรียมสภาพน้ำผึ้งให้พร้อมต่อการสร้างผลึกขนาดเล็กจำนวนมากเพื่อเหมาะต่อการตกผลึกที่อุดมไปด้วยผลึกที่มีขนาดสม่ำเสมอ ดังนั้น งานวิจัยนี้จึงมุ่งพัฒนากระบวนการผลิตครีมน้ำผึ้งแบบควบคุมด้วยคลื่นอัลตราโซนิกเพื่อให้ได้ผลิตภัณฑ์ครีมน้ำผึ้งที่มีเนื้อสัมผัสที่ดีและละเอียด รวมถึงได้ศึกษาถึงปัจจัยที่มีผลต่อการตกผลึก สภาพการเก็บรักษาที่เหมาะสมและลักษณะการคงตัวของครีมที่เปลี่ยนแปลงไปในระหว่างการเก็บรักษา การศึกษาแบบจำลองทางคณิตศาสตร์ของการตกผลึกน้ำผึ้งเพื่อนำไปใช้ในการออกแบบเครื่องต้นแบบในการผลิตครีมน้ำผึ้ง

อัตราส่วนของกลูโคสต่อน้ำเป็นตัวแปรสำคัญในการควบคุมการตกผลึกน้ำผึ้ง พบว่าน้ำผึ้งดอกทานตะวันจะมีอัตราส่วนกลูโคสต่อน้ำสูงกว่า 2.16 ในขณะที่น้ำผึ้งดอกกล้วยและน้ำผึ้งดอกไม้ป่ามีอัตราส่วนของกลูโคสต่อน้ำต่ำกว่า 1.70 น้ำผึ้งดอกทานตะวันจึงจัดเป็นน้ำผึ้งชนิดที่มีโอกาสเกิดการตกผลึกได้เร็ว ในขณะที่น้ำผึ้งดอกกล้วยและน้ำผึ้งดอกไม้ป่าจัดเป็นน้ำผึ้งที่มีโอกาสเกิดการตกผลึกได้ยากหรือไม่เกิดการตกผลึกแม้เก็บไว้ในที่อุณหภูมิต่ำก็ตาม เพื่อปรับสภาพน้ำผึ้งที่ตกผลึกยากให้เหมาะต่อการนำไปผลิตครีมน้ำผึ้งได้ พบว่า การเพิ่มกลูโคสในน้ำผึ้งในปริมาณ 2.0%w/w จะช่วยเพิ่มอัตราส่วนกลูโคสต่อน้ำในน้ำผึ้งที่ตกผลึกยากและไม่ส่งผลต่อคุณภาพทางชีวเคมีของน้ำผึ้ง

รวมถึงช่วยให้น้ำผึ้งมีคุณสมบัติเหมาะต่อการนำไปผลิตครีมน้ำผึ้งได้

กระบวนการผลิตครีมน้ำผึ้งด้วยการควบคุมการตกผลึกด้วยคลื่นอัลตราโซนิคที่พัฒนาได้ เริ่มจากการให้ความร้อนด้วยคลื่นอัลตราโซนิคที่ความถี่ 40 กิโลเฮิร์ตซ์ ที่อุณหภูมิ 55 องศาเซลเซียส 30 นาที เพื่อพาสเจอร์ไรส์และเตรียมสภาพน้ำผึ้งเหลวให้เหมาะต่อการตกผลึกที่ดี จากนั้นทำให้เย็นลงอย่างรวดเร็วในอัตรา 6.5 องศาเซลเซียสต่อนาที เพื่อทำให้น้ำผึ้งอุณหภูมิต่ำกว่า 20 องศาเซลเซียส ในเวลาอันสั้น เดิมตัวล่อผลึกที่เหมาะสมสำหรับการเติมขึ้นอยู่กับอัตราส่วนกลูโคสต่อ น้ำของน้ำผึ้งนั้น โดยจะมีช่วงระหว่าง 7.50 – 15.0%w/w กวนผสมระดับสูงด้วยความเร็วรอบไม่เกิน 1,300 รอบต่อนาทีเพื่อให้ตัวล่อผลึกผสมเป็นเนื้อเดียวกับน้ำผึ้งเหลวและป้องกันการเกิดฟองอากาศ ในเนื้อครีม ทรีทด้วยอัลตราโซนิคที่ความถี่ 40 กิโลเฮิร์ตซ์ กำลัง 0.15 วัตต์ต่อตารางเซนติเมตร ในน้ำ เย็นเพื่อเร่งอัตราการเกิดครีมแล้วจึงนำเก็บในห้องเย็นเพื่อให้เกิดการเซตตัว พบว่า ต้องเก็บเป็นเวลา 2 วันกับครีมน้ำผึ้งดอกทานตะวัน และครีมน้ำผึ้งดอกกล้วย และเก็บเวลา 6 วันสำหรับครีมน้ำผึ้ง ดอกไม้ป่า จึงจะได้เนื้อสัมผัสเป็นไปตามค่าที่ต้องการเท่ากับ 12 -15 N วางน้ำผึ้งที่อุณหภูมิต่ำเพื่อให้ ได้เนื้อสัมผัสนุ่ม ง่ายต่อการกระจาย เป็นเวลา 1 วัน ครีมน้ำผึ้งทุกชนิดสามารถเก็บที่อุณหภูมิต่ำ (18-22°C) ได้นานถึง 6 เดือนโดยไม่เกิดการเปลี่ยนแปลงสภาพ

แบบจำลองทางคณิตศาสตร์ของอะวรามิที่ได้จากการเปลี่ยนแปลงของค่าการดูดกลืนแสง ที่ความยาวคลื่น 660 นาโนเมตรกับเวลา สามารถใช้อธิบายลักษณะการตกผลึกของน้ำผึ้งเมื่อกระตุ้น ด้วยการเติมกลูโคสและเก็บที่อุณหภูมิเย็นได้เป็นอย่างดีเหมาะสม กระบวนการที่พัฒนาใช้เวลาในการ ผลิตเท่ากับ 40 นาที ซึ่งน้อยกว่าการผลิตแบบวิธีการไคซ์ (70 นาที) สามารถเพิ่มประสิทธิภาพได้ 40% และเมื่อเปรียบเทียบกับระยะเวลาการทำให้ครีมนุ่ม จะสามารถลดเวลาการเก็บรักษาจาก 19 วัน เหลือเพียง 3 วัน ซึ่งทำให้ประสิทธิภาพการผลิตเพิ่มขึ้นถึง 84.21% และเมื่อทำการออกแบบ เครื่องต้นแบบผลิตครีมน้ำผึ้งตามกระบวนการที่พัฒนาการตกผลึกแบบควบคุมด้วยคลื่นอัลตราโซนิค แล้วประเมินเศรษฐศาสตร์วิศวกรรมและวิเคราะห์ต้นทุนจะได้รับจุดคุ้มทุนที่ราคาจำหน่ายเครื่อง 450,000 บาท เมื่อผลิตปริมาณครีมน้ำผึ้งมากกว่า 1,500 กิโลกรัมหรือได้มูลค่าการขายที่มากกว่า 1,500,000 บาทขึ้นไป

คำสำคัญ : น้ำผึ้งไทย, ครีมน้ำผึ้ง, กระบวนการตกผลึก, อัลตราโซนิค, แบบจำลองทางคณิตศาสตร์

<b>Title</b>	THAI CREAMED HONEY DEVELOPMENT BY CONTROL OF CRYSTALLIZATION PROCESS WITH ULTRASONIC TREATMENT
<b>Author</b>	Mrs. Voraluck Suriwong
<b>Degree</b>	Doctor of Engineering in Food Engineering
<b>Advisory Committee Chairperson</b>	Associate Professor Dr. Somkiat Jaturonglumlert

### ABSTRACT

Thai honey is a naturally sweet and supersaturated sugar solution consisting of mainly glucose and fructose, and there are many types of Thai honey. In most honey, the excess glucose is cause of crystallization which is unacceptable to consumers and crystallization will produce the non-uniform crystal, and gritty texture. The control of crystallization for producing in a creamed honey product can increase the market value, and it is a very interesting product for developing for the honey industry in Thailand. However, the process is not easy to produce, especially in the crystallization process. Ultrasonic is an efficient tool for enhancing and controlling crystallization. Therefore, this research aims to improve Thai creamed honey process by control of crystallization with ultrasonic treatment to obtain a smooth texture. The optimal creamed honey process was investigated by concerning the factors that affect the crystallization and the quality of creamed honey with enhance for the final product stability, suitable storage condition, and final product stability were then studied. Finally, the crystallization model of creamed honey investigated for better control the texture of product and design creamed honey model prototype with food engineering design concept and economic analysis.

The glucose per water ratio (G/W ratio) is the main parameters to distinguish the control of honey crystallization and showed that sunflower honey got the value not less than 2.16, in contrast, longan and wild honey is lower than 1.70. It

confirmed that sunflower honey is rapid crystallization and longan and wild honey is slow or non-granulating honey. The suitable method for increasing the G/W ratio in non-granulating honey and unaffected with honey properties is the glucose addition.

The control of crystallization process with ultrasonic treatment of creamed honey is starting from liquid honey is heated with ultrasonic treatment at 40 kHz (55°C, 30 mins) for pasteurizing and clearing any crystals. Then, the liquid honey is rapidly cooled down in the rate of 6.5°C/min for taking the honey temperature to reduce to below 20°C in the least time. The amount of seed addition is approximately in the range of 7.50 – 15.0%, depends on the G/W ratio. Rapid agitating not over than 1,300 rpm has been fully incorporated into the liquid honey and treated with ultrasonic at 40 kHz, intensity 0.15 Watt/cm<sup>2</sup> for 5 mins as post-treatment. The storage time for obtaining a firm texture (hardness value is 12 – 15 N) is 2 days in creamed sunflower and longan honey, and 6 days for creamed wild honey, and further place in room temperature for 1 day for easy to spread or a soft texture. The stability of a product is the product shelf-life guarantee in creamy product. Almost creamed honey can keep in low temperature (18-22°C) without any variation of stability for more than 6 months.

Monitoring of honey crystallization kinetic from the absorbance measurement at 660 nm and simulating with the Avrami equation were the suitable model for explain the crystallization behavior of honey. The developed method's total processing time is about 40 mins, enhancing efficiency into 40% by comparing with Dyce's method (70 mins) and the storage time reduced from 19 days to 3 days. Finally, the creamed honey maker model prototype presented and design as following developed process by control of crystallization process with ultrasonic treatment. The economic analysis and break-even analysis were evaluated and could be the machines' sales price equal to 450,000 THB. The profit attributed to the sales volume got higher than 1,500 kg of creamed honey product.

Keywords : Thai honey, Creamed honey, Crystallization, Ultrasonic, Mathematical model





## ACKNOWLEDGEMENTS

First, I would like to express my gratitude and sincerely appreciate to my supervisor, Assoc. Prof. Dr. Somkiat Jaturonglumert for great opportunities, guidance, supervisions, valuable suggestions and all supports throughout my D.Eng study. Second, I would like to give a special thank to the committee, Assoc. Prof. Dr. Jaturapatr Varith, Asst. Prof. Dr. Kanjana Narkprasom, Asst. Prof. Dr. Chanawat Nitatwichit, and Asst. Prof. Dr. Yardfon Tanongkankit for all kind advices, helpful suggestions and valuable information of this thesis, including Asst. Prof. Dr. Srisuwan Naruenartwongsakul, external committee as the chairperson. I have learned an incredible amount during my study.

Most importantly I would like to acknowledge Thai Government Science and Technology Scholarship support provided by the Ministry of Science and Technology (MOST), Thailand for awarding the scholarship through Pibulsongkram Rajabhat University. I would like to thank Mr. Somchai Injorhor, academic staff of National Science and Technology Development Agency for all helps and supports through my study.

I would like to thank all supports of secretaries and technical staffs of Department of Food Engineering in Faculty of Engineering and Agro-Industry, Institute of Product Quality and Standardization (IQS) and Graduate School, Maejo University. Grateful thanks to Faculty of Food and Agricultural Technology, Pibulsongkram Rajabhat University for research facilities and helpful support. Many thanks to my classmates, lab members and friends for their help, support and cheer.

Finally, I would like to give thank my parents, my brother and my family, Mr. Tawat Suriwong, Ms. Krityakorn and Ms. Naphapat Suriwong, my husband and daughter for their love, kindness, support and encourage me at all time.

Voraluck Suriwong

## TABLE OF CONTENTS

	Page
ABSTRACT (THAI).....	C
ABSTRACT (ENGLISH).....	D
ACKNOWLEDGEMENTS.....	G
TABLE OF CONTENTS.....	H
CONTENT OF TABLES.....	M
CONTENT OF FIGURES.....	O
CHAPTER 1 INTRODUCTION.....	1
1.1 Background and significance of research.....	1
1.2 Research objective.....	4
1.3 Scope of the study.....	4
1.4 Keywords.....	4
1.5 Statements of originality.....	4
CHAPTER 2 LITERATURE REVIEW.....	5
2.1 Honey and composition of honey.....	5
2.1.1 Chemical properties of honey.....	8
2.1.2 Physical properties of honey.....	13
2.2 Crystallization of Honey.....	17
2.2.1 Crystallization mechanism.....	18
2.2.2 Factors affecting with crystallization of honey.....	21
2.2.3 Related literature reviews of crystallization in honey:.....	22
2.3 Control of crystallization.....	23

2.3.1 Factors affecting control of crystallization .....	25
2.4 Creamed honey .....	27
2.4.1 Creamed honey production .....	27
2.4.2 Factor affecting crystallization control in creamed honey .....	29
2.5 Processing techniques involving with creamed honey .....	34
2.5.1 Dehydration techniques in honey .....	34
2.5.2 Heat processing techniques in honey .....	35
2.5.3 Heat treatment during honey processing .....	36
2.6 Ultrasonic treatment in food processing.....	37
2.6.1 Ultrasonic application with crystallization process.....	39
2.6.2 Control of crystallization process with ultrasonic treatment in honey.....	41
2.7 Mathematical model involving crystallization behavior .....	47
2.7.1 Crystal growth kinetics .....	50
2.7.2 Crystalline systems.....	52
2.7.3 Activated nucleation .....	54
2.7.4 Crystal growth.....	55
2.7.5 Crystal growth and heat effects.....	57
CHAPTER 3 METHODOLOGY .....	60
Material and method .....	60
3.1 To study the possibility to produce creamed honey product from various types of honey in Thailand.....	63
3.1.1 To study the honey properties and natural crystallization .....	64
3.1.2 To study the effect of moisture and glucose content to the honey crystallization .....	64

3.2 To develop a suitable method to produce creamed honey product.....	70
3.2.1 To study the creamed honey production by Dyce's method.....	70
3.2.2 To study the enhancing crystallization with ultrasonic treatment .....	71
3.2.3 To determine the optimal cooling condition .....	73
3.2.4 To determine the optimal amount of seed addition and speed of agitation.....	73
3.2.5 To study the effect of ultrasonic treatment on post-treatment.....	75
3.2.6 To investigate the storage condition and product shelf-life .....	76
3.2.7 To establish the developed method for creamed honey production.....	78
3.3 To study the crystallization behavior and improve the model to explain the crystallization of creamed honey.....	78
3.4 To conceptually design the prototype for creamed honey machine and study the economic analysis.....	78
CHAPTER 4 RESULT AND DISCUSSION .....	80
4.1 The possibility to produce creamed honey product from various types of honey in Thailand.....	80
4.1.1 The relation between physicochemical properties and crystallization behavior of various types honey in Thailand .....	80
4.1.2 Effect of moisture and glucose content to the crystallization behavior of honey .....	84
4.2 Develop suitable process to produce creamed honey product.....	96
4.2.1 Creamed honey process by Dyce's method .....	96
4.2.2 The enhancing crystallization with ultrasonic treatment in pre-heat process.....	101
4.2.3 The optimal cooling condition.....	107
4.2.4 The optimal amount of seed addition and speed of agitation .....	109

4.2.5 Effect of ultrasonic in post-treatment.....	117
4.2.6 Effect of storage condition and the product shelf-life .....	121
4.2.7 The conclusion of developed method of creamed honey product .....	128
4.3 The crystallization model and improve the model to predict the crystallization behavior of creamed honey.....	132
4.3.1 Crystallization model in crystallized honey induced with glucose powder .....	132
4.3.2 Crystallization model in creamed honey with ultrasonic treatment.....	141
4.4 Food engineering innovation concept design .....	144
4.4.1 Food innovation concept design.....	144
4.4.2 Economic Analysis .....	160
CHAPTER 5 CONCLUSION .....	165
5.1 General conclusion .....	165
5.1.1 Effect of glucose and moisture content to the honey crystallization.....	165
5.1.2 The suitable process to produce creamed honey product.....	165
5.1.4 The crystallization model for creamed honey.....	166
5.1.5 Food engineering innovation concept design.....	166
5.2 Recommendation.....	167
5.3 Novelty of this research.....	167
REFERENCES .....	168
APPENDIX.....	176
APPENDIX A MATLAB script.....	177
Crystallization kinetic by MATLAB program.....	178
GUI program for monitor display of creamed honey maker .....	179

APPENDIX B Thermal phenomena by DSC.....	181
Differential Scanning Calorimetry analysis.....	182
Thermogram of honey and creamed honey .....	183
APPENDIX C Research Publication I.....	186
APPENDIX D Research Publication II.....	195
APPENDIX E Research Publication III .....	226
CURRICULUM VITAE.....	243



## CONTENT OF TABLES

	Page
Table 1 Mean amounts (% of total honey) of constituents of honey .....	6
Table 2 Chemical properties of sunflower, longan, sub sua and lychee honey .....	7
Table 3 Carbohydrate contents (and/or range) of honeys in different countries.....	9
Table 4 Enzymes in honey .....	12
Table 5 Specific heat of honey .....	17
Table 6 Characters associated with crystal shape of industrial importance.....	19
Table 7 Reviews of seed addition.....	31
Table 8 Reviews of storage temperature in honey .....	32
Table 9 Reviews of storage temperature in honey (Continue).....	33
Table 10 Reviews of ultrasonic treatment with honey .....	44
Table 11 Reviews of ultrasonic treatment with honey (Continue).....	45
Table 12 Reviews of ultrasonic treatment with honey (Continue).....	46
Table 13 Definition of creamed honey texture.....	74
Table 14 Moisture content and sugar composition (%) of Thai honey .....	82
Table 15 Colour and water activity ( $a_w$ ) analysis of longan honey before and after dehydration by vacuum far-infrared and hot air oven at different condition .....	87
Table 16 Biochemical compositions (g/100 g) of honey samples.....	88
Table 17 Full crystallization time and the absorbance value of crystallized honey resulted from adding glucose powder; 1.0, 1.5, 2.0, and 2.5 (%w/w) to liquid sunflower and longan honey. ....	93
Table 18 The heating time and the effect of heating on HMF and colour.....	104
Table 19 The relation of seeding addition and storage time in each honey type .....	113

Table 20 The amount of seed addition in each honey type for produce creamed honey product within 1 week.....	115
Table 21 The suitable storage time in each creamed honey type.....	121
Table 22 The consistency of creamed honey during keeping in room temperature	124
Table 23 Transition temperature ( $T_{onset}$ , $T_{midpoint}$ ), enthalpy of crystal melting ( $\Delta H_m$ ), peak of temperature ( $T_{peak}$ ) and enthalpy of sugars fusion ( $\Delta H_f$ ) of liquid and creamed honey in three types: sunflower, longan and wild honey. ....	125
Table 24 Overall processing time comparing between Dyce's method and developed method.....	131
Table 25 First order parameters ( $\alpha$ and $\beta$ ) and statistical parameters of crystallized honey resulted from adding glucose powder to liquid sunflower and longan honey. ....	133
Table 26 Avrami parameters ( $k$ and $n$ ) with standard deviation (S.D.) and statistical parameters of crystallized honey resulted from adding glucose powder; 1.0, 1.5, 2.0, and 2.5 (%w/w) to liquid sunflower and longan honey.....	140
Table 27 Avrami parameters ( $k$ and $n$ ) and statistical parameters of creamed sunflower, longan and wild honey resulted from seed honey addition (5.0% - 17.5%w/w).....	143
Table 28 The assembly details and cost of creamed honey maker with ultrasonic.	160
Table 29 Production capacity of creamed honey maker.....	162
Table 30 The economic analysis of creamed honey maker and payback period.....	164



## CONTENT OF FIGURES

	<b>Page</b>
Figure 1 Mechanism of HMF formation from glucose and fructose .....	11
Figure 2 CIE chromaticity diagram .....	15
Figure 3 CIELAB colour space.....	15
Figure 4 Key concepts in crystallization.....	19
Figure 5 Hypothetical crystallization rate of honey with respect to the temperature	20
Figure 6 The procedure of honey cream production by Dyce method (1931).....	28
Figure 7 Creamed honey.....	29
Figure 8 Cavitation phenomenon.....	38
Figure 9 Schematic diagram of reduction in the metastable zone using ultrasonic ....	40
Figure 10 Various kinds of nucleation .....	54
Figure 11 Concentration profiles for growth that is limited by diffusion or integration .....	55
Figure 12 Flow chart of overall research methodology .....	65
Figure 13 Glucose powder addition method.....	68
Figure 14 Process flow chart of creamed honey by Dyce's method .....	71
Figure 15 Schematic diagram of creamed honey production with ultrasonic.....	72
Figure 16 Appearance of liquid Thai honey;.....	83
Figure 17 Honey appearance during keeping chilled temperature (10-14°C), .....	83
Figure 18 The dehydration curve of longan honey.....	85
Figure 19 G/W ratio variation with dehydration time of longan honey .....	86
Figure 20 Natural crystallization of sunflower and longan honey .....	90

Figure 21 Appearance in cuvette of sunflower and longan honey.....	91
Figure 22 Absorbance at 660 nm of, (A) natural crystallization behavior, and (B) the crystallization behavior was induced with glucose addition of sunflower.....	92
Figure 23 The color value of $L^*$ value, hue angle ( $h^\circ$ ) and Whiteness Index ( $WI$ )	95
Figure 24 Creamed sunflower honey by Dyce's method .....	97
Figure 25 Texture profile of creamed sunflower honey by Dyce's method .....	99
Figure 26 Appearance of creamed sunflower honey product by Dyce's method .....	99
Figure 27 Airborne Manuka and Wildflower cream honey, Airborne honey guardians, .....	100
Figure 28 Target hardness value (N) of creamed honey product.....	100
Figure 29 Heating honey by heating bath .....	101
Figure 30 Schematic diagram of heating and ultrasonic treatment.....	102
Figure 31 Heating and ultrasonic treatment at 100 Watt power, frequency 40 kHz..	102
Figure 32 Honey temperature profile at 55°C comparing between heating with ultrasonic 45 kHz and heating bath.....	103
Figure 33 Honey after heating by developed method and Dyce's method.....	105
Figure 34 Microscopic observation of honey crystals before heating with ultrasonic treatment .....	106
Figure 35 Microscopic observation of honey after heating with ultrasonic treatment .....	106
Figure 36 Honey temperature profile in different cooling rate.....	108
Figure 37 Honey temperature profile during rapid cooling rate at 6.50°C/min.....	109
Figure 38 Effect of seed addition on texture profile during keeping in chilled temperature.....	111

Figure 39 Creamed sunflower honey appearance in different amount of seed addition .....	112
Figure 40 the appearance of creamed honey in different type .....	114
Figure 41 Speed of agitation for mixing the cooled liquid honey and seed honey... 115	
Figure 42 Non-homogeneous creamed honey by slow agitation at 100-300 rpm .....	116
Figure 43 Homogeneous creamed honey by rapid agitation at 1,000 – 1,300 rpm ... 116	
Figure 44 Creamed sunflower honey after agitation test at > 1,300 rpm .....	117
Figure 45 the mixed honey was treated with ultrasonic at 40 kHz and 0.15 Watt/m <sup>2</sup> .....	118
Figure 46 Effect of ultrasonic treatment on the metastable zone width (MZW) of crystallization in creamed honey .....	119
Figure 47 Small glass crystals contained in creamed honey product.....	120
Figure 48 Creamed honey appearance of (A) sunflower honey (B) longan honey (C) wild honey (D) commercial creamed honey .....	120
Figure 49 The spreadability observation of creamed honey.....	122
Figure 50 Creamed honey product stored in 28-30°C in day 90 .....	123
Figure 51 DSC thermograms of creamed (A) sunflower, (B) longan and (C) wild honey .....	126
Figure 52 Creamed honey product in 18-22°C in 6 months.....	128
Figure 53 Developed process of Thai creamed honey product .....	129
Figure 54 Temperature profile of creamed honey process comparing between developed method and Dyce's method .....	130
Figure 55 Experiment (exp) and modelled (model) data of <i>XtX0</i> obtained with the empirical model of sunflower honey with glucose addition (%w/w) .....	134

Figure 56 Experiment (exp) and modelled (model) data of $XtX0$ obtained with the empirical model of longan honey with glucose addition (%w/w).....	134
Figure 57 Nonlinear regression for crystallization kinetic from Avrami equation by MATLAB program (sunflower honey).....	137
Figure 58 Nonlinear regression for crystallization kinetic from Avrami equation by MATLAB program (longan honey).....	137
Figure 59 Experiment (exp) and modeled (model) data of relative crystallized fraction $X(t)$ obtained with the Avrami equation.....	139
Figure 60 Experiment (exp) and modeled (mod) data of relative crystallized fraction $X(t)$ obtained with the Avrami equation of Thai creamed honey.....	142
Figure 61 Creamed honey process.....	145
Figure 62 Comparative of creamed honey process between Dyce's method and developed method.....	146
Figure 63 The creamed honey process from lab-scale to 100 L creamed honey machine prototype model.....	147
Figure 64 Schematic diagram of Creamed honey Maker model prototype.....	151
Figure 65 Assembly view of creamed honey maker (Tank).....	152
Figure 66 Assembly view of creamed honey maker (Overall view).....	153
Figure 67 Assembly view of creamed honey maker (Back view).....	154
Figure 68 Assembly view of creamed honey maker (side view-1).....	156
Figure 69 Assembly view of creamed honey maker (side view-2).....	157
Figure 70 Assembly view of creamed honey maker (Top view).....	158
Figure 71 Screen example of a MATLAB program to design a creamed honey process.....	159
Figure 72 Break – Even Chart.....	163

# CHAPTER 1

## INTRODUCTION

### 1.1 Background and significance of research

Honey is a natural sweet, viscous food substance produced by bees and some related insects. The variety of honey produced by honey bees (the genus *Apis*) is the best known, due to its worldwide commercial production and human consumption. It consists of fructose, glucose, water, maltose and other constituents. With both fructose and glucose, the high solubility of fructose means that glucose is the component that limits the crystallization rate when honey is cooled (Van Den Berg, 1998). It is a common problem within the honey industry for heat-treated liquefied honey to crystallize during storage, particularly during cold weather like weather in Northern part of Thailand.

In the last decade, floral honey industries in the Northern part of Thailand produced a wide range of honey varieties for both domestic and export markets (Chaikham et al., 2016). The honey products in Thailand were many categories such as liquid honey, candied honey, and royal jelly. According to a report of the department of Agriculture Extension, Ministry of Agriculture and Cooperatives of Thailand, Thai honey production in 2019 was over 10,000 t, 70% of which were exported. Three types in Thai honey (sunflower, longan, and wild honey) have large production capacity in Thailand and cannot be sold at a high price. Due to longan honey has a strong fruity scent and unique taste with dark brown color, it is almost impossible to further develop it into another food product; hence, almost all longan honey found in Thailand markets is pure liquid longan honey. In addition, sunflower honey is the honey's type in Thailand which is not easy to produce in pure liquid honey because the composition of it composed of high glucose concentration. It is a yellow light color and tends to crystallize during storage. Therefore, sunflower honey might easily be produced into a creamed honey product and has a chance of Thailand's honey industries.

One such product which would likely be popular and interesting in Thailand which can increase the market value is creamed honey. However, creamed honey product is not easy to produce because much of it is a gritty, coarsely crystallized product and some of it is unpleasantly crunchy. Moreover, creamed honey production was not easy procedure to control, especially in crystallization process which is related with the size of the glucose monohydrate crystals and many times that incident of creamed honey product was not smooth texture, it is either too hard or too soft for a nice spread.

Creamed honey is a favorite product with many peoples, because it has a thicker texture than liquid honey and has a much longer shelf-life than normal honey. The taste is unique flavors when compared with the taste of raw or natural honey. There are many ways of enjoying nutritious honey such as, creamed honey on sliced pears or apples, creamed honey on sharp cheddar cheese with your favorite wine, creamed honey on hot sweet potatoes, creamed honey on hot tea or coffee, creamed honey spread on bread, and, of course, creamed honey is a wonder nutritious alternative to butter and syrup on toast or pancakes. However, creamed honey is not common in Thailand, mainly because most beekeepers cannot produce it or cannot produce in good texture. Therefore, if we can develop creamed honey product which had a smooth texture from various types or various grades of Thai honey, it will be the better way or the best choice for beekeepers and honey bee industry.

Normally, creamed honey is sold under quite a few names: honey cream, honey spread, granulated (not a very pretty word) honey, honey butter (a poor choice unless it actually contains butter), and perhaps other names. The texture of the creamed honey should be such that they cannot be felt in the mouth. It should feel like butter smooth. Creamed honey is a liquid honey that has undergone the processing technique of controlled crystallization to obtain a smooth and spread ability. Therefore, the crystallization is one of the most important criterion of creamed honey production. Regarding to creamed honey is not whipped honey, so there should not be any air in its and it is controlled granulation of honey which results in extremely small sugar crystals. The smaller the crystals, the better the

creamed honey. A good creamed honey should be smooth, not grainy, like velvet on the tongue. Therefore, to enhance creamed honey texture, the liquid honey or crystallized honey should dissolve the crystals or any particles by mild-heat treatment before further produce in honey cream.

The standard method was invented and described by Dyce (1931a, b) to produce creamed honey which was following about eight to nine procedures. It started from heating or pasteurization of liquid honey and cool it down, seeding addition and agitating was done after that and finally it will be packed in the suitable package and keep in suitable temperature. As following method, there were many steps which should be investigate and conclude in optimal condition for obtain the best texture of product. Regarding the desired crystalline structure provides a characteristic texture to the product and the crystals provide an element of structure in the product, so the correct number, size (and distribution), shape and polymorph of crystals is required to provide the desired processing characteristics, quality (texture, flavor, etc.), appearance and shelf stability of the product (Myerson, 2002). The most important phenomenon for controlling the crystal size distribution is nucleation, and the kinetics of nucleation and growth must be controlled, through proper choice of formulation and processing conditions, to give the desired crystalline microstructure, therefore the crystallization behavior and the kinetic of crystallization should be study.

Thus, this research project was aim to improve Thai honey by investigate physicochemical properties and study the raw material preparation before further produce in creamed honey product, and investigate if it was possible to applied the ultrasonic treatment in the process for saving energy without effecting with creamed honey qualities. In addition, the optimal creamed honey process was investigated with respect to the factors that affect the crystallization and the quality of creamed honey with enhance for the final product stability. The suitable storage condition and the stability of finished product were then studied. Finally, the crystallization behavior of honey should be investigated to improve the crystallization model for better control the texture of product and design creamed honey model prototype with food engineering design concept and economic analysis.

## 1.2 Research objective

1. To study the possibility to produce creamed honey product from various types of honey in Thailand.
2. To develop a suitable method to produce creamed honey product.
3. To study the crystallization behavior and improve the crystallization model of creamed honey.
4. To conceptually design the prototype of creamed honey machine and study the economic analysis.

## 1.3 Scope of the study

1. Honey samples were used only Thai honey and all honeys were purchased from Supha Bee Farm, Chiang Mai province, Thailand, with a guarantee type, origin, and known history.
2. The economic analysis study will conduct as 100 - 150 Liters.

## 1.4 Keywords

Thai honey, Creamed honey, Crystallization, Ultrasonic, Mathematical model.

## 1.5 Statements of originality

This thesis is the result of my own work and includes nothing which is the outcome of work done in concept by the application of ultrasound to a crystallization in creamed honey process. Ultrasonic treatment appears to offer significant for improving both processes and products as power and offers an additional, highly flexible method of control and bring the following advantages including narrowing of the metastable zone width (MZW), controlling initiation of nucleation, improvement in crystal shape and habit, processing time reduction and improving product properties including handling and appearance.



## CHAPTER 2

### LITERATURE REVIEW

The natural substance produced by honeybee in almost every country of the world is called honey, from nectar of plants, as well as from honeydew. Honey is mainly composed of a complex mixture of carbohydrates, sugars, and other minor constituents such as amino acids, organic acids, carotenoids, vitamins, minerals, proteins, enzymes, mainly invertase, glucose oxidase, catalase and phosphatases, lipids, volatile chemicals, phenolic acids, flavonoids and aromatic substances (Ajlouni and Sujirapinyokul, 2010; D'Arcy, 2007; Da Silva et al., 2016; Doner, 1977; Saxena et al., 2014).

The composition of honey depends not only on the plant species pollinated by the honeybees and the climatic, but also the processing and storage conditions. Moreover, honey is the most abundant with monosaccharides sugar, which are fructose and glucose approximately 70 – 85% of the honey solids, and present small quantities of disaccharides (maltose and sucrose), trisaccharides and oligosaccharides.

The main component that crystallizes in honey is glucose because of its existence in the supersaturated state (Costa et al., 2015). Moreover, honey is a highly concentrated aqueous solution of glucose and fructose along with small amount of different other higher sugars (Alvarez-Suarez et al., 2010). Although honey is more complex than the model systems examined to date, but valuable information has been gained by examining the roles of the major components of honey (glucose, fructose, and water) in the crystallization of glucose (Doner, 1977). Moreover, it is a viscous-sweet food traditionally consumed by people around the world, and of great benefit to humans begins both of medicine and food.

#### 2.1 Honey and composition of honey

Honey is a food that contains about 200 substances and consists mainly of sugars, water, and other substances such as proteins (enzymes), organic acids, vitamins (especially vitamin B6, thiamine, niacin, riboflavin and pantothenic acid),

minerals, pigments, phenolic compounds, a large variety of volatile compounds, and solid particles derived from honey harvesting. The composition, color, aroma and flavor of honey depend mainly on the flowers, geographical regions, climate and honeybee species involved in its production, and are also affected by weather conditions, processing, manipulation, packaging and storage time (Da Silva et al., 2016). The composition of honey depends on the varieties of flowering plants that nectar is collected from and environmental conditions. Therefore, the composition of honey types produced in the world is variable. Honey is composed of sugars and water making up 99% of most honeys and the remaining 1% consists of enzymes, aroma constituents, organic acids, minerals and other substances (D'Arcy, 2007).

**Table 1** Mean amounts (% of total honey) of constituents of honey

Constituent	Range (%)
Fructose	21.7 – 53.9
Glucose	20.4 – 44.4
Water	13.4 – 26.6
Disaccharides (as maltose)	2.7 – 16.0
Higher sugars	0.1 – 8.5
Total acids (as gluconic)	0.17 – 1.17
Sucrose	0.0 – 7.6
Minerals	0.02 – 1.03
Nitrogen (in amino acids and proteins)	0.00 – 0.13

**Source:** adapted from Crane (1990) and D'Arcy (2007).

Some information present glucose and fructose (invert sugars) are the principal sugars in honey, accounting for 33 – 35% and 38 – 40%, respectively. Fructose content is normally higher than glucose, although some exceptions have been reported (Bhandari et al., 1999). Summarized of constituents of honey were shown in percentage of mean amounts of total honey as shown in Table 1.

Floral honey products in the Northern part of Thailand produced a wide range of honey varieties for both domestic and export markets such as longan

honey, sunflower honey, sab sua honey, wildflower honey. The type of honey depends on the type of flower and Thailand is a land rich in beautiful flowers, also it is a source of good quality honey that is famous all over the world such as longan flower honey or longan honey, sunflower honey, wildflower honey or wild honey and lychee flower honey.

Some researchers reported the compositions of Thai honeys are shown in Table 2.

**Table 2** Chemical properties of sunflower, longan, sub sua and lychee honey

Constituent	Honey type			
	Sunflower honey	Longan honey	Sab sua honey	Lychee honey
Solids (%)	80.5	79.0	80.0	
Ash (%)	0.11	0.07	0.09	0.16
pH	3.53	4.49	3.84	3.49
Moisture content (%)	19.5	21.0	20.0	19.97
Water activity ( $a_w$ )	0.52	0.53	0.52	-
Titrateable acidity (%)	0.06	0.02	0.03	27.84
Fructose (%)	40.66	43.89	48.54	29.86
Glucose (%)	32.1	33.85	31.13	28.70
Maltose (%)	7.67	1.26	0.33	-
Sucrose (%)	<0.1	<0.1	<0.1	0
Nitrogen (%)	0.06	0.05	0.06	-
Fructose/Glucose ratio	1.27	1.30	1.56	1.01
Glucose/Water ratio	1.65	1.61	1.56	1.44

**Source:** adapted from Srinual (2007) and Wanjai et al. (2012)

- Sunflower honey is bright yellow color, and almost will quickly crystallize after harvest. The crystal is yellowish and smooth, beautiful and homogeneous appearance.

- Longan flower honey or longan honey will almost light brown or brown, it can be kept for a long time without evaluation of color. Moreover, it is composed of

low content of glucose, it seems to be non-granulating honey or cannot occur crystallization although in chilled storage.

- Wildflower honey or wild honey will be yellowish brown and look like longan honey. However, it may crystallize in chilled temperature during storage.

- Lychee flower honey is amber yellow and did not change in color during storage. It is mellow sweet taste; however, it is easy to crystallize during keeping in cold storage.

### **2.1.1 Chemical properties of honey**

The varieties of flowering plants that nectar is collected from and environmental conditions were impact with the chemical composition of honey. Therefore, the chemical composition of honey types produced in the world is variable.

#### **1) Carbohydrates in honey**

Honey consists of a mixture of carbohydrates. Glucose and fructose are monosaccharides that make up 65 - 75% of the total soluble solids and 85 - 95% of the honey carbohydrates (D'Arcy, 2007). Sugars in honey are including in monosaccharides such as glucose and fructose, followed by disaccharides such as sucrose, maltose, turanose, isomaltose, maltulose, trehalose, nigerose. Disaccharides and trisaccharides are hydrolyzed enzymatically to monosaccharides.

Survey of floral honey composition have established that the three major components which were fructose, glucose, and water was average about 38.2%, 31.3% and 17.2%, respectively and about 85% of the honey solids which is the major constituents of honey is glucose and fructose (Doner, 1977).

Monosaccharides represent about 75% of the sugars found in honey, along with 10 – 15% disaccharides and small amounts of other sugars. The sugars present in honey are responsible for properties such as energy value, viscosity, hygroscopicity and granulation. The concentration of fructose and glucose, as well as the ratio between them, are useful indicators for the classification of monofloral honeys (Da Silva et al., 2016). The fructose to glucose ratio is a characteristic of some honeys.

Sucrose is a disaccharide that comprises 1 - 3% of the composition of honey, and consists of fructose and glucose units linked together by a glycosidic bond.

Trisaccharides consist of three simple sugar subunits and oligosaccharides contain more than three sugar units. These are formed from mono and disaccharides (D'Arcy, 2007). Carbohydrates contents (and/or range) of honeys in different countries is shown in Table 3.

**Table 3** Carbohydrate contents (and/or range) of honeys in different countries

Country	Total reducing sugars % (Range)	Glucose % (Range)	Fructose % (Range)	Sucrose % (Range)	Maltose % (Range)
Thailand	- 85.0 – 94.9	31 20.4 – 44.4	38.5 21.7 – 53.9	1.5 0.0 – 7.6	7.2 2.7 – 16.0
India	- -	35.7 34.2 – 39.2	39.3 36.8 – 40.5	0.6 0.3 – 1.0	- -
Japan	69.2 60.5 – 76.1	32.6 22.2 – 38.6	36.0 30.0 – 48.5	2.83 1.0 – 5.8	- -
Korea	- -	23.6 24.0 – 29.9	30.9 29.6 – 33.4	1.63 0.87 – 3.57	2.68 1.97 – 3.80
Nepal	- -	41.95 36.3 – 46.3	45.9 42.3 – 50.4	1.96 0.0 – 7.80	3.26 1.61 – 4.13
Taiwan	- -	28.7 17.1 – 36.2	23.5 20.7 – 46.8	- -	- -

**Source:** adapted from Crane (1990) and D'Arcy (2007)

Note: Single values are averages; others are ranges; and, - indicates data were not included in the publication.

## 2) Moisture content and water activity ( $a_w$ )

The moisture of honey in the comb is that remaining from the nectar after ripening and the amount of moisture is a function of the factors involved in ripening, weather conditions and original moisture of the nectar. Thus, its moisture content may change after honey extraction, depending on conditions of storage. It is one of

the most important characteristics of honey influencing keeping quality, granulation, and body (White and Doner, 1980).

Water is the second largest constituent of honey. Its content may vary from 15 to 21 g 100 g<sup>-1</sup> depending on the botanical origin of the honey, the level of maturity achieved in the hive, processing techniques and storage conditions (Da Silva et al., 2016). The moisture content plays an important role in the stability of honey in relation to fermentation and granulation during storage (D'Arcy, 2007). It is influencing physical properties of honey such as viscosity and crystallization, as well as other parameters: color, flavor, taste, specific gravity, solubility and conservation.

The moisture content may range between 13% and 25%. Normally, if honey has more than 17% moisture and contains a sufficient number of yeast spores, it will ferment. So, honey should be pasteurized, that is, heated sufficiently to kill such organisms. This is particularly important if the honey is to be “creamed” or granulated, since this process results in a slightly higher moisture level in the liquid part (White and Doner, 1980).

The crystallization of glucose in honey leads to the reduction of soluble solids resulting in the dilution of the amorphous solution, which therefore increases the water activity. Honey usually has  $a_w$  between 0.50 and 0.65, and  $a_w$  values above 0.60 represent a critical threshold for microbial stability. Although there are no limits imposed by the standards, it is known that the value of  $a_w$  is very important, because honey contains osmophilic yeasts that can cause fermentation, forming ethyl alcohol and carbon dioxide, thereby changing the quality of the honey (Da Silva et al., 2016).

The moisture content is the only composition criteria, which as a part of the Honey Standard has to be fulfilled in world honey trade. Honey having a high water content is more likely to ferment.

### 3) Hydroxymethylfurfural content in honey

Hydroxymethylfurfural (HMF) formation results from the acid catalyzed dehydration of hexose sugars with fructose being particularly susceptible to this reaction. In fresh honey present only small amounts (0.06 – 0.20 mg/100 g) (Doner, 1977). Hydroxymethylfurfural (HMF) is produced by acid catalyzed dehydration of

hexoses. Glucose and fructose in honeys decompose in the presence of gluconic acid to form HMF. This process is reported to be enhanced by heat or storage under elevated temperatures. Honey is heated at different stages of its processing to reduce viscosity, destroy yeast, and dissolve crystals. However, such heat treatments increase the HMF content of honey. Therefore, HMF content can be used as an indicator to detect the heat damage and adulteration of honey. Further, it has been reported that the HMF content of honey increases during storage in the warm climates of tropical and subtropical countries. The latest Codex standards for the HMF content of honey is set as less than 40 mg/kg after processing and/or blending of honey. However, a standard for HMF of less than 80 mg/kg has been set for the honeys produced in countries or regions with tropical ambient temperatures and in blends of these honeys (CODEX and INTERGOVERNMENTAL, 2001; D'Arcy, 2007).

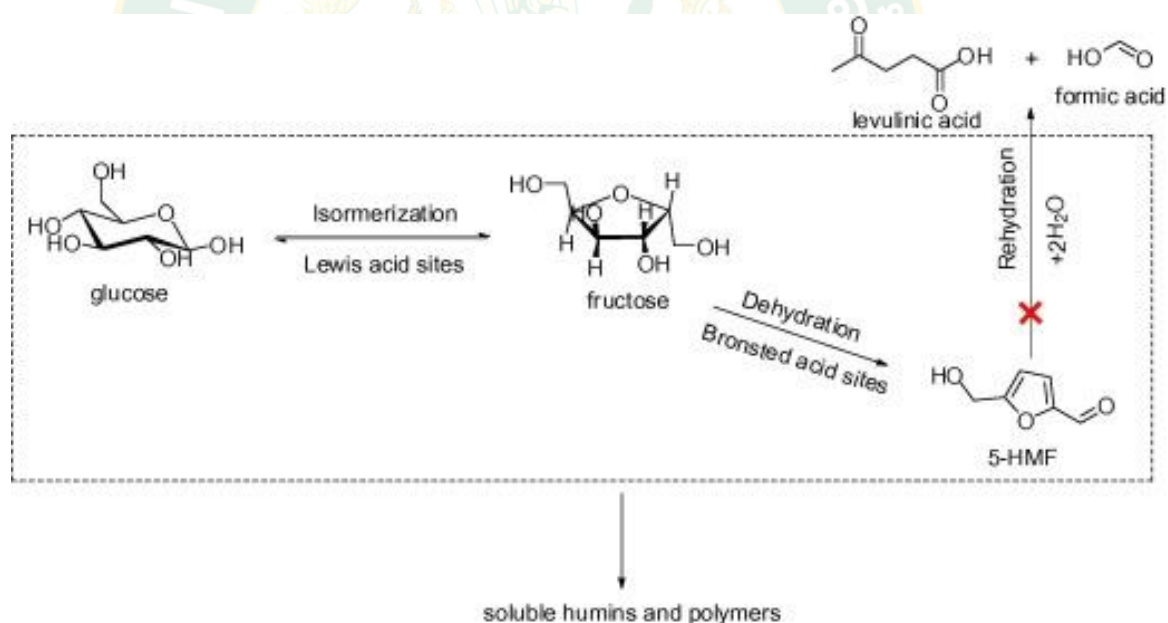

**Figure 1** Mechanism of HMF formation from glucose and fructose

#### 4) Diastase activity

Diastases ( $\alpha$ - and  $\beta$ -amylases) are enzymes naturally present in honey. Its depend on the floral and geographical origins of the honey. Its function is to digest the starch molecule in a mixture of maltose (disaccharide) and maltotriose (trisaccharide). They are sensitive to heat (thermolabile) and consequently are able

to indicate overheating of the product and the degree of preservation. Similar to 5-HMF, the diastatic activity can be used as an indicator of aging and increase temperature because the diastatic activity may be reduced during storage or when the product is subjected to heating above 60°C (Da Silva et al., 2016). Honey diastase activity (DN) is a quality factor, influenced by honey storage and heating and is thus an indicator of honey freshness and overheating. Although there is a large natural variation in diastase, the present standard of a minimum DN value of 8 has proven to be useful (Bogdanov et al., 1999).

#### 5) Enzymes in honey

Enzymes are another important constituent of honey because they play an important role in honey production from the nectar of the plant. Enzymes are the indicator of heat sensitive and extra low levels indicate that honey has been overheated. Moreover, their activities are decreased during storage and used as indicators of the freshness of honey (D'Arcy, 2007). Table 4 lists the enzymes in honey.

**Table 4** Enzymes in honey

Enzyme	Characteristics
<b>From worker honeybees</b>	
Invertase	- Hydrolyses (inverts) sucrose to glucose and fructose; more heat sensitive than amylase.
Glucose oxidase	- Oxidises glucose to gluconic acid and hydrogen peroxide in the presence of water.
<b>From plants (nectar/honey dew)</b>	
Catalase	- Regulates activity of glucose oxidase by controlling hydrogen peroxide equilibrium.
Acid phosphatase	- Occurs in pollen, and in nectar and honey, but very little in honey stored by honeybees fed sucrose.
$\alpha$ - and $\beta$ -Amylase (diastase)	- A small portion in some honey is from plants.

**Source:** adapted from D'Arcy (2007)



#### 6) pH and acidity of honey

Honey contains 0.17 - 1.17% organic acids and 0.05 - 0.15% amino acids. The organic acids reported to be present in honey are acetic, butyric, citric, formic, gluconic, lactic malic, pyroglutamic and succinic acid. The dominant organic acid is gluconic acid which forms by glucose oxidase acting on glucose. (White and Doner, 1980) reported the probability of the presence of glycolic,  $\alpha$ -ketoglutaric and pyruvic, tartaric and 2- or 3-phosphoglyceric acid,  $\alpha$ - or  $\beta$ -glycerophosphate and glucose-6-phosphate in honey. Further, a higher acidity level of honey is reported to increase the stability of honey against microbiological actions (D'Arcy, 2007).

Free acidity is an important parameter related to the deterioration of honey. It is characterized by the presence of organic acids in equilibrium with lactone, internal esters and some inorganic ions such as phosphates, sulfates and chlorides. The Codex Alimentarius Committee on Sugars (2001) permits a maximum value of 50.00 meq kg<sup>-1</sup> for free acidity. Higher values may be indicative of fermentation of sugars into organic acids (Da Silva et al., 2016).

Acidity is an important quality criteria. Honey fermentation causes an increase in acidity and because of this a maximum acidity value has proven useful, although there is a considerable natural variation. The old standard fixed a maximum of 40 meq kg<sup>-1</sup>, which has been increased to 50 meq kg<sup>-1</sup> in the Codex draft, as there are some honeys, which have a higher natural acidity (Bogdanov et al., 1999).

#### 2.1.2 Physical properties of honey

Honey is a viscous liquid mainly consisting of glucose and fructose. However, its physical properties are different from an invert sugar solution with the same moisture content. Thus, the physical characteristics of honey are largely determined by the types and concentrations of sugars and other compounds in honey.

##### 1) Viscosity of honey

The important property or parameter in the handling and processing of honey is viscosity. The flow properties depend on the composition, moisture content, and

temperature of honey. Normally, honey with a low viscosity is present from it has high moisture content, furthermore, the composition of individual sugars and the size and amount of the colloids in honey are influence with honey viscosity (Bhandari et al., 1999). Honey is newtonian fluid, also the viscosity is independent of the shear rate and previous shear history, depends only on composition and temperature (D'Arcy, 2007).

## 2) Colour

Colour is the first attractive attribute of honey, and as such is very important for commercialization. It is important parameter in the quality, acceptance and preference of consumers. The color of honey depends on the floral source and its mineral content. A dark color in honey may develop during storage temperature and the composition of the honey (Da Silva et al., 2016). Nevertheless, colour is an important characteristics of upon which honey is classified by honey producers, packers and end-users (Rahima, 2014).

Honey's colour is a temperature sensitive parameter, and honey can become darker as a result of different storage conditions. Honey's colour form a continuous range from very pale yellow through ambers to a darkish red amber to nearly black. The variations are almost entirely due to the plant source of the honey, although climate may modify the colour somewhat through the darkening action of heat (White and Doner, 1980). However, the colour of honey could be assessed by the method adopted by the Association of Official Analytical Chemists uses a Lovibond 2000 visual comparator (Subba Rao, 1990). Studied have also shown that honey colour can be assesses by the CIE-1931 or the more recent CIE-1976 ( $L^*a^*b^*$ ) or CIELAB methods (Rahima, 2014). According to CIE concepts, the human eye has three colour receptors; red, green and blue; and all colours are combinations of those. The amount of all needed to form any particular colour are called the tristimulus values and are denoted  $X$ ,  $Y$  and  $Z$ , respectively. It uses the chromaticity diagram to designate various colours as shown in Figure 2.

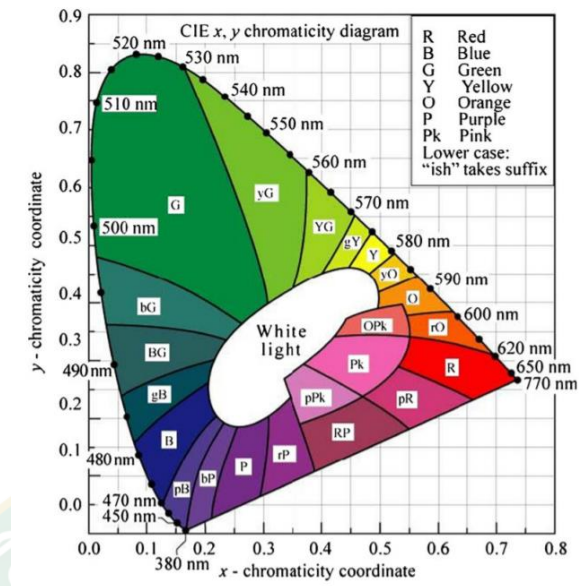

Figure 2 CIE chromaticity diagram

Source: Pathare et al. (2013)

Primary Y, known as luminous reflectance or transmittance, contains the entire lightness stimulus. The application of the weighting to a reflectance curve gives the tristimulus values, which are denoted by the capital letters X, Y and Z. The Hunter  $L^* a^* b^*$  developed in 1948 for photoelectric measurement and the CIE  $L^* a^* b^*$  colour space devised in 1976 provide more uniform colour differences in relation to human perception of differences as shown in Figure 3.

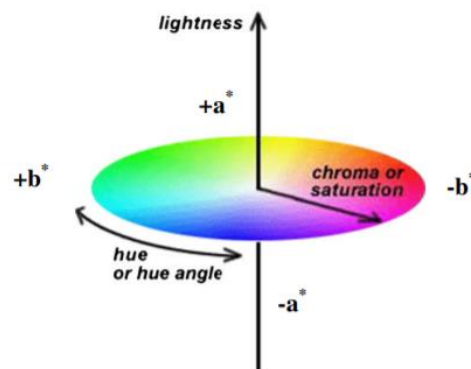

Figure 3 CIELAB colour space

Source: Pathare et al. (2013)

The parameter  $a^*$  takes positive values for reddish colours and negative values for the greenish ones, whereas  $b^*$  takes positive values for yellowish colours and negative values for the bluish ones.  $L^*$  is an approximate measurement of luminosity, which is the property according to which each colour can be considered as equivalent to member of the greyscale, between black and white. Chroma ( $C^*$ ), considered the quantitative attribute of colourfulness, is used to determine the degree of difference of a hue in comparison to a grey colour with the same lightness. The higher the chroma values, the higher is the colour intensity of samples perceived by humans. Chroma was calculated using Eq. (1).

$$C^* = \sqrt{a^{*2} + b^{*2}} \quad \text{Eq. (1)}$$

Hue angle ( $h^0$ ), considered the qualitative attribute of colour, is the attribute according to which colours have been traditionally defined as reddish, greenish, etc., and it is used to define the difference of a certain colour with reference to grey colour with the same lightness. This attribute is related to the difference in absorbance at different wavelengths. A higher hue angle represents a lesser yellow character in the assays as shown in Eq. (2) – Eq. (4) (Briones and Aguilera, 2005; Costa et al., 2015).

$$h^0 = \tan^{-1} \left[ \frac{b^*}{a^*} \right] \quad a^* > 0 \text{ and } b^* > 0 \quad \text{Eq. (2)}$$

$$h^0 = \tan^{-1} \left[ \frac{b^*}{a^*} \right] + 180 \quad a^* < 0 \quad \text{Eq. (3)}$$

$$h^0 = \tan^{-1} \left[ \frac{b^*}{a^*} \right] + 360 \quad a^* > 0 \text{ and } b^* < 0 \quad \text{Eq. (4)}$$

The meaning of  $h^0$  values were including;

0 - 45° = purple-red to orange-red	180 - 225° = green to green-blue
45 - 90° = orange-red to yellow	225 - 270° = dark blue-green to dark blue
90 - 135° = yellow to green	270 - 315° = dark blue to purple
135 - 180° = yellow-green to green	315 - 360° = purple to purple-red

Whiteness index ( $WI$ ) are widely measured to yield numbers correlating closely with consumers' preferences for white colours. It mathematically combines lightness and yellow-blue into a single term.  $WI$  indicates the degree of whiteness as shown in Eq. (5).

$$WI = \sqrt{(100 - L^{*2}) + a^{*2} + b^{*2}} \quad \text{Eq. (5)}$$

### 3) Specific heat of honey

Specific heat is determined as a heat related property of honey, and has received very little attention in the past. Helvey (1954) reported that the specific heat of honey containing 17.4% moisture content is 0.54 at 20°C but that is varies depending on the moisture content (Table 6). He also presented the results obtained by MacNaughton for a temperature range of 29°C to 48°C, where the specific heat ranged between 0.56 – 0.73.

**Table 5** Specific heat of honey

Moisture content (%)	Specific heat
20.4	0.60
19.8	0.62
18.8	0.64
17.6	0.62
15.8	0.60
14.5	0.56
Coarsely granulated	0.64
Finely granulated	0.73

**Source:** adapted from D'Arcy (2007)

## 2.2 Crystallization of Honey

Honey is a supersaturated solution of glucose and it has a tendency to crystallize spontaneously at room temperature in the form of glucose monohydrate

(Ajlouni and Sujirapinyokul, 2010; Saxena et al., 2014; Tosi et al., 2004). Some honey varieties, such as Sunflower and Lychee flower honey tend to rapidly crystallize during storage and on the market shelves. The crystallization of honey was impact with market value reduction, and it became largely unacceptable to Thai consumers. Because the principle of honey crystallization is not widely known to the consumers, crystallized honey is often perceived to be an adulterated product. The consumers generally anticipate that crystallized honey is artificially produced or contains sucrose which beekeepers use to feed the bees during the non-flowering season (Srinual and Intipunya, 2009).

Almost all honeys are in liquid form as stored by the bees in the comb, but after it extracted from the comb, it crystallized within a few days or weeks (Conforti et al., 2006). Regarding honey is a supersaturated solution of glucose and it has a tendency to crystallize spontaneously at room temperature in the form of glucose monohydrate. Crystallization of honey, also called granulation, is an undesirable process in liquid honey because it affects the textural properties, making it less appealing to the consumer, who prefers it liquid and/or transparent (Ajlouni and Sujirapinyokul, 2010; Saxena et al., 2014; Tosi et al., 2004).

### **2.2.1 Crystallization mechanism**

Crystallization is the formation of highly organized solid particles within a homogeneous phase. Crystals can be grown from the liquid phase, either within a solution, melt or from the vapour phase. Liquid solution which is saturated with a solute can be macroscopically considered to be in a thermodynamic equilibrium. However, when the state of the system shifts to non-equilibrium, where the concentration of the solute in the solution exceeds its saturated (or equilibrium) concentration, crystallization will occur. They called this situation is “supersaturated”. Key concepts in crystallization are summarized in Figure 4 (Deora et al., 2013).

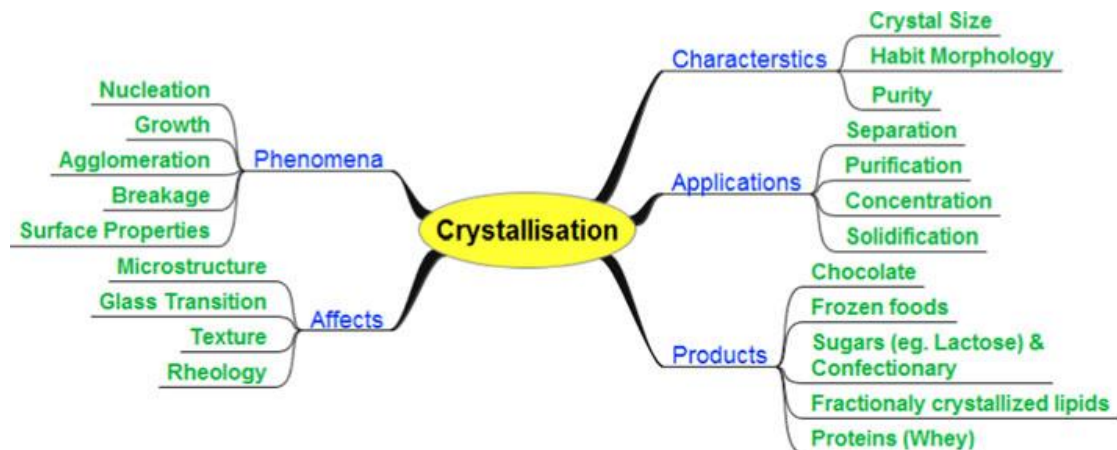

Figure 4 Key concepts in crystallization

Source : Deora et al. (2013)

Crystallization of honey is a matter of interest for many beekeepers and processors. The reason is that each variety of honey crystallizes differently. Some of them never crystallizes, some crystallize very slowly, some very quickly, some have fine crystals, and some have bigger crystal grains. Crystallization of honey affects the keeping quality (yeast growth) as the non-crystallized portion will contain a greater amount of water which results from the rejected water from crystals. Consequently, the top liquid layer in a container of a crystallized honey will contain more water than the bottom crystallized portion. This makes the top liquid layer vulnerable to yeast growth (Bhandari et al., 1999).

Table 6 Characters associated with crystal shape of industrial importance

Crystal shape	Associated character/behavior
Long, needle-like	- Easily broken during centrifugation and drying
Flat, plate-like	- Difficult to wash during filtration or centrifugation and results in relatively low filtration rates
Complex or twinned crystals	- More easily broken in transport than compact crystal habits
Rounded or spherical crystals	- Tend to give considerably less difficulty with caking than do cubical or other compact shapes.

Source: adapted from Deora et al. (2013)

A substance capable of forming more than one different crystal is said to exhibit polymorphism, and the different forms are called polymorphs. The shape or morphology of the crystals is paramount to industrial operations (Table 6).

Temperature and viscosity of honey influence the crystallization rate by viscosity is a function of temperature. In several published reports found that the crystallization rate for honey is maximum at around 10 - 15°C while the rate if decreased above and below this temperature. Thus, honey crystallization will not occur at above 30°C due to the increased solubility of glucose. The crystallization rate is increased below room temperature due to increased supersaturation effects. At about 10 - 15°C, the effect of supersaturation is more dominating than the viscosity effect or the viscosity of honey is least effected above this temperature range. Moreover, the crystallization phenomenon is viscosity limited at below this optimum temperature (Bhandari et al., 1999; White and Doner, 1980). The crystallization will be completely seized below glass transition temperature when the molecular mobility is almost null. The hypothesis is explained in Figure 5 and crystallization behavior has similar type with various polymers.

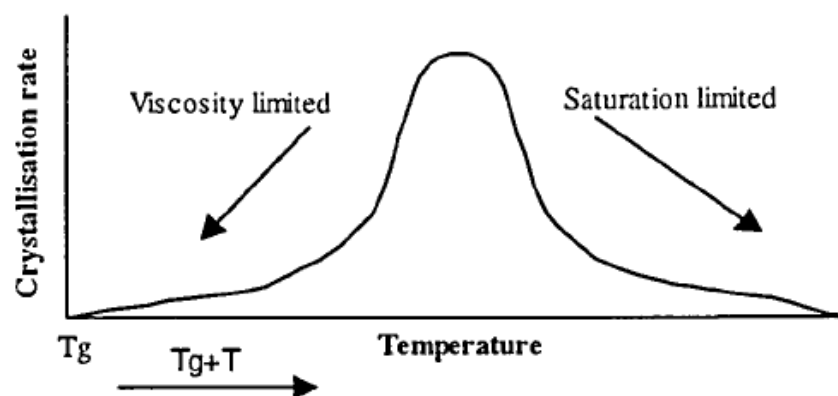

**Figure 5** Hypothetical crystallization rate of honey with respect to the temperature ( $T_g$  is glass transition temperature, and  $T$  is temperature of honey at any instance)

**Source :** Bhandari et al. (1999)



### 2.2.2 Factors affecting with crystallization of honey

The honey crystallization is a natural process, which is depending on the sugar content, the temperature, the water content and the storage time.

1) Sugar content: the higher the glucose content, the faster the crystallization. If honeys present more than 28% glucose, it will occur rapidly crystallization. While those with less than 28% glucose, it will remain in liquid form in longer period.

2) Temperature: temperature which is between 10 - 18°C, is the optimal temperature for honey crystallization. Crystallization is slowed down at lower temperature or cooled condition but in the deep-freezer honey remains liquid for longer time. Moreover, the crystallization will be slowed down at higher temperature also (more than 25°C) and will get a rough crystalline texture.

3) Water content: honeys with a water content between 15 – 18%, it is suitable for crystallization of honey. If the water content is more and less from that range, the crystallization will be slowed down. Best spreadability have crystallized honeys with water content between 17 – 18%. If the water content is more than 18%, will get a rough crystalline texture, but honeys with lower water content will have harder crystallization texture (Bogdanov, 2011).

Crystallization in honey is a complex phenomenon and problematic for many industrial processes as it causes difficulty in handling and processing in machinery due to the “stickiness” and higher viscosity (Conforti et al., 2006; Deora et al., 2013; Quintero-Lira et al., 2016). The mechanism of crystallization is a natural phenomenon in honey, which is a supersaturated sugar solution. The supersaturated state occurs because honey contains more than 70% sugars and less than 20% water (D'Arcy, 2007). When crystallization occurs during storage in an undesired and uncontrolled fashion, it causes the product to be cloudy and less appealing to the consumer. In addition, end consumers also prefer liquid honey for consumption. A common approach for dissolving the crystals (referred to as liquefaction) and retarding crystallization during handling is to heat the honey to sufficiently higher temperatures (Conforti et al., 2006; Subramanian et al., 2007).

Moreover, the crystallization of honey usually results in increased moisture of the liquid phase, which makes the honey vulnerable to yeast growth that may cause fermentation of the product and, within time, produces subsequent organoleptic modifications and degrades the quality (Kabbani D. et al., 2011).

The major problem resulting from glucose granulation is that the resulting increased moisture content of the liquid phase allows yeast cells, which occur naturally in honey, to multiply and fermentation to proceed. It is well known that properly ripened honey is not susceptible to spoilage by microorganisms, with the exception of osmophilic yeasts, and then only at moisture levels above 17%. Considerable effort has been directed toward preventing granulation in honey which is to be sold in the liquid form and in controlling granulation in honey which is to be sold in finely granulated form (Doner, 1977).

### **2.2.3 Related literature reviews of crystallization in honey:**

Shinn and Wang (1990) determined the effects of various chemical and processing factors on the textural properties of crystallized honey using response surface methodology and established mathematical model equations for the prediction of the behavior of crystallized honey. The result shown that there were two chemical factors (glucose/maltose fraction and moisture content) and two processing factors (seed addition and holding time) were found to affect the final texture of the crystallized honey. The glucose/maltose fraction was used as a primary indicator for selecting suitable honey for processing, because moisture was easy to adjust. Mathematical model was used to estimate maximum textural responses from optimum chemical composition and processing conditions.

Bhandari et al. (1999) reviewed the paper and presented that the current method for predicting honey crystallization was not suitable and most of all were based on the composition considering honey as a glucose-fructose-water system. They put forward a hypothesis based on viscosity and glass transition temperature.

Bhandari and Bareyre (2003) estimated the crystalline phase present in the glucose crystal-solution mixture by water activity measurement. The result shown that the water activity has a strong linear correlation ( $R^2 = 0.994$ ) with the amount of

glucose present above saturation. The re-dissolving the crystalline fraction was calculated from the amount of crystalline phase present or  $\Delta G$  in the mixture and expressed in the equation of  $\Delta G = 846.97(a_{w1} - a_{w2})$ . Thus, this method is proved to be suitable for glucose and can be applied to other systems such as sucrose and lactose. Besides the linear model for prediction of water activity of supersaturated glucose, Raoult's, Norrish and Money-Born equations were also tested.

Mora-Escobedo et al. (2006) investigated in an attempt to determine specific precautions that could be taken to delay crystallization in Tajonal honey by determining of physicochemical, thermal, rheological and crystallization characteristics in different moisture contents (16.2 to 20.6%) honeys. The result shown that the moisture content and the glucose/water ratio were useful indexes for crystal growth in honey. But the thermal measurements were not adequate to describe the crystallization of the samples. Another solution is to influence the crystallization phenomenon in order to obtain crystallized products with acceptable sensory characteristics.

Dettoni et al. (2018) was described the kinetic of crystallization of three honey samples which were represent in fast, medium and slow crystallization honey. The evolution of physical properties such as water activity, color and texture was analyzed during crystallization kinetic. They found that Avrami equation was well describe the crystallization kinetic, although the relation of the Avrami parameters with the nucleation and crystal growth is not entirely clear. The Avrami index which is a parameter of nucleation characteristics and growth mechanisms of the crystals. The kinetic of honey crystallization were considered the increase of the relative crystallized fraction (X) during storage. Thus, this model may applied for evaluate the crystallization kinetic of honey cream product on the basis of fructose/glucose fraction ratio.

### 2.3 Control of crystallization

Honey is a supersaturated sugar solution consisting of mainly glucose and fructose. The excess glucose precipitates in the form of crystalline D-glucose monohydrate and releases water during extraction and storing. Crystallization

(granulation) is an undesirable process in liquid honey and must be prevented or delayed as much as possible. It causes the product to become cloudy and less appealing to the consumer (Assil et al., 1991). The crystallization rate depends on the origin of honey and the method of processing. Natural crystallization, before heating, usually produces fine grained crystals because of the presence of fine seed crystals and initiators such as dust, pollen, and fine bubbles. These seed crystals or other small particles are not present in heated or filtered honey, since filtering removes the potential crystallization nuclei and heating dissolves small crystals. However, crystallization is a natural phenomenon in most honeys and takes place at some time during storage. Honeys with less than 30% glucose such as longan and wild honeys never or hard to crystallize. Further, some honeys crystallized rapidly such as sunflower and lychee honeys. Most honeys are supersaturated with respect to glucose, with the potential to cause glucose to crystallize spontaneously at room temperature in the form of glucose monohydrate.

There are several artificial methods studied and proposed to stop honey crystallization such as storing at freezing temperature ( $-40^{\circ}\text{C}$ ), heat treatment to dissolve crystals and crystal nuclei, removal of air bubbles, dust and pollen particles by filtration, filling at higher temperatures ( $>45^{\circ}\text{C}$ ) to avoid air bubbles incorporation during filling, addition of inhibitors such as isobutyric acid and sorbic acid, adjusting the glucose to fructose ratios or the water content. However, use of additives are not permitted in various countries (including Australia), so heating or blending of various honeys with known composition or changed the appearance into creamed honey are some of the common ways to control the crystallization (Bhandari et al., 1999).

Meanwhile, this property may be desirable for a particular purpose, such as creamed honey production. However, it is not easy to control the process, especially it is too often that the creamed honey is too hard, with consistency more like a brick than a nice spread is as unacceptable as honey that is too soft. Moreover, different honey type will present different honey properties likely in Thai honey. Therefore, the “proper” method of production would be came from the control of process for obtaining the good texture.

### 2.3.1 Factors affecting control of crystallization

There are a number of different factors that influence crystallization, or the prevention of crystallization, in food products. Processing conditions must be chosen for the desired effect, to either promote or prevent crystallization. These conditions depend on the interactions of ingredients, so formulation plays an important role in the selection of the optimal processing conditions. The product has been made and packaged, any changes during distribution and storage influence shelf life. Proper storage conditions are necessary to maintain the desired state of the product and allow the longest possible shelf life.

#### 1) Heat and mass transfer rates

During processing, the rates of heat and mass transfer are important and to defining proper control of crystallization. The rates of heating and cooling during the process can impact crystallization as can the hold times and temperatures. Moreover, agitation energy, whether intentional through forced mixing or unintentional through fluid shear forces, can promote crystallization.

- Rate of cooling: The rate of cooling of a mass to a desired crystallization temperature, as in production of fondant or crystallization of grained caramel and fudge, determines the extent and type of nucleation. If the mass is cooled uniformly and rapidly to the desired processing temperature, all of the mass will crystallize at the same condition and at the same time. This leads to the maximum production of nuclei and the narrowest distribution of crystal sizes. On the other hand, if cooling is slow or nonuniform, crystallization will also be nonuniform. In regions that cool more rapidly, nucleation will take place first and these crystals will continue to grow as the rest of the mass crystallizes. The nuclei that formed first become larger than the other crystals and this may result in a coarse texture. Therefore, it is important to ensure that processes are designed so that the entire mass cools rapidly and uniformly to the desired crystallization temperature. The nature of the crystalline mass that formed between the primary crystals (during agitation) was significantly different for the different cooling rates. These different crystalline microstructures resulted in significantly different mechanical properties, which lead to different textures. Clearly, the conditions under which these samples crystallized can have a

large effect on the texture and quality of these products. Rate of cooling also is important in systems where crystallization is undesired. For amorphous products, cooling must be sufficiently rapid that the mass passes through the crystallization zone between the solubility curve and glass transition zone before nucleation occurs. In this case, heat transfer must occur more rapidly than the time scale for onset of nucleation (induction time) in the product. Cooling must be sufficiently rapid so that the mass quickly reaches a point where induction times for nucleation are very long. The temperature at this point depends on formulation and other processing requirements.

- Crystallization temperature: The temperature at which crystallization occurs is also important to control of the desired crystal size distribution and product texture. The optimum nucleation point is based on the balance between thermodynamic driving force (supersaturation) and mobility effects (glass transition). At the optimal temperature, the maximum number of crystals will be formed, resulting in formation of a narrow distribution with small mean size. This is generally the desired characteristic for products with smooth texture (caramels, ice cream, frozen foods, etc.).

- Agitation: In products where massive nucleation is desired, it is important to provide sufficient agitation to promote maximum nucleation. Mechanical energy input enhances the nucleation process. During processing of fondant, for example, the sugar mass is cooled to the desired crystallization temperature and then worked extensively in a beater to promote massive crystallization. This results in the production of many small crystals and produces a smooth texture.

Intensity of agitation, or the relation between micro- and macromixing, is also important in producing a crystal-size distribution suitable for efficient separation. This principle is widely recognized in many industries although it also applies in certain food processes.

## 2) Post-processing effects

Even though a product has been manufactured and packaged, it does not mean that no further changes in crystalline structure will occur. In products where crystals have been formed during processing, it is still possible, if not likely, that

further changes in the crystalline structure occur during storage. It is widely recognized in some products that full crystallization is not completed for a period of time after packaging, perhaps even up to several weeks. The texture of some confectionery products, for example, is different at the point of packaging as compared to the texture of products sold to the consumer. These changes may come about several reasons.

It is possible that the maximum phase volume of crystalline material, or full de-supersaturation of the solution, may not be attained prior to packaging. The balance between time of processing and completion of crystallization must be weighed carefully in determining process conditions. Typically, high throughput rates result in products that are not fully crystallized during processing unless crystallization kinetics are also rapid. However, as long as crystallization continues under reasonably controlled conditions after packaging, product quality will not suffer greatly.

One product where crystalline change take place after processing is butter. When butter comes off the processing line, it is still sufficiently fluid or pliable that it can be formed into the desired shape. After packaging, the butter is cooled to refrigeration temperature where further crystallization takes places. Lowering the temperature causes mor of the butter to crystallize, which results in a significant hardening of the butter and gives the product some of its desired attributes. In general, any changes in crystal size distribution during packaging and storage must be taken into account in terms of overall product quality (Myerson, 2002).

## **2.4 Creamed honey**

### **2.4.1 Creamed honey production**

Creamed honey is finely crystallized honey and it is the product of the deliberate, controlled crystallization of honey. It is a product which produced by controlled crystallization. It is a very fine grain semisolid product and present a texture like a three-dimensional interlaced network of crystals in liquid phase. The texture of honey cream depends on the moisture content, glucose content and the

quality of seed material. Dyce (1931a,b) developed the process for producing honey cream or creamed honey as following below flow chart (Figure 6).

The smoothest texture of creamed honey was achieved by ensuring a large number of very fine crystals and fragments are present in the seed material (D'Arcy, 2007; White and Doner, 1980).

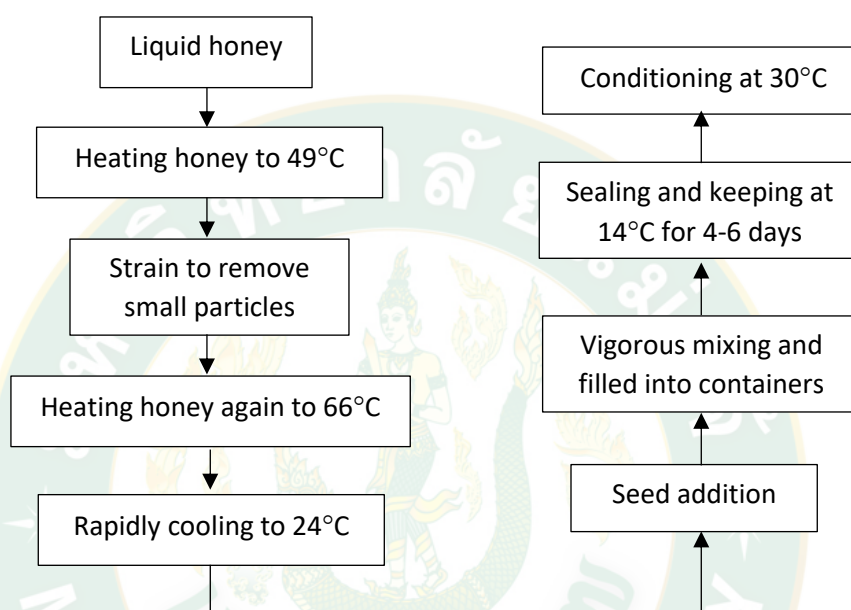

**Figure 6** The procedure of honey cream production by Dyce method (1931)

**Source:** adapted from D'Arcy (2007) and Dyce (1931a, b)

Normally, the conventional method usually damages the transparency of such honey due to brown turbidity, and also results in alterations in undesired flavor and detriment of phytochemical compounds and antioxidant properties (Chaikham and Prangthip, 2015; Fauzi et al., 2014). Alternate technologies such as ultrasonic (US) treatment was interested method which can used in heat treatment at low temperature of creamed honey production for dissolve some crystals and it has the potential to control the crystallization process of creamed honey production. However, the effects of ultrasound treatment should be determined, it is necessary to be able to produce high creamed honey quality in laboratory by using reference method of the Dyce method (D'Arcy, 2007; Dyce, 1931a, b).





**Figure 7** Creamed honey

**Source:** Food Engineering laboratory (2018)

Moreover, to obtain good spread behavior from creamed honey, it is desired to seed the liquid honey with fine glucose monohydrate crystals. The rate crystallization should be controlled at a rate that is not too slow to avoid large gritty crystals formed in the final product and not too fast to prevent the dissolution of crystals in the honey. To produce fine crystals in the final product, it is also better to stirred honey to promote crystallization (Dyce, 1931a).

#### **2.4.2 Factor affecting crystallization control in creamed honey**

The important factors in the creamed honey production were found to be using suitable amount of seed honey as starter, conducting the crystallization at the optimum temperature and stirring the seed into the liquid sufficiently to ensure the even distribution of many fine crystals. Moreover, other factors impacting with creamed honey texture was including;

##### 1) Floral source

Since composition of honey varies with the floral sources, specific gravities of honey will also vary slightly, this has a significant effect on the crystallization control of creamed honey. Therefore, different floral sources of honey will result in different characteristics of honey in terms of flavor and color (Bhandari et al., 1999).

##### 2) Seeding

The suitable quantity of seed or starter which was found in the experimental of Dyce process (Dyce, 1931a,b) was approximately 5% of the mass of honey to be

seeded. If nuclei are abundant, there will be higher surface area which results in less deposited material per crystal which renders small crystals in the product (Dyce, 1931a). Moreover, it is desired to use fine granulated honey for seeding during the crystallization process, in order to obtain a spreadable creamed honey for the market.

### 3) Storage temperature

Regarding to the properties of honey are temperature-sensitive, great fluctuations in temperature was directly affect the viscosity, moisture content and crystallization rate in creamed honey products. It changes the texture and taste during the storage time although the desired palatable and marketable properties are achieved during the manufacture phase. National Honey Board (1997) specified the optimum storage temperature of honey should below 11°C or between 21 to 27°C in air-tight containers.

### 4) Crystallization temperature

Temperature control is important in crystallization. At a temperature of about 14°C, honey crystallizes at the fastest rate, although (Dyce, 1931a) claims that fluctuating temperature will definitely accelerate the honey granulation. At 15°C, low moisture content honey will be crystallized faster than those which higher moisture content. It meant that higher moisture content honey will granulate faster at a temperature below 15°C. Moreover, if temperature changes cause changing in viscosity of honey. Crystal growth is favored at reduced temperature because the supersaturation of dextrose in honey is increased. However, viscosity will increase in low temperature and reduce diffusion of dextrose, it will retard crystal growth. Using these phenomena, honey should be cooled to room temperature as rapidly as possible once crystallization of dextrose monohydrate crystals had reached the desired size that result in palatable honey cream.

**Table 7** Reviews of seed addition

No.	Reviews	Honey types	%Seed addition	Storage condition	Texture of final product
1	The Dye process  E.J. Dyce (1931)	-	5 – 10% of cream as seed starter	14°C for 4 – 6 days and Conditioning at 30°C	Smooth and creamy texture
2	Production of Sugar Crystals from Sunflower Honey  Philailuk and Methanee (2012)	Sunflower honey	Glucose powder: 1:1.1, 1:1.2 and 1:1.3	10 and 25°C	Store at 10°C was the most suitable method for crystallization of sunflower honey
3	Producing Clover and Cotton Creamed Honey under Cooling Conditions and Potential use as Feeding to Honey Bee Colonies  Elhamid and Abou-Shaara (2016)	Clover and cotton honey	Glucose powder: 0.1%, 0.3%, 0.6%, 1.2%, 1.4%, 1.6% and 2.4%	5°C	Creamed honey can be obtained using glucose powder with 1.2, 1.8 or 2.4% (w/w) and storage temperature of 5°C

**Table 8** Reviews of storage temperature in honey

No.	Reviews	Honey types	Storage condition	Effect parameter	Conclude
1	DSC study of honey granulation stored at various temperatures	Polyfloral honey of the SE region of the province of Argentina	4, 10, 20 and -20°C	<ul style="list-style-type: none"> <li>- Crystal observation</li> <li>- the enthalpy of melting from DSC</li> <li>- Absorbance</li> </ul>	<ul style="list-style-type: none"> <li>- DSC appear to be an appropriate tool to analyse the granulation of honey</li> <li>- <math>T_m</math> of 25 - 45°C = fine grained honey</li> <li>- <math>T_m</math> of 45 - 65°C = coarse-grained honey</li> </ul>
2	Lupano (1997) Crystallization of Honey at 20°C	Different regions of the province of Buenos Aires	-20°C	<ul style="list-style-type: none"> <li>- Physicochemical properties</li> <li>- Crystals observation</li> <li>- Firmness and Adhesivity</li> <li>- Viscosity</li> </ul>	The parameters that affect honey crystallization at room temperature have a different effect at freezing temperature
3	Comforti et al. (2006) Influence of temperature and homogenization on honey crystallization	Honey from Campos Gerais	15 and 25°C	<ul style="list-style-type: none"> <li>- Physicochemical properties</li> <li>- 5-HMF and diastase activity</li> <li>- absorbance</li> </ul>	Stored at 15°C was uniform and fully crystallization but less than half the volumes was crystallized at stored of 25°C
	Costa et al. (2015)				

**Table 9** Reviews of storage temperature in honey (Continue)

No.	Reviews	Honey types	Storage condition	Effect parameter	Conclude
4	Effect of freezing and room temperature storage for 18 months on quality of raw rapeseed honey ( <i>Brassica napus</i> )	raw rapeseed honey ( <i>Brassica napus</i> )	20 and - 20°C	- Physicochemical properties - 5-HMF and diastase activity - Viscosity	Store at 20°C was different colour to a greater extent than freezing, and significantly increased of HMF content and decreased of diastase activity
	Kędzierska-Matysek et al. (2016)				
5	Effects of storage temperature on HMF and diastase activity of strained honeys	Strained flower honey and honeydew honey (Turkey)	10 ± 2°C 22 ± 2°C 35 ± 2°C For 3 months	- Physicochemical properties - 5-HMF and diastase activity - electrical conductivity	HMF values did not exceed 40mg/kg at storage temperature of 10 ± 2°C and 22 ± 2°C
	Korkmaz and KÜPLÜLÜ (2017)				

## 2.5 Processing techniques involving with creamed honey

Honey processing includes all the handling of honey during which its physical and chemical properties. They are changed in order to facilitate handling or to improve certain qualities and present in following step including:

- 1) Clearing honeybees from the honey supers or framed combs to be harvested and taking the combs to the honey house.
- 2) Warming the combs to 32 - 35°C.
- 3) Uncapping the combs and dealing with the cappings.
- 4) Extracting the honey from the combs in a centrifuge.
- 5) Clarifying the honey by passing it through a strainer and/or baffle tank.
- 6) In large processing plants, flash-heating and pressure-filtering.
- 7) Storing the honey in bulk containers.

At lower temperatures, the flow rate of honey is very slow. But at higher temperatures, the quality of honey may be damaged. Therefore, the honey temperature will be held at below 55°C for all processing operations including flow through pipes, pumps and strainers (D'Arcy, 2007). Honey extracted from combs and apiaries contains pollens, beeswax, and other undesirable materials, besides yeast, that are to be removed for better product quality and shelf life. Therefore, honey is processed before packing in bottles or other containers. Two important stages of honey processing are filtration and heating. Pollens or bee wax or other materials separation are normally done through straining and pressure filtration. Heat or thermal processing of honey eliminates the microorganisms responsible for spoilage and reduces the moisture content to a level that retards the fermentation process (Subramanian et al., 2007).

### 2.5.1 Dehydration techniques in honey

The moisture content plays an important role in the stability of honey in relation to fermentation and granulation during storage. (White Jr, 1975) reported that honeys with moisture content below 17.1% will not ferment. The tendency of honey to crystallize depends on its composition and moisture content. Normally, honey

with glucose content less than 30% rarely crystallization and those with 35% glucose are naturally crystallization (D'Arcy, 2007). Moreover, Doner (1977) quoted that honey with glucose/water ratios less than 1.7 are related to non-granulating honey while honeys with ratios greater than 2.1 are rapidly granulating. There were two ways to increase the glucose/water ratio, first is to reduce the water content and second is to increase the glucose content.

Heat processing of honey of honey will eliminates the microorganisms responsible for spoilage and reduces the moisture content to a level that retards the fermentation process. But honey will burn or occur in maillard reaction if we try to dehydrate it at too high temperature. Thus, infrared heating are gaining popularity over conventional heating owing to their inherent advantage of rapidity (Hebbar et al., 2003).

Infrared heating of food is also gaining popularity because of the simplicity of construction and operation, its transient response, significant energy savings over thermal processes and ease of construction of hybrid systems with convective and conductive heating sources (Sandu, 1986). Infrared drying offers solution to problems that seemed to be unsolvable in the past and had many advantages as follows:

- 1) Uniform heating of the product
- 2) Leveling of the moisture profiles in the product and low product deteriorations.
- 3) Ease of control
- 4) Low-cost technology
- 5) Reduction in drying time

### **2.5.2 Heat processing techniques in honey**

Regarding the majority of liquefaction and prolongation of the honey crystallization is carried out by heating methods in industry, so the recommended pasteurization method was interesting step. Pasteurization delays crystallization by dissolving crystals in the honey by heat treatment and it also kills yeast cells, which in turn prevents the possibility of fermentation. The main limitation of heating is however, the possibility of quality deterioration.

Due to the limitations of heat treatment, alternate technologies to innovate in the beekeeping sector in terms of processing techniques have been studied in the past. The most important technologies are as following.

1) Irradiation: Food is submitted to gamma irradiation process for different purposes, one benefit is to reduce microorganism's load.

2) Microwave and infrared heat: Infrared (IR) heating can be applied to various food processing operations, namely, drying, baking, roasting, blanching, pasteurization, and sterilization. Combination of IR heating with microwave heating and other common conductive and convective modes of heating have been gaining momentum because of increased energy throughput.

3) Ultrasonic treatment or sonication is a processing alternative for many liquid food products. Its mechanical power is being used for a gentle yet effective microbial inactivation and particle size reduction. When honey is exposed to ultrasonic treatment, most of the yeast cells are destroyed. However, yeast cells that survive sonication generally lose their ability to grow and reduced the rate of honey fermentation. Ultrasonic treatment did also eliminating existing crystals and inhibit further crystallization in honey (Rahima, 2014).

### **2.5.3 Heat treatment during honey processing**

The major problem with honey processors in tropical countries is its rapid deterioration in quality due to fermentation. Honey generally contains osmophilic (sugar-tolerant) yeast in greater or lesser amount and ferment, if the moisture content is high enough and storage temperature is favorable. The unprocessed honey tends to ferment within a few days of storage at ambient temperature because of its high moisture content and yeast count. One way to prevent fermentation is heating process with honey before storage (Subramanian et al., 2007).

Heating at higher temperature of for a longer period of time will cause honey damage, decrease of aroma and in extreme cases building of a caramel like taste. Overheating is determined most easily by the measurement of hydroxymethyl furfural and honey enzyme activity. Honey should be heated with care to prevent overheating (Bogdanov, 2008). In some cases, the honey is subjected to heat



treatment to inhibit or retard the crystallization process, or to block the development and growth of micro-organisms, such as preventing the contamination of the fresh product and also during filling or extraction, because honey must have an adequate fluidity (Da Silva et al., 2016).

Thermal processing is a common procedure to avoid microbial contamination and for promoting the formation of liquid honey by dissolution of crystals, which is preferred by both consumers and food industry, mainly due to easy handling (Kabbani D. et al., 2011). However, during thermal treatment, an important number of detrimental reactions (e.g. browning and changes in colour, cloud loss, off-flavours, texture, appearance) with important quality loss and production of food contaminants, e.g. 5-hydroxymethylfurfural, can occur.

In honey processing, heating condition is an important operation which should concern and control for quality controlling. Heating has been shown to have an effect on honey quality parameters such as HMF, diastase activity, invertase activity and colour. It can be recognized by an increase in HMF content because HMF is a product produced by the breakdown of sugars, especially in glucose and fructose. Normally, very small amounts of HMF are contained in fresh honeys and rarely exceed 10 mg/kg (D'Arcy, 2007).

## **2.6 Ultrasonic treatment in food processing**

Ultrasonic (US) is acoustic (sound) energy in the form of waves having a frequency above the human hearing range. The highest frequency that the human ear can detect is approximately 20.000 Hz. This is where the sonic range ends, and where the ultrasonic range begins. These waves are transmitted through a medium (water) without being weakened in power. They cause mechanical and thermal changes in the material through which they pass, and cause changes in unicellular organisms in addition to other effects. Over five years, ultrasonic treatment became an efficient tool for large-scale commercial applications, such as emulsification, homogenization, extraction, crystallization, low temperature pasteurization, activation and inactivation of enzymes, viscosity alteration and particle-size reduction (Rahima, 2014).

The fundamental effect of ultrasonic on a continuum fluid is to impose an acoustic pressure ( $P$ ) in addition to the hydrostatic pressure already acting on the medium. Process of compression and rarefaction of the medium particles and the consequent collapse of the bubbles comprises the well-known phenomenon of cavitation, the most important effect in high power ultrasonic. The combination of factors between heat, pressure and turbulence is used to accelerate mass transfer in chemical reactions, create new reaction pathways, break down and dislodge particles (when cavitation in proximity of a solid surface) or even generate different products from those obtained under conventional conditions. Ultrasonic cavitation is a physical phenomenon whose performance depends upon the parameters as following.

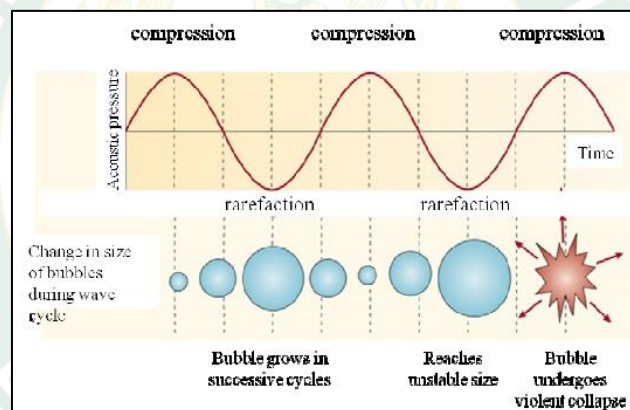

**Figure 8** Cavitation phenomenon

Source: Rahima (2014)

1) Frequency, at high sonic frequencies, on the order of the MHz, the production of cavitation bubbles becomes more difficult than at low sonic frequencies, of the order of the kHz. To achieve cavitation, as the sonic frequency increases, so the intensity of the applied sound must be increased, to ensure that the cohesive forces of the liquid media are overcome, and voids are created. The physical explanation for this lies in the fact that, at very high frequencies, the ultrasonic waves would occur the cycle of compression and decompression.

2) Intensity, the intensity of ultrasonic is the proportional to the amplitude of vibration of the ultrasonic source and an increment in the amplitude of vibration will lead to an increase in the intensity of vibration and to increase in the sonochemical effects.

3) Solvent, most applications are performed in water. However, both solvent viscosity and surface tension are expected to inhibit cavitation.

4) Solvent temperature plays roles in ultrasonic treatment. Faster diffusion rates occur at higher temperature but cavitation is better attained at lower temperature when the ultrasonic power of the generator is constant (Rahima, 2014).

### **2.6.1 Ultrasonic application with crystallization process**

Crystallization influences product quality for food processes including the freeze-concentration of fruit juices, freezing of ice-cream and other foods, freeze-drying, production of edible salt, granulated sugar and chocolates. Obtaining a desired uniform crystal size distribution is a challenge due to the inherently variable nucleation and crystal growth phases. Therefore, a method to control the nucleation phenomena and turn its stochastic behavior into a repeatable and predictable manner should be valuable for the food industry (Deora et al., 2013).

Ultrasonic application in food industry is used for different purposes as processing, preservation and extraction. The benefit of ultrasonic treatment in foods such as

- Food preservation
- Improvement of mass transfer
- Manipulation of food analysis and food texture
- Using short time and improvement of organoleptic quality of foods
- Reduce physical and chemical hazards
- Give better yield, selectivity and productivity
- Environmentally friendly appearance (Chemat et al., 2011)

Ultrasonic treatment assisted the crystallization process in two ways: firstly, power ultrasonic is a very effective tool to create an even solution, which was the starting substance for crystallization. In the second stage, ultrasonic supported the

formation of a large number of nuclei. Whilst poor nucleation created a lower number of large crystals, efficient nucleation forms a large amount of small fine-size crystals. Thus, the ultrasonic modification of crystallization is interesting for the formulation of candies, spreads, ice cream, whipped cream and chocolate.

Within an ultrasonic field, nucleation is initiated at higher temperatures or in shorter times resulting in more uniform and smaller crystals. Thus, the advantage over the conventional approaches in the following ways:

- 1) Better product and process consistency
- 2) Improved crystal purity
- 3) Ameliorated secondary physical properties (flowability, packing density, etc.) of the product
- 4) Shorter crystallization cycle times and less frequent rework (Deora et al., 2013)

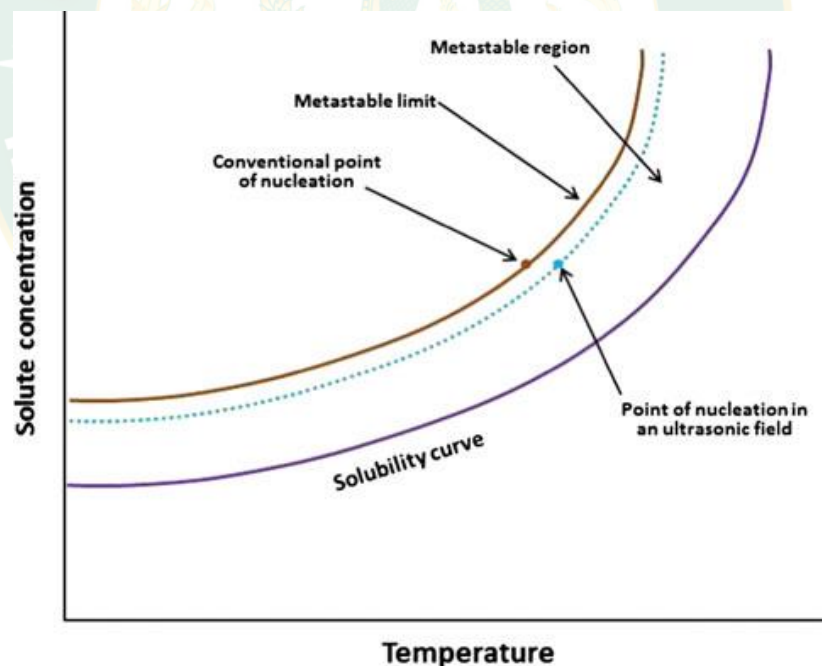

**Figure 9** Schematic diagram of reduction in the metastable zone using ultrasonic

**Source :** Deora et al. (2013)

The zone between the solubility curve and the metastable limit curve (unstable boundary) is known as metastable zone width (MZW). It provides useful

information for developing a controlled crystallization process. The ultrasonic treatment can be induced MZW narrowed as shown in Figure 9, ultrasonic could decrease the apparent order of the primary nucleation rate and increase the rate of appearance of the solid. The application of ultrasonic to crystallization as following:

- 1) Nucleation at the lowest level of supersaturation where the crystallization overcomes the tendency the compound to re-dissolve in the solution.
- 2) Narrowing of the metastable zone width (MZW).
- 3) Narrow particle size distribution.
- 4) Decrease in the level of undercooling necessary to achieve crystallization.
- 5) Increased repeatability and predictability of crystallization.

It should be noted that when ultrasonic is used to enhance crystallization of any kind, there is an additional benefit in that it helps to prevent encrustation of crystals on the cooling elements, which ensures efficient heat transfer throughout the cooling process (Deora et al., 2013).

Ultrasonic assisted-crystallization or well known in name of “sonocrystallization”, this word explain in sonocrystallization consists in the use of power ultrasound to control the course of a crystallization process. The application of power ultrasound to crystallizing systems appears to offer significant potential for modifying and improving both processes and products as power ultrasound offers an additional and highly flexible method of control. The application of ultrasound to a crystallization operation process may bring the following advantages such as decreasing of MZW, controlling initiation of nucleation and improvement in crystal shape and habit (Narducci, 2012).

### **2.6.2 Control of crystallization process with ultrasonic treatment in honey**

Ultrasonic treatment or Sonication is an alternative processing for many liquid food products as honey. Its mechanical power is being used for a gentle yet effective microbial inactivation and particle size reduction. When honey is exposed to ultrasonic treatment, most of the yeast cells are destroyed. Yeast cells that survive sonication generally lose their ability to grow. This reduces the rate of honey

fermentation and also eliminate existing crystals and inhibit further crystallization in honey (Kabbani et al., 2011). Moreover, the ultrasonic may be the method to control the nucleation phenomena and control crystallization behavior during creamed honey production. Cavitation appears to be particular effective as a means of inducing nucleation and there is evidence of dramatic improvements in reproducibility obtained through such sono-nucleation. In addition, acoustic-induced nucleation is a well-defined initial point for the crystallization process which permits better modulation of crystal growth. Moreover, sono-nucleation may eliminate the need for crystal seeding (Deora et al., 2013).

High powered ultrasonic can assist the crystallization process (ultrasonic-assisted crystallization) in several ways, such as influence the initiation of crystal nucleation, control the rate of crystal growth, formed the ensuring small and even-sized crystals, and prevent fouling of surfaces by the newly formed crystals. If the processes are not well controlled, nucleation and subsequent crystallization can occur randomly which generally produce a poor product quality. This can be of considerable financial significance in a large commercial process.

Ultrasonic-assisted crystallization results in the formation of small, evenly sized crystals. Their small size appears to be related to the large number of nuclei that can develop and is not simply due to the fragmentation of large crystals. Crystal morphology can in certain cases be affected by ultrasonic, however their size can be significantly reduced with increased power input. Similarly, the rate of nucleation can increase with increasing ultrasonic power at reduced frequency. Ultrasonic crystallization technology can be applied to foods where it can be used to control the size and rate of development of ice crystals in frozen foods. As food is frozen, small crystals form within matrix. With conventional freezing, the time taken from the initiation of crystallization to complete freezing can be length, and then during storage the crystals can expand. Freezing using ultrasonic ensures rapid and even nucleation, short dwell times and the formation of small, evenly sized crystals, greatly reducing cellular damage and preserving product integrity, even on thawing.

Moreover, ultrasonic-assisted crystallization has been reported to improve the crystallization of organic compounds of low to medium molecular weight

pharmaceuticals. In food industries, ultrasonic treatment is an interesting application for controlling of sugar crystallite size. Since the texture of food products will be affected by the size of undissolved sugar crystals so this application is of particular interest. Rucroft et al. (2005) investigated the effect of ultrasound treatment on the metastable zone width reduction for sugar solutions cooled from 50 to 20°C except D-lactose. In honey product, there were many researchers who reported about the beneficial application of power ultrasonic in honey. It was shown in eliminating existing crystals and also retard the crystallization process resulting in a cost-effective technology (Kabbani et al., 2011; Kabbani D. et al., 2011; Liebl, 1977; Thrasyvoulou et al., 1994).

When honey was exposed to ultrasonic waves or heated, the sugar crystals re-dissolve to a liquid state. This group reported that ultrasonic-treated honey presents a clearer appearance than heat treatment alone. Another important finding from this study that honey could be liquefied by ultrasound waves without the need to increase the temperature to 50°C or higher (Kabbani et al., 2011).

There were many researchers studying about ultrasonic treatment with honey processing (Table 9). Because ultrasonic treatment offers an effective method, crystals in honey was liquefied and destroyed the yeast, without affecting the quality of honey. Moreover, controlled ultrasonic treatment allowed to initiate the crystal seeding (creation of nuclei) and to influence the crystal growth.

**Table 10** Reviews of ultrasonic treatment with honey

No.	Reviews	Honey types	method	condition	Objective	Conclude
1	Preliminary report on the effect of ultrasonic waves on the crystallization of honey	-	Ultrasonic	9 kHz	Liquefaction and pasteurization	<ul style="list-style-type: none"> <li>- eliminated the existing the crystals and retarded further crystallization in honey.</li> <li>- destroyed most of the yeast cells and presented honey without crystals.</li> <li>- inhibited granulation at 16°C for 15 months comparing with heating only.</li> </ul>
Kaloyereas (1955)						
2	Liquefying crystallized honey with ultrasonic waves	5 samples of blossom honey and 5 samples of honeydew honey from pine forest	Conventional and ultrasonic treatment	US 23 kHz and heating at 60°C for 30 min	Liquefaction	Lower time and less energy of liquefaction by US treatment without effect with honey quality.
Thrasyloulou et al. (1994)						
3	Microwave and Infrared Heat Processing of Honey and its Quality	Forese/Rock bee honey extracted from <i>Apis dorsata</i> hives	Microwave and infrared radiation	Different power levels 10 -1000 (175-850W), 15-90 s	Heating	Infrared heating was not as rapid as microwave heating but achieved desired results in a relatively shorter period (3-4 s) offering advantage over the conventional method
Hebbar et al. (2003)						
3	High-power US to Control Honey Crystallization	100 g of commercial creamed honey from Capilano Honey Ltd.	Ultrasound treatment	24 kHz with 40 mm sonotrode with 12 μm amplitude	Liquefaction	The most of crystals were dissolved and the creamed honey was liquefied.
D'Arcy, Bruce (2007)						



**Table 11** Reviews of ultrasonic treatment with honey (Continue)

No.	Reviews	Honey types	method	condition	Objective	Conclude
4	Effect of Sonication on the Crystallization of Honeys	Bright lime nectar honey and dark buckwheat nectar honey	Ultrasonic	40 kHz, 2 W/cm <sup>2</sup>	crystallization	Non-sonicated samples were presence in the biggest crystals. Thus, the ultrasound treatment modified the course of recrystallization and resulting the texture of recrystallization by decreasing the hardness.
	Stasiak and Dolatowski (2007)					
5	Effect of US and high hydrostatic pressure (HHP) on liquefaction and quality parameters of selected honey varieties	Sunflower, cotton and canola honey from Balpamak Honey Company (Turkey).	HHP comparing with ultrasound	HHP: 220-330 MPa, 50-60°C US: 24 kHz	Liquefaction	US is advantage in shorter time, slight changes in quality and ease in operation. HHP treatments is also an alternative method with shorter application time and lower HMF values.
6	Ultrasound-assisted liquefaction of rosemary honey: influence on rheology and crystal content	Rosemary ( <i>Rosmarinus officinalis</i> ) commercially honey (Alicante)	US bath comparing with heating bath	US: 40 kHz, 40, 50, 60°C, 60 min Heating: 40, 50 and 60°C, 60min	Liquefaction	US speeds up the liquefaction of honey especially at temperature <50°C and preserve the honey's quality and save the energy consumption.
7	Melting of crystallized sunflower honey by high power ultrasonic method	Sunflower honey	Ultrasonic	20 kHz, 5 level watt	Liquefaction	The optimum melting condition was at 52 W for 1 hour and it could maintain quality of the sunflower honey in a similar manner as natural honey
	Nunta and Intipunya (2013)					

**Table 12** Reviews of ultrasonic treatment with honey (Continue)

No.	Reviews	Honey types	method	condition	Objective	Conclusion
8	Effects of conventional and ultrasound treatments on physicochemical properties and antioxidant capacity of floral honeys from Northern Thailand Chaikham et al. (2016)	Longan flower, lychee flower and wildflower honeys from Lamphun and Chiang Mai provinces	Ultrasonic comparing conventional thermal	US: 40% and 80% amplitudes, 20 kHz, 30 min Heat: 90°C for 5min	Heating	Ultrasonication (with low amp.) is an alternative preservation technique for maintaining the quality of all honey samples
9	Effects of drying method on stable and quality of stingless bee honey Sumit Kunjet et al. (2017)	Stingless bee honey	Drying oven	Temperature of 0, 40, 60 and 70°C	Drying	Drying at 40 and 60°C was the highest in humidity, sweetness, brightness and sugar content and HMF was not exceed 80 mg/kg
10	Effects of liquefying crystallized honey by ultrasound on crystal size, 5-hydroxymethylfurfural, colour, phenolic compounds and antioxidant activity Quintero-Lira et al. (2017)	Crystallized honey from 5 geographic regions of the State of Hidalgo Mexico with different botanical origin	Ultrasonic	42kHz for 5, 10, 15min	Liquefaction	US treatments exhibited significant differences in crystal size, colour and antioxidant activity (DPPH) but not in HMF (p>0.05). US is an alternative to thermal treatment of the honey decrystallization without changing the HMF.
11	Effects of ultrasound and high pressure on physicochemical properties and HMF formation in Turkish honey types Önür et al. (2018)	Sunflower, cotton and canola from Balparmak Honey Company, Turkey	HHP comparing US treatment	HHP (P=220-330 MPa, 50°C for 23min and 60°C for 106min) US (24kHz)	Liquefaction	The best process conditions for maximizing liquefaction were found to be HHP at 50°C for 106 min and 7 mm probe with 0.5 cycles for US treatment.

## 2.7 Mathematical model involving crystallization behavior

The birth of a new crystal which we have called nucleation, refers to the beginning of the phase separation process. The solute molecules have formed the smallest sized particles possible under the conditions present. The next stage of the crystallization process is for these nuclei to grow larger by the addition of solute molecules from the supersaturated solution. This part of the crystallization process is known as crystal growth (Myerson, 2002). Crystal growth involved with diffusion from bulk of the solution to crystal surface and reaction onto the crystal surface. The overall growth rate ( $G$ ) is the rate of change of the crystal size ( $L$ ) with time ( $t$ ) and can be expressed as.

$$G = \frac{dL}{dt} = k_g \Delta c^g \quad \text{Eq. (6)}$$

Where

$k_g$  = the overall growth rate constant

$\Delta c$  = the supersaturation

$g$  = the order of growth rate (Myerson, 2002)

The properties of the crystals obtained depend on both nucleation and crystal growth and their relationship to each other. When the rate of nucleation is high relative to the growth rate, crystals formed are small and numerous (Deora et al., 2013).

The crystal growth rate may be characterized in many ways. The transport of material was occurred in crystallization into two stages which including a diffusional step and a surface deposition step. A diffusional step where solute is transported from the bulk fluid through the solution film to the crystal surface and a surface deposition step where adsorbed solute is deposited and integrated into the crystal lattice. The growth rate equation may be expressed:

$$\frac{dm}{dt} = k_d A(c - c_i) = k_r A(c_i - c^*)^i \quad \text{Eq. (7)}$$

where  $m$  = mass deposited in time,  $t$

$A$  = crystal surface area,

$c, c_i, c^*$  = solute concentrations in bulk solution, at the interface and at the equilibrium saturation respectively.

$k_d, k_r$  = diffusion and deposition (or reaction) transfer coefficients respectively.

$i$  = order of deposition kinetics

Since it is impossible to obtain the interfacial concentration, an overall concentration driving force,  $\Delta c$  is used (Myerson, 2002), where

$$\Delta c = (c - c^*) \quad \text{Eq. (8)}$$

To measure the concentration for analyzing of glucose monohydrate crystal growth in creamed honey by using the glucose/water ratio (G/W), the driving force will be changed to:

$$\Delta c = \left( \frac{G}{W} - \left[ \frac{G}{W} \right]^* \right) \quad \text{Eq. (9)}$$

For a single crystal, the mass deposition rate is linked to the linear growth rate (in terms of the volume equivalent length) by:

$$\frac{dm}{dt} = \left( \frac{\pi}{2} \right) \rho_c L^2 G \quad \text{Eq. (10)}$$

where  $\rho_c$  = density of glucose monohydrate crystal

$L$  = volume equivalent size of crystal

$G$  = linear growth, where  $G = dL/dt$ , ( $G$  is usually related to the overall driving force by,  $G = K_g (\Delta c)^a$ )

$K_g$  = overall crystallization rate coefficient

This relationship links the glucose monohydrate growth rate to the driving force and  $\Delta c$ , as an assumed power law (Richardson and Coulson, 2002).

For crystallization of honey, the tendency to granulate would be roughly proportional to the quantity of glucose, fructose and water. This tendency is differed from some function of the fructose/glucose proportional and shown in Eq. (11).

$$\text{Granulation Tendency} = \frac{D - W}{L} = \frac{G - W}{F} \quad \text{Eq. (11)}$$

where            D or G = the percentage of glucose  
                      L or F = the percentage of fructose  
                      W = the percentage of water

For describing the phenomena of above equation, start from crystals form in honey which will occur nuclei and next, nuclei may be already existing glucose monohydrate crystals, colloidal particles, included solids or minute air bubbles. Such inclusions then serve to stimulate crystal formation, roughly in proportion to their amount and number (Dyce, 1931a).

Not only the mass transfer used for predicting the crystallization kinetics, but also heat transfer could applied for prediction. Regarding different samples will reach in different final enthalpy values, in order to compare the evolution of the crystallization process, the maximum value was considered as 1, and will consider the increase of the relative crystallized fraction (X) during storage.

Honey crystallization kinetics were evaluated using empirical model:

An empirical model; the following power law equation has been applied:

$$\frac{X_t}{X_0} = e^{\alpha t} \quad \text{Eq. (12)}$$

where             $X_t$  = the crystallized glucose fraction at time t

$X_0$  = the crystallized glucose fraction at time 0

t = time (d)

$\alpha$  = rate parameter that defines an exponential growth or decline depending whether it is positive or negative

$\beta$  = a shape factor related to the concavity (when  $\beta$  is 0 or 1, the equation describes a zero or first empirical order kinetic) (Dettori et al., 2018).

Regarding to the smooth texture of creamed honey product will occurred in low temperature, so the crystallization rate of a sugar solution below room or subzero temperatures is a matter of practical as well as academic interest. The rate of crystallization may be hypothetically related to the mobility, so the viscosity of the honey as a glass. The mathematical properties of a material, at temperatures above the glass transition temperature ( $T > T_g$ , e.g.  $T_g + 100K$ ), such as the characteristic relaxation time, and the viscosity can be predicted by William-Landel-Ferry (WLF) equation. When the property is viscosity or crystallization behavior, the WLF equation is described by:

$$\log_{10} \frac{\mu}{\mu_g} = \frac{-C_1(T - T_g)}{C_2 + (T - T_g)} \quad \text{Eq. (13)}$$

$$\log_{10} \frac{t_c}{t_g} = \frac{-C_1(T - T_g)}{C_2 + (T - T_g)} \quad \text{Eq. (14)}$$

Where  $\mu$  = the viscosity

$\mu_g$  = the viscosity at glass transition temperature ( $T_g$ )

$t_g$  = isothermal crystallization time at  $T_g$

$T$  = temperature

$t_c$  = isothermal crystallization time at temperature( $T$ )

$C_1$  and  $C_2$  = “universal” constants, 17.44 and 51.6 K, respectively

However, Eq. (13) using for an amorphous sucrose-lactose-water system and Eq. (14) using for an amorphous sucrose-fructose-water system. Finally, the  $T_g$  embraces the influence of all sugars in an aqueous system, so use of  $T_g$  can also be a useful tool to predict crystallization behavior of honey (Bhandari et al., 1999).

### 2.7.1 Crystal growth kinetics

The development and operation of industrial crystallization processes can be made significantly easier if some data on the kinetics of crystal growth are available.

This information can be incorporated in process models, can be used in process and crystallizer design, and can shed light on the observed behavior of the system. In general, two basic expressions are used to express the relationship between supersaturation and crystal growth. These were equation (10) employs a linear crystal growth velocity (length/time) (Myerson, 2002).

$$G = k_g \Delta C^g \quad \text{Eq. (15)}$$

$$R_g = K_g \Delta C^g \quad \text{Eq. (16)}$$

For Eq. (15) will employ a mass rate of crystal growth (mass/area time). The constant in Eq. (15) and Eq. (16) can be related to each other through the expression

$$K_g = 3 \frac{\alpha}{\beta} \rho k_g \quad \text{Eq. (17)}$$

Typical units for the growth constants are for  $k_g$

$$\frac{m}{s \left[ \frac{(kgsolute)}{kgsolvent} \right]^g} \quad \text{or} \quad \frac{kg}{sm^2 \left[ \frac{(kgsolute)}{kgsolvent} \right]^g}$$

The power  $g$  in the growth equations does not depend on the form of the equation used and is normally a number between 1 and 2.

The constants  $k_g$  and  $K_g$  are temperature-dependent and are usually fit to the Arrhenius equation to obtain a general expression for growth rate as a function of temperature. The Arrhenius equation can be written as Eq. (18).

$$k_g = A \exp\left(\frac{E_G}{RT}\right) \quad \text{Eq. (18)}$$

where  $A$  = constant  
 $E_G$  = Activation energy

The activation energy can be used to obtain information of whether the rate-controlling step is diffusion or surface integration. A complete crystal growth expression that includes both the effect of temperature and supersaturation on the growth rate would, therefore, be written as

$$G = A \exp\left(\frac{-E_G}{RT}\right) \Delta C^g \quad \text{Eq. (19)}$$

### 2.7.2 Crystalline systems

If the aim is to obtain a certain product having a specific crystal size distribution, grain size, and purity instead of a random product, it is necessary to control the local and mean supersaturation as well as the residence time of the solid in the supersaturated solution.

Supersaturation is a prerequisite for nucleation and growth of crystallization. The degree of supersaturation is determined by the flows of materials and energies, on the one hand, and by the crystallization kinetics, such as nucleation and growth.

The solidification of solute molecules on a crystal is accomplished by heat effects. The heat of crystallization is the negative value of the heat dissolution. The heating effect involved when a solid  $i$  dissolves in liquids or when a substance  $i$  crystallizes out of solutions can be calculated if the activity  $a_i$  or the activity coefficient ( $\gamma_i = a_i/y_i$ ) is known in relation to temperature. The differential heat of solution ( $\Delta H_i^*$ ), which describes the heating effect when this solid  $i$  dissolves in a solution that is almost saturated, and express in Eq. (20).

$$\Delta H_i^* = -k \left[ \frac{\partial \ln a_i^*}{\partial (1/T)} \right]_p \quad \text{for } a_i \rightarrow a_i^* \quad \text{Eq. (20)}$$

The solid and fluid phases are practically in equilibrium, which explains why the values  $\Delta H_i^*$  and  $a_i^*$  have an asterisk. As the value  $\Delta H_i^*$  represents the heating effect of the last soluble molecules, this is known as the last differential heat of solution. The negative value of  $\Delta H_i^*$  represents the heat of crystallization, which is



either given off or taken up during crystallization. First differential heat of solution is the term that applies when a substance  $i$  is dissolved in a pure solvent or in an infinitely diluted solution. The entire heat of solution is the energy released or absorbed when a solute is added isobarically/isothermally to a pure solvent until a specific concentration is obtained and expressed as Eq. (21).

$$\Delta H_i^* = -k \left[ \frac{\partial \ln a_i^*}{\partial (1/T)} \right]_p \quad \text{for } a_i \rightarrow 0 \quad \text{Eq. (21)}$$

If the mixtures are ideal,  $a_i = y_i$  or  $\gamma_i = 1$ , so the equation (20) then becomes to Eq. (22).

$$\Delta H_i^* = -k \left[ \frac{\partial \ln y_i^*}{\partial (1/T)} \right]_p \quad \text{Eq. (22)}$$

In this case, the heat of solution is equal to the heat of fusion of a pure substance, Eq. (22) can be written in the form as Eq. (23).

$$\frac{\partial (\ln y_i^*)}{\partial (\ln T)} = -\frac{\Delta H_i^*}{kT} \quad \text{or} \quad \frac{\partial (\ln C_i^*)}{\partial (\ln T)} \approx \left( -\frac{\Delta H_i^*}{kT} \right) \quad \text{Eq. (23)}$$

It will be shown that the slope  $\partial (\ln C_i^*) / \partial (\ln T)$  of the solubility curve or the heat of crystallization is very important for the decision on the mode of crystallization and also for the problem of encrustation.

Heat balances can easily be established in enthalpy-concentration diagrams for binary systems. In such diagrams, the molar enthalpy  $H$  (or the specific enthalpy,  $h$ ) is plotted against the mole fraction  $y$  (or the mass fraction,  $w$ ) with isotherms as a parameter. The molar enthalpies of the pure substances are the product of the molar heat capacities and the temperature,  $H = C_p T$ .

### 2.7.3 Activated nucleation

Crystals are created when nuclei are formed and then grow. The kinetic processes of nucleation and crystal growth require supersaturation, which can generally be obtained by a change in temperature (cooling in the case of a positive gradient  $dC^*/dv$  of the solubility curve or heating in the case of a negative gradient), by removing the solvent (usually by evaporation), or by adding a drowning-out agent or reaction partners.

The system then attempts to achieve thermodynamic equilibrium through nucleation and the growth of nuclei. If a solution contains neither solid foreign particles nor crystals of its own type, nuclei can be formed only by homogeneous nucleation. If foreign particles are present, nucleation is facilitated, and the process is known as heterogeneous nucleation. Both homogeneous and heterogeneous nucleation take place in the absence of solution-own crystals and are collectively known as primary nucleation. This occurs when a specific supersaturation, known as the metastable supersaturation ( $\Delta C_{met}$ ), is obtained in the system. However, it has often been observed that nuclei occur even at a very low supersaturation ( $\Delta C < \Delta C_{met}$ ) when solution-own crystals are present, such as in the form of attrition fragments or added seed crystals). Such nuclei are known as secondary nuclei. However, it should be noted that a distinction is made between nucleation resulting from contact, shearing action, breakage, abrasion, and needle fraction (Figure 10).

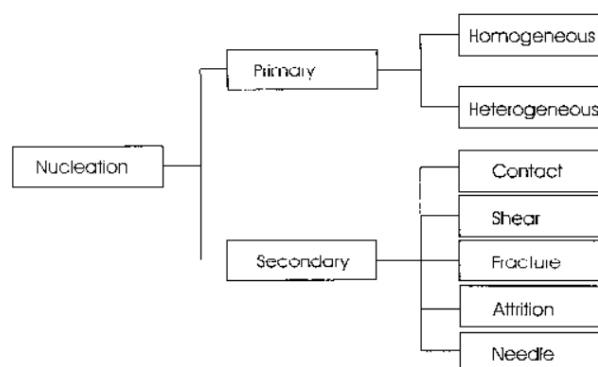

**Figure 10** Various kinds of nucleation

Source : Mersmann et al. (2001)

### 2.7.4 Crystal growth

The growth of crystals in a supersaturated solution is a very complex process that has not been well understood up to now. The reason for this is that many subsequent steps have to take place before a growth unit from the bulk solution is incorporated into the crystal lattice. Only a few of these steps are sufficiently understood to allow a predictive calculation of growth rates. Moreover, a variety of growth units (atoms, molecules, ions, hydrated solute molecules, dimers, trimers, polymers, clusters, etc.) exists depending on the crystallizing system and the solvent, which complicates the situation even more.

In the more universal model, a crystal surface grows in such a way that units (atoms, molecules, ions) in a supersaturated solution (or generally in a supersaturated fluid) are first transported by diffusion and convection and then built into the surface of the crystal by integration or an integration reaction, with the supersaturation,  $\Delta C$  or  $\Delta c$ , being the driving force. This is demonstrated by Figure 11, in which a crystal surface and a continuous solution are represented with concentration profiles of the solute.

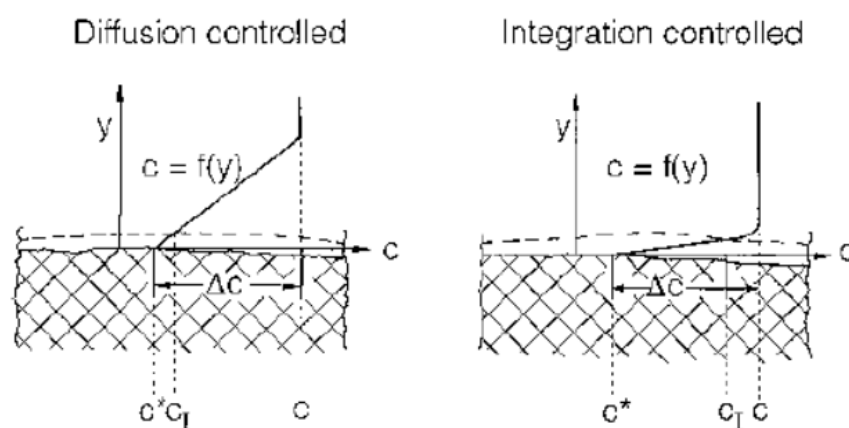

**Figure 11** Concentration profiles for growth that is limited by diffusion or integration

Source : Mersmann et al. (2001)

Before reflecting on the general case of a superposition of mass transport and integration mechanisms, two special regimes should be considered first: the control of crystal growth by diffusion/convection or by the integration reaction.

1) Diffusion-Controlled crystal growth

When the integration reaction is indefinitely fast ( $k_r \rightarrow \infty$ ), crystal growth is determined by the diffusive-convective transport of units. In this case,

$$c - c_l \approx c - c^* = \Delta c$$

And the following is obtained when the mass flux density is low

$$\dot{m} = k_d \Delta c \quad \text{Eq. (24)}$$

or

$$G = \frac{\beta}{3\alpha} k_d \frac{\Delta c}{\rho_c} \quad \text{Eq. (25)}$$

For the mass transfer coefficients ( $k_d$ ) provided in the literature and the equations given for them, it must be determined whether they concern equimolar diffusion or mass transfer to a semipermeable interface. Moreover, it is necessary to find out whether transport is merely diffusive or both diffusive and convective. The difference increases with mass flux density and can be considerable if the substances are highly soluble.

If  $k_d$  is used to denote purely diffusive or true mass transfer coefficients and  $k_{d,s}$  the mass transfer coefficients at a semipermeable interface, which is generally the case in crystal growth, the following applied into Eq. (26).

$$k_{d,s} = \frac{k_d}{1 - w_i} \quad \text{Eq. (26)}$$

If the mass fraction,  $w_i$ , tends toward zero,  $w_i \rightarrow 0$ , then  $k_{d,s} = k_d$ . The mass transfer coefficient determining the slope of the linear relationship of the growth rate and supersaturation, Eq. (27), may be related to the Sherwood number ( $Sh$ ) and therefore to fluid dynamics, particle size, diffusivity, and viscosity.

$$Sh = \frac{k_d L}{D_{AB}} \quad \text{Eq. (27)}$$

## 2) Integration-Controlled crystal growth

When the diffusive/convective transport of units takes place rapidly (mass transfer coefficient  $k_d \rightarrow \infty$ ) or the integration reaction takes place very slowly,  $k_r \rightarrow 0$ , crystal growth is determined by the integration reaction occurring on the crystal surface. The individual processes involved can be diverse and complex and therefore are difficult to understand. A possible integration inhibition may consist, for example, of foreign particles or impurities being adsorbed on the crystal surface.

### 2.7.5 Crystal growth and heat effects

The heat of crystallization generated at the crystal-solution interface creates a temperature field in this area. The supersaturation that is decisive for crystal growth is now different than that which was calculated on the basis of the equilibrium concentration in an isothermal field. In the case of an exothermic specific heat of crystallization ( $\Delta h^*$ ), the generation of heat at the crystal surface is given by the relationship of

$$\Delta h^* \frac{G}{2} \rho_c = h(T_i - T) \quad \text{Eq. (28)}$$

Where

- $h$  = the heat transfer coefficient
- $T$  = the bulk temperature
- $c$  = the bulk concentration
- $c^*$  = the equilibrium concentration at the temperature  $T$

The corresponding parameters at the crystal-solution interface are denoted as  $T_I$ ,  $c_I$  and  $c_I^*$ . Within a small temperature range, the following equation can be written

$$c_I - c^* = (T_I - T) \frac{dc^*}{dT} \quad \text{Eq. (29)}$$

Where  $dc^*/dT$  is the slope of the solubility curve. If the heat transfer coefficient  $h$  is described by the Nusselt number,  $\left(Nu = h \frac{L}{\lambda_L}\right)$  and Eq. (28) and (29) are combined, the following is obtained in Eq. (30).

$$c_I - c^* = \frac{G \rho_c L \Delta h^*}{(2Nu) \lambda_L} \frac{dc^*}{dT} \quad \text{Eq. (30)}$$

Limitation of the growth rate by volume diffusion alone results in the greatest amount of growth and generation of heat possible. The growth rate can be expressed by

$$\frac{G}{2} \rho_c = k_d (c - c_I) = k_d [(c - c^*) - (c_I - c^*)] \quad \text{Eq. (31)}$$

If the mass transfer coefficient  $k_d$  is expressed by the Sherwood number ( $Sh$ ),  $(c - c_I)$  can be eliminated from Eq. (30) and (31), giving

$$G \left( 1 + \frac{D_{AB}}{\lambda_L} \Delta h^* \frac{dc^*}{dT} \frac{Sh}{Nu} \right) = 2k_d \frac{c - c^*}{\rho_c} \quad \text{Eq. (32)}$$

or with the bulk supersaturation  $\sigma$ ,

$$G = \frac{2k_d}{1 + \psi (Sh/Nu)} \frac{c^*}{\rho_c} \sigma = \frac{2k_d}{1 + \psi (Sh/Nu)} \frac{\Delta c}{\rho_c} \quad \text{Eq. (33)}$$

Where 
$$\psi = \frac{D_{AB}}{\lambda_L} \Delta h^* \frac{dc^*}{dT}$$

$$Sh(\text{or } Nu) = a Re^{1/2} [Sc(\text{or } Pr)]^{1/3} \quad \text{Eq. (34)}$$

$$\frac{Sh}{Nu} = \left( \frac{Sc}{Pr} \right)^{1/3} = Le^{1/3} \quad \text{Eq. (35)}$$

Where  $Le$  or  $Le = \frac{\lambda_L}{\rho c_p D_{AB}}$  is the Lewis number. The correction factor in this case is  $1 + \Psi(Le^{1/3})$ .

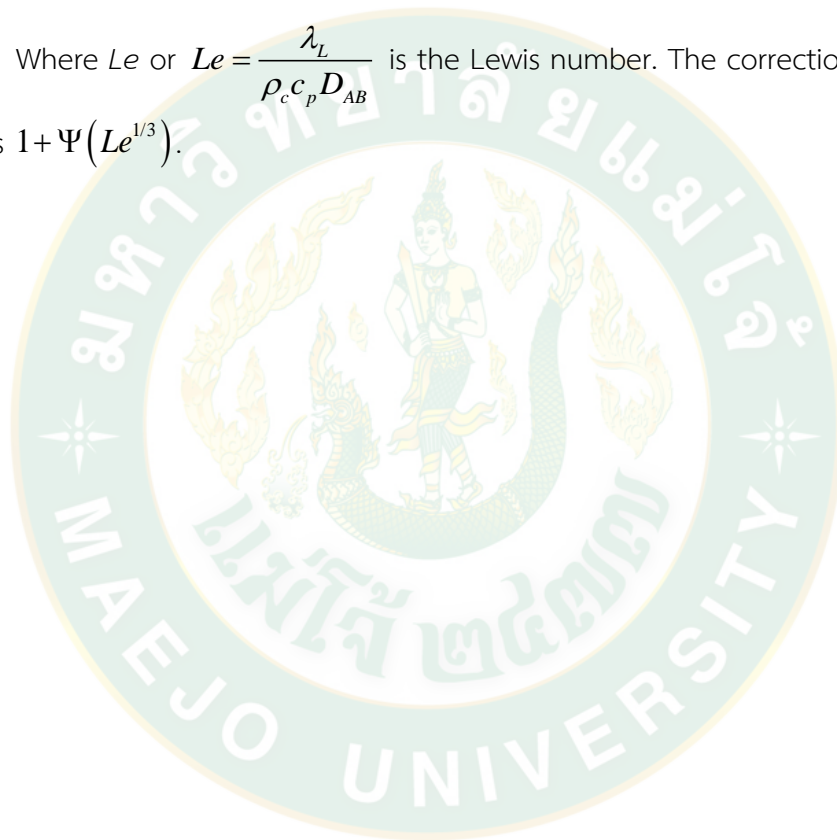

## CHAPTER 3

### METHODOLOGY

This chapter described the methodologies of optimization a method to produce creamed honey, shelf-life evaluation and crystallization model for describing the crystallization behavior of creamed honey. All of experiment were used honey which were purchased from Supha Bee Farm, Chiang Mai province, Thailand, with a guarantee type, origin, and known history. The overall flow of research methodology with their respective and interrelationship are presented in Figure 10. The chemical and equipment are summarized below.

#### Material and method

##### Chemical and equipment

1. Analytical Balance (Pioneer, OHAUS, PA214, USA)
2. Ultrasonic bath (UC-150, Sturdy Industrial, Taiwan)
3. Ultrasonic bath (JP-040S, China)
4. Thermostatic bath (Julabo, Germany)
5. Hot Air Oven (Mettmert, Germany)
6. Vacuum Far-Infrared Dryer (Maejo University, Thailand)
7. Differential Scanning Calorimeter (DSC, Mettler-Toledo DSC 1 Module with the STARe software, Switzerland)
8. HPLC (1100 series, Agilent Technology, USA)
9. Brookfield disc-type viscometer (model DV -III ULTRA, Brookfield Engineering Labs. Inc, Sotughton MA 02346, USA)
10. Optical Microscopy (Olympus, model BX51)
11. Spectrophotometer (HunterLabMiniScan XE Plus) on the CIELAB scale ( $L^*$ ,  $a^*$  and  $b^*$ )
12. Spectrophotometer (Model SPECTRO SC, U.S.A.)
13. Abbe refractometer (KRUSS, Germany)
14.  $a_w$  meter (AQUA lab, 3 TE, Washington)



15. Texture Analyzer (TA.XT2i.plus, UK)
16. Hand refractometer (RHB-90ATC, Brix 58 -90%)
17. Heating and Cooling bath
18. 100W Precision Digital LCD and stirrer Mixer
19. Digital thermometer
20. Distilled water

The objective of research performed under high controlling of honey specification to develop the creamed honey production to achieve the best texture, good spreadability and stability of creamed honey product. The experimental was divided into four section.

#### **Raw material and sample preparation**

Sunflower, longan, lychee, and wild honey (fresh and non-crystallized honey) were purchased from Supha Bee Farm, Chiang Mai province. Coffee and longan honey in section 3.1.1 were from Lumphun and Chiang Mai province. All item of honey in this research is the honey in Thailand. Before analyzed in every part, honey samples were heated at 50°C to eliminate natural crystals and osmotolerant/osmophilic yeasts by using a water bath. Heated honey samples were cooled to room temperature and stored in labelled glass containers at 25-30°C (average temperature in Chiang Mai province, Thailand). The liquid honey samples were further analyzed in physicochemical and thermal properties in the state of raw material in creamed honey product preparation.

The seed honey prepared from a natural crystallized honey which is the coarse crystals within the set honey. These feel gritty on the tongue. Coarse crystals seed honey was grinded with the pestle until obtaining a smooth taste. There should be not gritty taste at all, and it would turn lighter and creamy. Mixed the seed with 75%w/w clear liquid honey and take a blender. Blend the two together about 10 times over the course of an hour. Perfectly smooth it has become. Blending will grind the crystals to super smooth seed honey, and it should be as smooth as butter.

Take the glass bottle and place in chilled temperature (10-14°C) for soft set seed honey. However, collect the creamed honey from previously laboratory sample but it was separate in each honey type for preventing the effect of the honey properties with the developed method of creamed honey product.

### Analytical of biochemical compositions

1) Sugar content: honey sugar compositions (glucose, fructose, maltose, and sucrose) were determined by HPLC (Agilent, USA) according to AOAC method 977.20 (2000). The honey solution was filtered through a 0.45- $\mu\text{m}$  filter and immediately injected into an HPLC fitted with a refractive index (RI) detector. The HPLC column was a  $\mu$ -Bondapak carbohydrate column with 4-mm diameter and 300-mm length, and it was operated with the eluting solvent of an acetonitrile:water ( $\text{H}_2\text{O}$ ) ratio of 87:13. The sugar content in the honey samples was calculated using a standard calibration curve.

2) Moisture content: the moisture content was determined into three methods including refractometer and verified the value from the standard reference table of honey refractive indices (Chataway, 1932) and water content, according to the Harmonized Methods of the International Honey Commission (Bogdanov, 2009), determining following AOAC method (Horwitz et al., 1970), and finally, using an Abbe refractometer (KRUSS, Germany). Three samples from each trial were analyzed for the moisture determination, and the average moisture content was reported.

3) Colour: the colour was measured by using Spectrophotometer (HunterLab Miniscan XE plus, Germany) and reported in value of  $L^*$ ,  $a^*$  and  $b^*$ . Calibration of instrument was done with a black and white standard tile before each set of measurements. The  $L^*$  colour value presented the degree of brightness or whiteness of the sample, while  $a^*$  and  $b^*$  color values indicated the degree of redness and yellowness, respectively. Three measurements were done in each sample. All parameters were used to calculate the hue angle ( $h^\circ$ ) and Whiteness Index ( $WI$ ) (Briones and Aguilera, 2005), applied by (Costa et al., 2015) and calculated following Eq. (2) – (5).

4) Texture: texture measurement was made with the TA.XT-PLUS Texture Analyzer (Stable Micro Systems Ltd., UK). Test parameters were selected based on preliminary trials. A conical probe P/60C was used to penetrate a creamed honey samples to a 10-mm depth at a rate of 10 mm/s. For each sample, three replicates were analysed at each sampling time. The acquired curves of Force (N) versus time (s) shows the hardness (N) as the maximum force at the positive highest peak and the adhesiveness (N.s) as the maximum negative force area after compression.

5) Turbidity: honey samples were poured into a cuvette about 1 cm with a path-length. Some trials with many types of liquid honey were taken to scan for wavelength in a range between 200 – 700 nm and presented the smooth curve in range between 600-700 nm. Therefore, the absorbance was measured at 660 nm at room temperature by spectrophotometer (Model SPECTRO SC, U.S.A.) as following trials and literature review (Conforti et al., 2006; Costa et al., 2015; Lupano, 1997).

6) Light microscopy: honey samples were observed at room temperature by light microscopic (Olympus, model BX51TF, Japan), (Lupano, 1997).

### Statistical analysis

As an independent experiment, the results were expressed as mean  $\pm$  standard deviation (mean $\pm$ SD) of triplicate testing. Statistical analysis was performed using analysis of variance (ANOVA), followed by Duncan's multiple range test (DMRT). Duncan's method was employed to analyze the significant difference in responses at  $p \leq 0.05$ . Statistical processing was carried out using SPSS 17. The coefficient of determination ( $R^2$ ) was also calculated to statistically evaluate the accuracy of the mathematical model to simulate any crystallization kinetics.

### 3.1 To study the possibility to produce creamed honey product from various types of honey in Thailand

The crystallization process is impacted by glucose/water ratio, fructose/glucose ratio, pasteurization and storage temperature (Elhamid and Abou-Shaara, 2016). When the crystals are small, the quality of crystallized honey or

creamed honey is highest (Dyce, 1931a). Thus, the factors and method of controlling fine crystallization should be investigating. The physicochemical properties of honey were shown in two principal sugars (glucose and fructose) and the proportions of it were impacted with the form and the size of crystals and further influence with final texture of creamed honey product. Thus, the aim of this objective is investigating on the possibility to produce the creamed honey from various types of honey with best texture, due to several research for glucose and water content adjusting had proposed the below information.

### **3.1.1 To study the honey properties and natural crystallization**

Five types honey (7 samples) were purchased from department store as fresh in Chiang Mai province and kept in room temperature before analyzed for carbohydrates (fructose and glucose), and moisture content. Liquid honey samples were stored up to 84 days at low storage temperature (10 - 15°C) (D'Arcy, 2007) in cover glass bottles allowing spontaneous nucleation and crystal growth to occur (Laos et al., 2011). Thus, formation of honey crystals was physically observed from initial stage (Srinual and Intipunya, 2009) and record the time of honey crystallization until fully crystallization. Crystallization indices and the tendency of crystallization in each honey types were categories in non-, slow, medium, and rapid crystallization (Manikis and Thrasivoulou, 2001).

### **3.1.2 To study the effect of moisture and glucose content to the honey crystallization**

Only honey types which presented in slow and rapid crystallization will study in this part. There were two methods for stimulating in rapidly crystallization, one is to increase the glucose content by adding the glucose powder and second is decrease the water content by dehydration method.

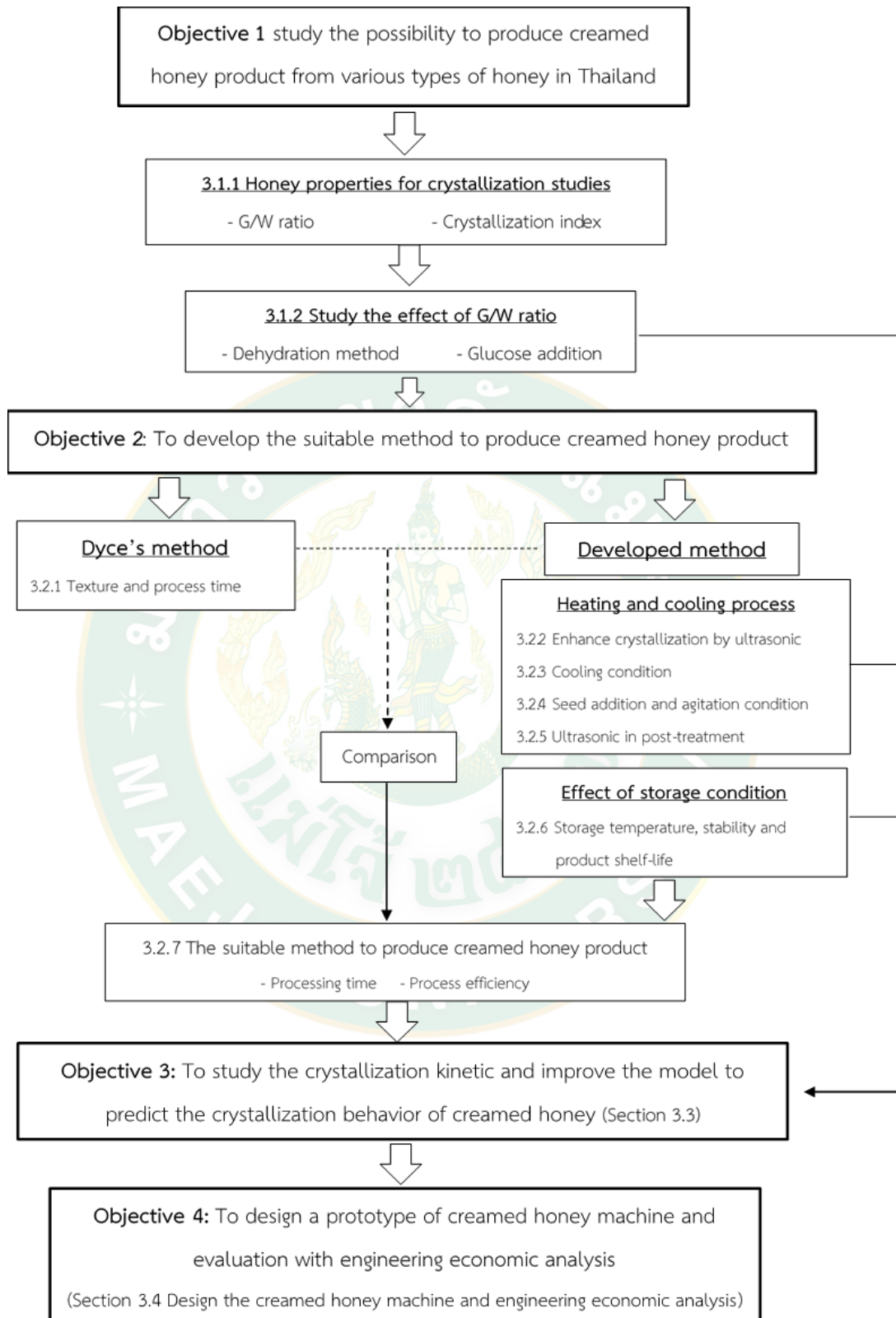

**Figure 12** Flow chart of overall research methodology

1) To study the dehydration method

The glucose/water ratio should be higher than 2.16, the honey will present in rapid crystallization (Bhandari et al., 1999). Therefore, if the water content decreases, the glucose/water ratio will increase and change the crystallization behavior of honey. One method to reduce the water content in honey is the dehydration process by heating in low temperature to preserve the honey quality. Because heating above 50°C will affect the quality and cause protein denaturation and deactivation of several enzymes which are mainly responsible for its functional behavior (Janghu et al., 2017). That is why minimal processing techniques or heating treatment in low temperature is very important and studied for applying in honey dehydration.

Four levels of dehydration temperature were including 35, 45, 55 and 65°C. The dehydration by using vacuum far-infrared dryer were carried out under the conditions: pressures in drying chamber (5 kPa) at temperature at 40°C (Intipunya and Metanee, 2012; Kunjet et al., 2017) and will compare with the dehydration by hot air oven. The dehydration process will monitor until the unacceptable appearance of honey presented. Longan honey is the non-granulating honey which is suitable to study in this part. As mentioned above that the G/W ratio will increase by the reducing of moisture content in honey, so longan honey will use to study in the dehydration method. If the raw material is the honey which is easy to crystallize, it will be easy to control the creamed honey process. The longan honey samples which fixed the initial glucose content and set namely in dehydrated honey and non-dehydrated honey). The moisture content was measured according to the Harmonized Methods of the International Honey Commission (Bogdanov, 2009), and second, the samples were determined the moisture content by the method described by the AOAC (Horwitz et al., 1970). Multiple comparison of moisture means was conducted by Duncan's multiple-range test (Mossel et al., 2000) and the kinetic of dehydration process was analyzed with the G/W ratio variation.

## 2) To study the method of glucose addition

Regarding to the quality of granulated honey or creamed honey, from the stand-point of human taste, depends on size of crystals, and honey with large coarse crystallization is inferior to that with small crystals. Moreover, the small crystals was obtained from only rapid or fast crystallization and glucose content should present to about 34% which is readily crystallized and forms the solid phase of creamed honey (Dyce, 1931a). Thus, this study aims to investigate the possibility to increase the crystallization rate by adding of glucose powder with sunflower and longan honey. Two honey samples were analyze chemical properties including moisture, glucose, water activity and pH values according to the Harmonized Methods of the International Honey Commission (Bogdanov, 2009), and AOAC (Horwitz et al., 1970).

Samples were heated at 50°C to eliminate natural crystals and osmotolerant/osmophilic yeasts by using a water bath (Tosi et al., 2004). Heated honey samples were kept at room temperature before seeding addition. Glucose monohydrous powder (C<sub>6</sub>H<sub>12</sub>O<sub>6</sub>, Merck, Germany) was employed as seed (Elhamid and Abou-Shaara, 2016). Glucose powder was added in both honey types (~40 g of liquid honey), but none was added to the control sample, as shown in Figure 13. Samples were manually stirred with a spatula at room temperature for about 10 min to thoroughly mix between the glucose powder and liquid honey (Dettori *et al.*, 2018). Samples were then stored at a chilling temperature (10 - 15°C) to allow the crystallization process. The temperature in the refrigerator was checked daily during the experiment. Crystallized honey samples were periodically measured for absorbance at different sampling periods and visual observation was conducted to check the overall appearance. If there were crystals occurring throughout the honey sample, it was deemed full crystallization.



(A) Liquid longan honey and glucose powder adding method



(B) longan honey with glucose addition



(C) sunflower honey with glucose addition

**Figure 13** Glucose powder addition method

The moisture content was determined following a refractive index method (Bogdanov, 2009) by measuring the refractive index of honey with a digital Abbe refractometer (KRUSS, Germany). Three samples from each trial were analyzed for determination of moisture, and the average moisture content was reported. Sugar content (fructose, glucose, sucrose, and maltose) was determined by HPLC, according to Official method 977.20 (AOAC, 2000). Water activity was measured by using a water activity meter (AQUA Lab 3TE, USA). Measured of each sample was duplicated, and the average water activity was calculated.



The fresh honey samples which fixed the initial moisture content was divided into four groups, then glucose monohydrated powder ( $C_6H_{12}O_6 \cdot H_2O$ ) was used as seed.

Glucose powder with % of 1.0, 1.5, 2.0 and 2.5 (w/w) was added to the four groups and 0% (w/w) was control by not added glucose powder. The time needed till full crystallization was recorded for each treatment. After full crystallization, samples of crystallized honey of each group were subjected to measure the color. The color was measured by using Spectrophotometer (HunterLab Miniscan XE plus, Germany) and reported in value of  $L^*$ ,  $a^*$  and  $b^*$ . Calibration of instrument was done with a black and white standard tile before each set of measurements. The  $L^*$  colour value presented the degree of brightness or whiteness of the sample, while  $a^*$  and  $b^*$  colour values indicated the degree of redness and yellowness, respectively. Three measurements were done in each sample. All parameters were used to calculate the hue angle ( $h^\circ$ ) and Whiteness Index ( $WI$ ) (Briones and Aguilera, 2005) as following Eq. (2) – (5).

The absorbance measured at 660 nm for monitoring the crystallization kinetic during storage. Honey samples were poured into a cuvette about 1 cm with a path-length. Some trials with many types of liquid honey were taken to scan for wavelength in a range between 200 – 700 nm and presented the smooth curve in range between 600-700 nm. Therefore, the absorbance was measured at 660 nm at room temperature by spectrophotometer (Model SPECTRO SC, U.S.A.) as following trials and literature review (Conforti et al., 2006; Costa et al., 2015; Lupano, 1997). The experiment was designed as completely randomized design (CRD) and analysis of Variance (ANOVA) was performed and means of measured parameters were compared using Duncan Multiple range test at 5% level of significance (Elhamid and Abou-Shaara, 2016).

### **3.2 To develop a suitable method to produce creamed honey product**

The study of this part was carried out to optimize a simple method to produce a creamed honey product which has a good texture, spreadability and stability. However, the fine creamed honey was coming from rapid crystallization and composed of simultaneously of small crystals.

From section 3.1, the different honey types and different physicochemical properties was presented in different rate of crystallization, because its composed of different content of glucose and moisture. The tendency of honey to crystallize depends on its glucose content and moisture level.

Three main factors which were investigated in this part were including the moisture content, the glucose content and ultrasonic treatment. The solution findings should be concluded both in the factor affecting with texture and optimize procedure of its. Moreover, the storage condition for obtain a fine textured and the stability for declare the shelf-life of product. The procedure of creamed honey production will be followed Dyce method (1931), and the experiment design are defined in section 3.2.1 to 3.2.7.

#### **3.2.1 To study the creamed honey production by Dyce's method**

Dyce's method for creamed honey production was shown in Figure 14. Dyce (1931a, b) developed the process for producing creamed honey by starting from heating the honey to 49°C and strained to remove small particles. Honey is again heated to 66°C, cooled rapidly to 24°C, and 5-10% seed honey is added with vigorous mixing. Next, the thoroughly mixed honey is filled into containers, sealed and kept at 14°C, after which a fine textured creamed honey results in 4-6 days. Finally, the finely granulated honey needs to be conditioned at 30°C until a soft texture results or about 10-14 days.

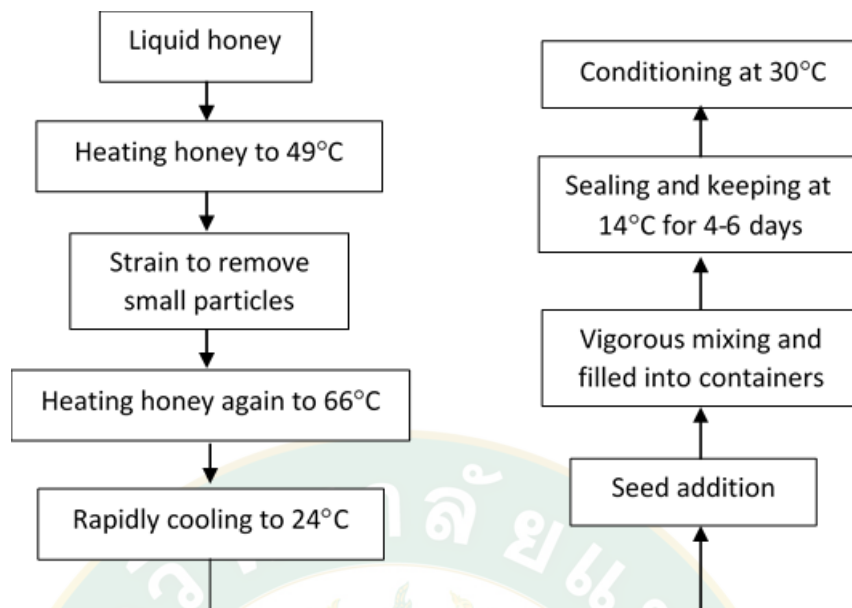

**Figure 14** Process flow chart of creamed honey by Dyce's method

**Source:** Dyce (1931a, b)

The processing time, overall appearance and texture evaluation of Dyce's method will be checked and will be used to compare the process efficiency and product quality with the developed method in part 3.2.7.

### 3.2.2 To study the enhancing crystallization with ultrasonic treatment

From literature review, the ultrasonic treatment is an interesting method that assisted liquefaction and pasteurization in honey products. But ultrasonic assisted crystallization or re-crystallization seems to have less information, especially in honey, thus, the experiment in this part aims to investigate the enhancing of crystallization with ultrasonic treatment in pre-treatment. Moreover, if we can reduce the moisture content in the honey like longan honey which is present in non or slow granulating honey during ultrasonic treatment, it will be a beneficial way to reserve the honey quality during the heating process.

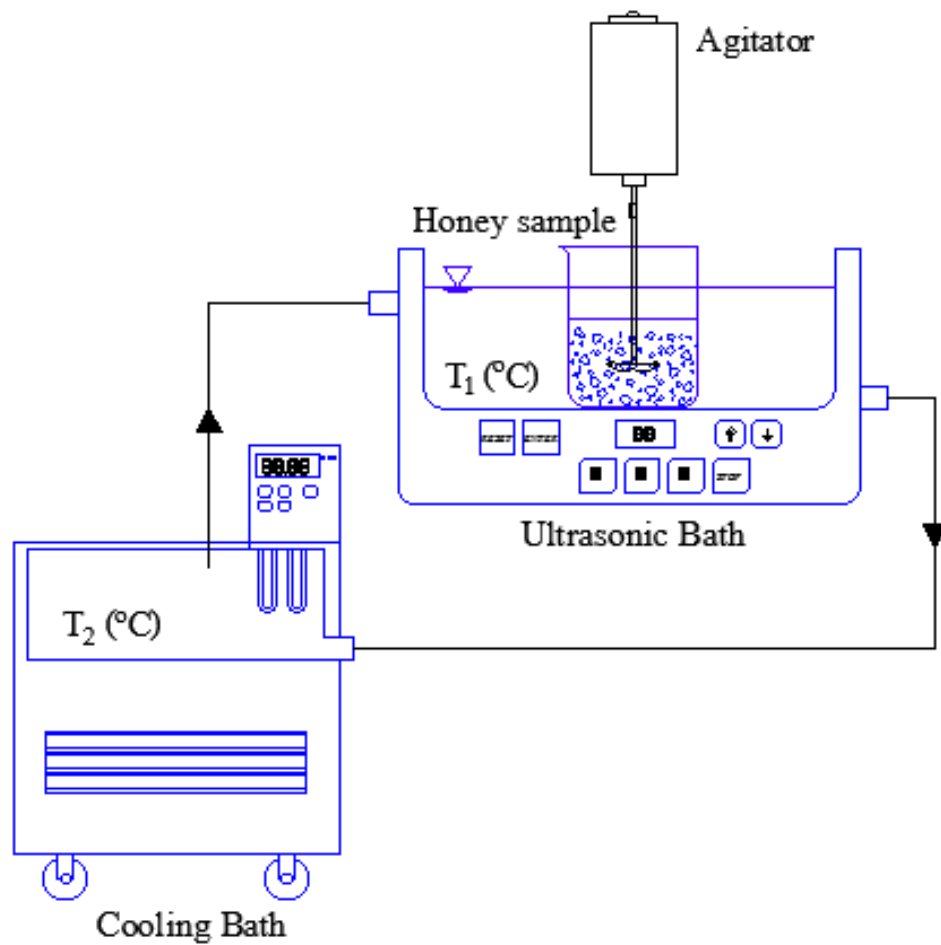

**Figure 15** Schematic diagram of creamed honey production with ultrasonic

The schematic diagram of creamed honey production was shown in Figure 15. The process started from the heating of liquid honey for pasteurization and elimination any crystals in honey. However, the overheating with high temperature and longer time will affect with the enzyme and color of liquid honey. Honey is heated for fast handling, to destroy yeast, to dissolve the large granules, and to increase keeping quality. It is important to control the period of heating and the temperature to prevent overheating and loss of freshness in honey. Thus, heating and cooling must be undertaken rapidly in order to minimize heat damage to the honey. Firstly, honey liquefaction by ultrasonic and conventional method was studied to ensure that the heating process can eliminate the crystals.

The aim of this experiment was to identify the most effective heating process by comparing between heating following Dyce's method and heating with ultrasonic

treatment from developed method. Ultrasonic treatment was carried out with an ultrasonic bath with 45 kHz (Stasiak and Dolatowski, 2007), power 100 Watt. Heating temperature was used from the result from part 3.1.1 and treated with honey samples of ~100 g. The temperature profile and the effect of ultrasonic treatment on the hydroxymethylfurfural concentration (HMF) and color were studied and determined in comparison with Dyce's method. Finally, the least heating time and the best quality of heat-treated honey samples was further select in the suitable heating process of creamed honey.

### 3.2.3 To determine the optimal cooling condition

The rate of cooling affects the amount of crystalline mass, the crystal habit, and result in the texture of the product. It is important to ensure that process are designed to the desired crystallization temperature (Myerson, 2002). After heating the liquid honey, the cooling rate between slow and rapid were study in this section. The cooling in chilled water at temperature range of 3 - 5°C and 10 - 15°C were comparing in different cooling rate. The cooling rate was calculated from Eq. (39) and analyzed the result by temperature profile and hardness analysis.

$$\text{Cooling rate } (^{\circ}\text{C} / \text{min}) = \frac{T_{\text{max,honey}} (^{\circ}\text{C}) - T_{\text{after cooling,honey}} (^{\circ}\text{C})}{\text{Total time}(\text{min})} \quad \text{Eq. (36)}$$

The cooling time will compare between Dyce's method and developed method for further select into the suitable process of creamed honey product.

### 3.2.4 To determine the optimal amount of seed addition and speed of agitation

From the result of 3.2.2 to 3.2.3, the seeding addition is the next step and it is the important factor which will impact with final product texture. The less amount of starter, it may not produce a finely crystallized honey, if the over amount of seeding, it may excessively use and may obtain a rigid or hard texture in creamed honey product.

- Three researchers was used different quantity of seed starter in seeding addition step (Dyce, 1931a; Elhamid and Abou-Shaara, 2016; Intipunya and Metanee, 2012) and (Dyce, 1931a) recommend in the range of seeding addition in 5 – 10% (w/w) for obtain a finely crystallized honey (D'Arcy, 2007). However, the honey composition such as sugar and water content, the type of honey, and the temperature during seeding may influence with the amount of seeding addition. Thus, the optimal amount of seeding addition for produce Thai creamed honey will investigate in this part.

The result from section 3.1.2 will further study in this section, the seeding addition was used into three different amount by the percentage of seeding starter (w/w) with liquid honey (5%, 7.5%, and 10%) (D'Arcy, 2007) on the texture (firmness and adhesiveness) (Shinn and Wang, 1990). The honey without seed addition is the control sample. Samples were vigorous mixing to thoroughly mix between seed and liquid honey. The hardness value is the main indicator to decision for selecting the suitable amount of seed addition. To produce a laboratory creamed honey has a similar texture to the Dyce and commercial creamed honey product, the target of the hardness value should be set. Moreover, the visual observation and the type of creamed texture will observe and evaluate in everyday, the type of creamed texture was declared in score from 1 to 7 as hard to very fine texture. The relationship between grade number and type of creamed texture will present as Table 13.

**Table 13** Definition of creamed honey texture

Score	Type of Creamed texture	Score	Type of Creamed texture
1	Hard	5	Medium
2	Very coarse	6	Fine
3	Coarse	7	Very fine
4	Medium coarse		

**Source:** adapted from D'Arcy (2007)

The G/W ratio of each honey samples was analyzed for classifying the suitable amount of seed addition. Finally, the solution of this part should be concluded in the suitable amount of seed addition in each honey type.

After seed honey was added into the suitable amount, the agitation speed should be studied for providing the sufficient speed to promote maximum nucleation in the shortest time. Mechanical energy input enhances the nucleation process. Intensity of agitation or comparing between lower (100 - 300 rpm) which is represent the manually mixing of Dyce's method and rapid agitation (1,000 – 1,300 rpm) was presented in this part and resulted in the data of texture profile and appearance of creamed honey.

### **3.2.5 To study the effect of ultrasonic treatment on post-treatment**

Applying ultrasonic treatment to honey has two main reasons including, reducing of micro-organisms and modifying crystallized honey appearance (Mortaş, 2013). After the honey was pre-treated by ultrasonic, the existing crystals should all eliminate and presented in clearer appearance or occurred in homogeneous solution. Then, the crystal forming will continue after seed addition and will further produce a fine texture during store in chilled temperature. From Dyce process (D'Arcy, 2007; Dyce, 1931a,b), the crystallization will continue in crystal nucleation after seed addition. Normally, the crystal growth and nucleation will occur during thoroughly mixing and keep in cold storage. Therefore, to reduce the time in this step, ultrasonic treatment will use to reduce the metastable zone width.

Creamed honey samples were prepared, add seed starter and mixing following previous result. The mixed honey sample will post-treat with ultrasonic treatment in cooling water which maintain temperature range of 3 - 5°C for controlling temperature of mixed honey not over than 20°C, the control treatment is the mixed honey sample without ultrasonic treatment (Hyo, N.K. and Suslick, K.S., 2018). The ultrasonic treatment was carried out by using input power of 0.33 Watt/g sample and frequency at 40 kHz (Basmaci, 2010; Chaikham et al., 2016; D'Arcy, 2007;

Kabbani et al., 2011; Önür et al., 2018; Phawatwiangnak and Intipunya, 2013; Quintero-Lira et al., 2016; Stasiak and Dolatowski, 2007; Thrasyvoulou et al., 1994).

### **3.2.6 To investigate the storage condition and product shelf-life**

1) To determine the optimal time for keeping in chilled temperature

After the honey was treated with ultrasonic, added seed starter and enhance the texture with ultrasonic treatment, the creamed honey was filled into bottles, cover closed and kept in low temperature or refrigerator (temperature of 10 - 15°C) for obtained a fine textured creamed honey (D'Arcy, 2007). However, the chilled storage time may be differed following the honey type, the suitable storage time is detected from the hardness value. The suitable storage time will declare from the hardness value closed with the target, the spreadability of creamed honey product by visual observation.

2) To determine the conditioning condition

After the creamed honey kept in chilled temperature, the texture of product will firm or tight, to produce the spreadability of creamed honey, the conditioning in low temperature or temperature at 18-22°C should be study in next. Creamed honey samples were place at low temperature and check the spread of creamy by scoop the creamed honey out and spread it on a glass plate. Observe by visual until the spreadability of creamed honey is similar with the commercial product.

3) To determine the product shelf-life

The consistency is the texture parameter to guarantee the quality of product during provide on shelf or the product should be maintaining all quality of the product until send to the consumer. Like a creamed honey product, the time until the creamy texture return into the liquid form is the indicator to guarantee the product shelf-life. We divided the study into two parts including; place at low temperature (18-22°C) and room temperature (28-30°C), the depth of liquid will measure and calculate to the percentage of the consistency as in Eq. (37). The product shelf-life will guarantee by % of consistency should not be less than 95%.



$$\frac{\text{Total height of creamed (mm)} - \text{depth of liquid layer (mm)}}{\text{Total height of creamed contain (mm)}} \times 100 \quad \text{Eq. (37)}$$

To confirm the product variation during storage and to study the relation between thermal properties and product appearance, differential scanning calorimetry (DSC) study in this part. The shelf-life of creamed honey where further crystallization is inhibited directly involves the induction time for nucleation at the storage conditions. However, the product quality should not deteriorate greatly, if crystallization continues under optimal controlled conditions after packaging (Myerson, 2002). In the present study, the creamed honey sample was stored at room temperature (25 - 30°C) and differential scanning calorimetry (DSC) was used the technique for monitoring in different storage condition.

A Mettler-Toledo DSC 1 Module with the STARe software (Mettler-Toledo) was used to follow the thermal behavior of honey samples. Indium and zinc standards were used to calibrate the differential scanning calorimeter, and the measuring range was extended to -65°C by a cooling Intra Cooler system. A calorimetric heat flow was used to obtain quantitative and qualitative data concerning the net heat changes produced by carbohydrates during their heating. Samples of ~10 mg of honey were placed in weighed aluminum DSC hermetic pans, and as a reference, an empty crucible was simultaneously measured. The experiments were conducted from -65 to 200°C to obtain the complete thermal behavior of pure honey and creamed honey from low temperature to high temperature. Various start temperatures and heating rates were applied to the samples following literature reports (Cordella *et al.*, 2002; Cordella *et al.*, 2003; Tomaszewska-Gras *et al.*, 2015). After we evaluated the effect in the range of 2-50°C/min, we selected a heating rate of 10°C/min. The calorimetric response improved this heating rate without a decrease in accuracy, reduced the analysis time, and decreased the risk of sample degradation. Three DSC runs were performed to determine various glass transition temperatures ( $T_g$ ) and the melting behavior of the

samples at higher temperatures to calculate the enthalpy of crystal melting ( $\Delta H_m, J/g$ ) and enthalpy of sugar fusion ( $\Delta H_f, J/g$ ).

### 3.2.7 To establish the developed method for creamed honey production

The aim of this part was to compare the efficiency of the process from total processing time between this research method and Dyce's method.

The comparison of the processing time between Dyce's method and developed method will study and calculate into percentage of processing time reduction by Eq. (38).

$$\text{Percentage of processing time reduction} = \frac{\text{Developed processing time}}{\text{Original processing time}} \times 100 \quad \text{Eq.(38)}$$

### 3.3 To study the crystallization behavior and improve the model to explain the crystallization of creamed honey

The Avrami equation (Avrami, 1939) was applied and used to describe the model crystallization kinetics of various sugar and honey (Dettori et al., 2018) from thermal analysis, but has not applied with the absorbance value at 660 nm. Conforti (2006) and Lupano (1997) reported that turbidity measurement as the absorbance at 660 nm can be taken as an indicator of honey granulation. The increase of turbidity value indicates the presence of more honey crystals. There is a lack of study concerning honey crystallization modeling, both for monitoring the crystallization kinetic and further applying for the design of creamed honey process. Therefore, the aim of this part was trying to describe the crystallization behavior and improve the mathematical model with honey by induced with glucose addition for further apply in design of creamed honey maker.

### 3.4 To conceptually design the prototype for creamed honey machine and study the economic analysis.

Process design refers to the design of food processes and manufacturing methods including process flow sheets, design of processing and control equipment,

and economic evaluation of the process (Saravacos and Kostaropoulos, 2016). The development of food process design is based on the principles of food science and technology, chemical engineering, and on the practical experience of food engineers, and food technologists. Since the research data and development of food process design of creamed honey production is limited, it is necessary to study and applied the theory for design model prototype of creamed honey machine and until evaluate the economic analysis. Throughout the designing of the creamed honey process, as discuss from the first, estimation of the cost of equipment and relevant costs, such as the operation costs and hygienic equipment costs. Capital cost estimates are prepared and combined with the process operating costs and other expenses to determine the profitability of a proposal venture. Total capital investment cost is divided into direct and indirect cost. The direct cost is the summation of equipment and setting. The indirect cost consists of engineering and supervision, contingency and facilities. The overall framework divided into two main groups namely 4.4.1) Food innovation concept design, and 4.4.2) Economic analysis.

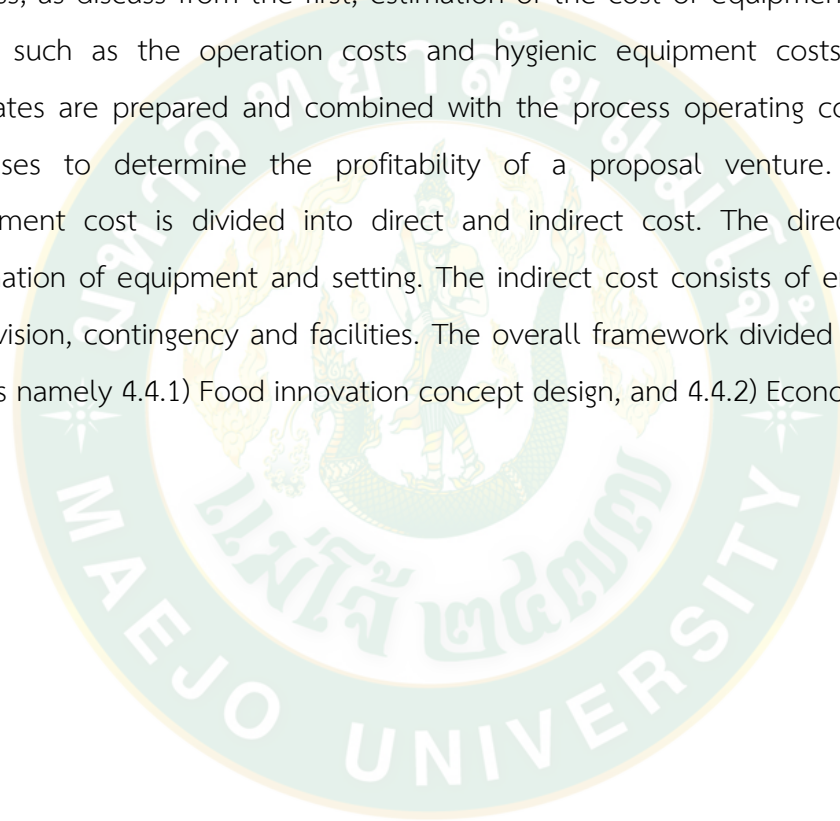

## CHAPTER 4

### RESULT AND DISCUSSION

#### **4.1 The possibility to produce creamed honey product from various types of honey in Thailand**

The crystallization process is impacted by glucose/water ratio (G/W ratio), fructose/glucose ratio (F/G ratio), pasteurization and storage temperature (Elhamid and Abou-Shaara, 2016)

Different types of honey will crystallize at different rates. Some honey crystallizes within a few weeks after extraction from the combs, whereas others remain liquid for months or years. The following factors influence the speed of crystallization. The time for taking the honey to crystallize depends mostly on the ratio of fructose to glucose and the glucose to water ratio. The tendency of honey crystallization depends on its composition and moisture content. Honey with G/W ratios more than 2.16 are presence in rapid-granulating honeys. If we want to obtain the finer texture in creamed honey product, it should prepare from the more rapid honey crystallization.

Regarding to there were information about modified of physicochemical properties in liquid honey for induced fastest crystallization, and there was less information how to improve creamed honey production from many types of Thai liquid honey. Thus, the aim of this objective is investigating on the possibility to produce the creamed honey from various types of honey with best texture, due to several research for glucose and water content adjusting had proposed the below information.

##### **4.1.1 The relation between physicochemical properties and crystallization behavior of various types honey in Thailand**

Five types honey from various brands (7 samples) in Thailand were observed by visual observation and analyzed for carbohydrates (fructose and glucose), and moisture content before place for observe the natural crystallization. From the visual

observation and reviewed the information in each honey type, we found that the details following;

1) Sunflower honey (*Helianthus annuus* Linn.) contained little sucrose and therefore quickly crystallized. After crystallization, honey is like melted butter and hard to pour it in consumer packaging. Because sunflower honey crystallizes quickly, becoming soft and easy to spread, it is often consumed in its crystallized state.

2) Longan blossom honey or longan honey (*Dimocarpus longan* Lour.) is a brown aroma, taste, sweeter than others honey. The color is darker than another honey type and overall appearance does not change with temperature, even leaving it in the low temperature. Longan is usually harvested during February to April and mainly cultivated in the Chiang Mai and Lamphun provinces of Northern Thailand (Wanjai et al., 2012). The sum of fructose and glucose concentrations in longan honey was higher than 60% (w/w), this may be caused by the flower origin of nectar.

3) Lychee honey is a very light colored monofloral honey, amber color and taste is sweet. It contains 70% lychee pollen and 30% others kind of pollen. It has a very delicate flavor with a taste slightly reminiscent of roses. It will crystallize when it is cold or when put in the refrigerator, but its granulation is quite thin. The honey is harvested from September until November.

4) Wildflower honey or wild honey, also known as polyfloral honey, is derived from the nectar of numerous species of flowers or blossoms. The taste, aroma and flavor will vary from season to season, depending on which flowers are dominant at the time the nectar is collected. The color of wild honey in Thailand is dark color similar with longan honey and it can place in room temperature without any change of appearance and color for a long period time.

5) Bitter Bush honey or Sabsua honey has medicinal properties. The color is dark brown and present a strong aroma and taste. It a rare item of honey in Thailand, so it is a type of honey that is not very popular in Thailand.

As above mention, so the formation of honey crystals was differed following the honey compositions and type. Moreover, the time of honey crystallization until fully crystallization and crystallization indices will different also, the result was shown in Table 14.

**Table 14** Moisture content and sugar composition (%) of Thai honey

Type of honey	G	F	W	G/W ratio	F/G ratio	Crystallization index
CF	39.55	32.11	21.02	1.88	0.81	slow
LG-L	32.12	39.69	21.20	1.52	1.24	non
LG-SP	31.96	42.11	16.87	1.53	1.32	non
LG-LT	32.85	43.75	20.25	1.62	1.33	non
LC	42.49	39.62	19.14	2.22	0.93	rapid
SU	39.52	40.26	18.43	2.14	1.02	rapid
WD	38.25	44.19	18.25	2.09	1.16	non

Remark: - rapid crystallization: complete within 1 month, medium: 1-6 month, slow: > 6 month, non: > 1 year

- G = glucose content (g/100 g), F = fructose content (g/100g), W = water content (g/100g)

- CF = coffee honey, LG-L = longan honey from lumphun province, LG-SP = longan honey from Supha farm, LG-LT = longan honey from Luang Thong, LC = lychee honey, SU = sunflower honey, WD = wild honey

From Table 14, the result shown that longan honey presented different moisture content in each brand, the lowest moisture content found in Supha Bee farm, 16.87%. Although, all brands of longan honey are differed in moisture content, but G/W ratio was less than 1.70 which are represent in non-granulating honey by 1.52, 1.53 and 1.62 in Lumphun, Supha Bee farm and Luang Thong, respectively. Not only longan honey presented in hard to crystallize during storage but also in wild honey. There were two honey types in rapid crystallization including sunflower and lychee honey. Glucose and fructose in sunflower honey are approximately 39.52% and 40.26%, respectively, so it shown in F/G ratio is equal 1.02 which is less than 1.11. In several reports, a value of F/G of < 1.11 has been associated with fast granulating honey while a value of 1.33 or more indicates non-granulation (Bhandari et al., 1999).

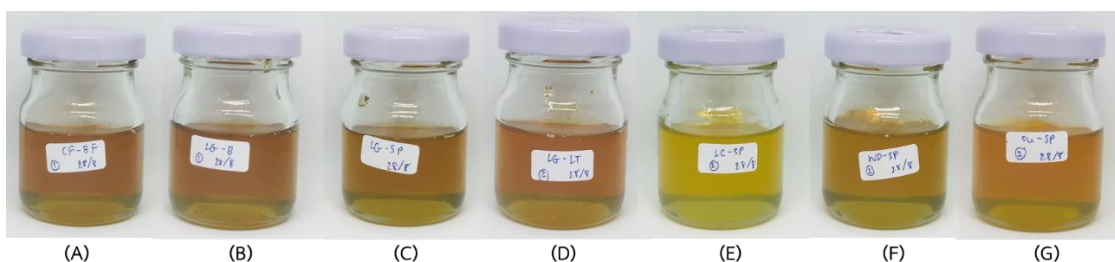

**Figure 16** Appearance of liquid Thai honey;

(A) coffee honey, (B) longan honey from lumphun province, (C) longan honey from Supha farm, (D) longan honey of Luang Thong brand, (E) lychee honey, (F) wild honey, (G) sunflower honey

The appearance of honeys before keeping in refrigerator shown in Figure 16 and all honeys presented in clear liquid honey. When the storage time increased to 14 days, each variety of honey crystallized differently. Lychee and sunflower honey produced some crystals during keeping in chilled temperature (10-14°C), while longan and wild honey are not found any crystals in bottle for more than 1 year (Figure 17).

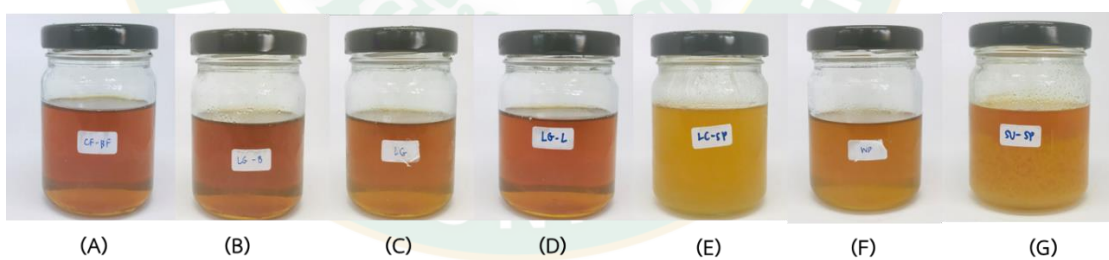

**Figure 17** Honey appearance during keeping chilled temperature (10-14°C),

in 14 days; (A) coffee honey, (B) longan honey from lumphun province, (C) longan honey from Supha farm, (D) longan honey of Luang Thong brand, (E) lychee honey, (F) wild honey, (G) sunflower honey

Regarding some of honey never crystallize, some crystallize very low, some very quickly, some have fine crystals, and some have bigger crystal grains. This has created a handling and processing uncertainties for the creamed honey processors. In

addition, crystallization of honey affects the quality of the final product and is an undesirable property in handling and processing. The honey properties should be study before design the suitable process to produce creamed honey product. Therefore, we selected sunflower honey for further develop in creamed honey production, the reason came from the light-yellow color and the rapid crystallization will present the small crystal which is enhanced to produce a fine and smooth texture in creamed honey.

However, in case of non or slow granulating honey like longan and wild honey are specific study by control of crystallization process. Regarding the glucose per water ratio (G/W ratio) is the parameter to classify the crystallization behavior, so the method to reduce the moisture content or increase the glucose content in liquid honey. There were two method to study in part 4.1.2 including dehydration method to reducing the moisture content and glucose powder adding for increasing the glucose content.

#### **4.1.2 Effect of moisture and glucose content to the crystallization behavior of honey**

##### **1) Dehydration method**

Three researchers were studied the influence parameters on crystallization behavior (Srinual, 2007) and investigated the effect of glucose concentration on crystallization time by adding by glucose powder into liquid honey, reduce moisture content and stored in low temperature (Elhamid and Abou-Shaara, 2016; Intipunya and Metanee, 2012). But there was only in some types of honey in Thailand and no have the method that trying to improve for further used in creamed honey production, also this research will study the effect of honey properties on crystallization behavior and study the possibility method for producing creamed honey product from various types in Thailand.

The average weight of sample is  $5.257 \pm 0.11$  g and was dried in moisture can. The sample contained in moisture can with height and diameter of 1.0 and 5.0 cm,



respectively. Longan honey contained moisture content in  $19.50 \pm 0.05\%$  wet basis and presented water activity (aw) equal  $0.56 \pm 0.01$ . Glucose and fructose in longan honey were  $31.31 \pm 1.03\%$  and  $42.56 \pm 2.14\%$ , respectively, so it is categorized in non-granulating honey. From the high level of moisture content and less amount of glucose, so it is cannot produce the crystal during storage, moreover, the reason from the glucose per water ratio (G/W ratio) is 1.61 which is less than 1.70 and presented the fructose per glucose ratio (F/G ratio) is 1.36 (higher than 1.33) (Bhandari et al., 1999). If we can adjust the G/W ratio in raw material of creamed honey production, it may easy to control all of step in the process. One method to reduce the water content in honey is the dehydration process by heating in low temperature for preserve the honey quality. Hot air oven and vacuum far-infrared dryer were compared to studying in this part.

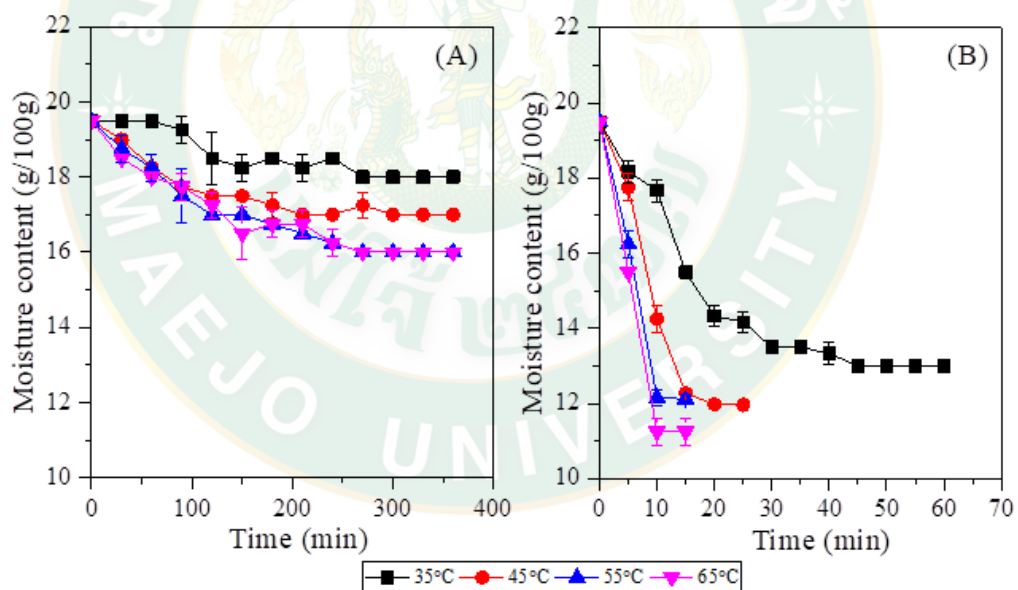

**Figure 18** The dehydration curve of longan honey in (A) Hot air oven (B) Vacuum far-infrared dryer; at different temperature

Four levels of dehydration temperature were including 35, 45, 55 and 65°C. The dehydration by using vacuum far-infrared dryer were carried out under the conditions of pressures in drying chamber at 5 kPa (Intipunya and Metanee, 2012; Kunjet et al., 2017). The results showed that the dehydration with vacuum-infrared

dryer could be reduce the moisture content from  $19.50\% \pm 0.25$  (wet basis) to  $11.25\% - 13.00\%$  (wet basis) or could decrease the moisture content for  $33.33 - 42.31\%$  within 1 hour. The curve of moisture content in vacuum far-infrared dryer shown in rapidly decrease in all conditions, as shown in Figure 18(B), while there were slowly decrease in dehydration by hot air oven and take more time for over 6 hours, as shown in Figure 18(A). The moisture content decreased only  $7.69 - 17.95\%$  from initial value by using the hot air drying. Therefore, the G/W ratio of longan honey could not increase reach to 2.16 which is the range of fast granulating honey, as in Figure 19(A).

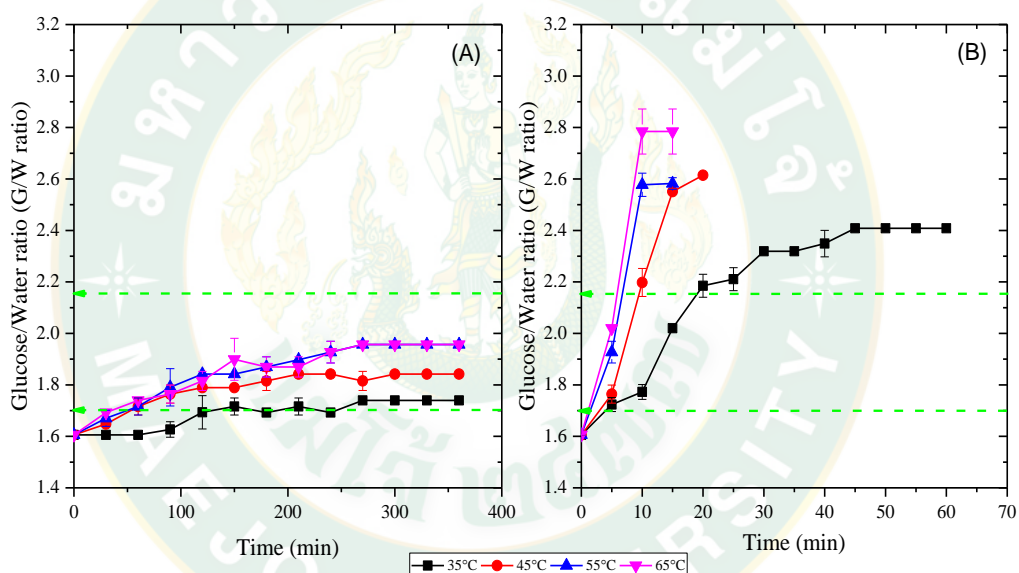

**Figure 19** G/W ratio variation with dehydration time of longan honey by (A) Hot air oven (B) Vacuum far-infrared dryer at different temperature

The G/W ratio of longan honey increased from 1.61 to 2.16 in every condition of dehydration by vacuum far-infrared dryer. The shortest time presented in temperature of  $55^{\circ}\text{C}$  and  $65^{\circ}\text{C}$ .  $\Delta G/W$  ratio obtained in 2.58 and 2.78 in  $55^{\circ}\text{C}$  and  $65^{\circ}\text{C}$ , respectively. If the value of G/W ratio reached to 2.16, the liquid honey can present in the rapid crystallization behavior. However, heating is the important processing step in honey production because it directly affects the quality of honey especially in color and appearance. The water activity and colour measurement of

longan honey comparing between dehydration by vacuum far-infrared dryer and hot air oven were shown in Table 15.

**Table 15** Colour and water activity ( $a_w$ ) analysis of longan honey before and after dehydration by vacuum far-infrared and hot air oven at different condition

Dehydration system	Condition (Temperature and time)	Colour			Water activity ( $a_w$ )
		L*	a*	b*	
Control		3.56±0.17 <sup>c</sup>	0.71±0.84 <sup>b</sup>	-0.77±0.39 <sup>c</sup>	0.562±0.009 <sup>c</sup>
Vacuum far-infrared dryer	35°C, 60 min	1.87±0.16 <sup>b</sup>	-0.79±0.82 <sup>a</sup>	0.69±0.87 <sup>d</sup>	0.514±0.002 <sup>c</sup>
	45°C, 20 min	2.85±0.14 <sup>c</sup>	-0.31±0.27 <sup>a</sup>	-1.14±0.47 <sup>c</sup>	0.372±0.003 <sup>b</sup>
	55°C, 10 min	3.51±0.32 <sup>c</sup>	-0.56±0.22 <sup>a</sup>	-3.45±0.56 <sup>b</sup>	0.380±0.004 <sup>b</sup>
	65°C, 10 min	1.33±0.03 <sup>a</sup>	-0.40±0.28 <sup>a</sup>	-7.21±0.07 <sup>a</sup>	0.352±0.002 <sup>a</sup>
Hot air oven	35°C, 360 min	3.47±0.05 <sup>c</sup>	1.17±0.62 <sup>b</sup>	1.57±0.35 <sup>a</sup>	0.365±0.001 <sup>d</sup>
	45°C, 360 min	3.04±0.02 <sup>a</sup>	1.21±0.72 <sup>b</sup>	1.46±0.23 <sup>a</sup>	0.352±0.001 <sup>b</sup>
	55°C, 360 min	3.17±0.09 <sup>ab</sup>	1.18±0.40 <sup>b</sup>	0.44±0.23 <sup>b</sup>	0.348±0.001 <sup>a</sup>
	65°C, 360 min	3.27±0.21 <sup>b</sup>	0.78±0.51 <sup>b</sup>	1.23±0.61 <sup>a</sup>	0.351±0.002 <sup>b</sup>

Note: data are represented as mean±S.D. of three replicates (n=3).

From Table 15, the brightness ( $L^*$ ) of longan honey was decreased or presented darker colour when it was treated with vacuum far-infrared dryer in every conditions. Heating with low temperature for preserve the honey quality and take the shortest time will be better choice for use in raw material preparation for creamed honey production. Because the heating above 60°C will affects the quality and causes protein denaturation and deactivation of several enzymes which are mainly responsible for its functional behavior (Janghu et al., 2017). That is why minimal processing techniques or heating treatment in low temperature is very important and study for applying in honey dehydration. If we want to dehydrate and heat the honey for any purpose, the heating temperature should not over than 60°C. From this result, the temperature of 55°C may suitable for further consider in creamed honey production. However, the suitable temperature and time should be determined by concerning the final product quality in the main point.

## 2) Glucose powder addition to increase the glucose content

Regarding to the quality of granulated honey or creamed honey, from the standpoint of human taste, depends on size of crystals, and honey with large coarse crystallization is inferior to that with small crystals. Moreover, the small crystals was obtained from only rapid or fast crystallization and glucose content should present to about 34% which is readily crystallized and forms the solid phase of creamed honey (Dyce, 1931a). Sunflower and longan honey are the honey samples in this part because they composed of different crystallization behavior and properties.

**Table 16** Biochemical compositions (g/100 g) of honey samples

Honey Property	Honey type	
	Sunflower honey	Longan honey
Moisture (% wet basis)	18.37 ± 0.09	19.70 ± 0.31
Total solids (%w/w)	80.06 ± 0.18	82.80 ± 0.17
Water activity	0.616 ± 0.002	0.570 ± 0.004
Fructose	40.15 ± 0.57	42.56 ± 2.14
Glucose	39.01 ± 0.51	31.31 ± 1.03
Sucrose	0.39 ± 0.05	0.76 ± 0.03
Maltose	1.50 ± 0.04	0.57 ± 0.04
Lactose	Not Detected	Not Detected
F/G ratio	1.03	1.36
G/W ratio	2.12	1.59

Note: data are represented as mean±S.D. of three replicates (n=3).

Both sunflower and longan honey were clear liquid; in which crystals were not present before the addition of glucose. The biochemical compositions of its are shown in Table 16 with a corresponding glucose concentration of 39.01% and 31.31%, respectively. The water percentage of sunflower and longan honey were 18.37% and 19.70% wet basis, respectively. Thus, the resulting G/W ratio of longan honey is 1.59, which is less than 1.70 and was categorized in non-granulating honey

(Bhandari et al., 1999). Moreover, the F/G ratio of sunflower honey was less than 1.14 (White Jr, 1975), where rapid crystallization was found; while F/G ratio of longan honey was 1.36, relatively higher than optimized value of 1.33 and confirm to categorize as slow or non-granulating honey. Regarding the tendency of honey, crystallization depends on its composition and moisture content. Therefore, sunflower and longan honey were selected in this study to represent honey with rapid and non-crystallization behaviors, respectively.

The absorbance measurement during storage was studied in order to explain the crystallization behavior. Glucose powder was added for inducing the crystallization because different characterizations due to glucose content can be altered by adding glucose powder (Lupano, 1997).

More granulated honey resulted in greater turbidity values. An increase in the absorbance intensity at 660 nm was considered valid to determine the extension of honey granulation (Lupano, 1997). Liquid of sunflower and longan honey, which were stored at chilling temperature, were found to have increasing turbidity interpreted from the absorbance at 660 nm.

From different crystallization behaviors (Figure 20), it was showed that the absorbance at 660 nm of honey stored at 10-15°C without glucose addition (control-SU and control-LG) is a function of storage time. However, it has shown different characteristics, and the absorbance increased rapidly in sunflower honey until the absorbance value reached 3.0 (23 days). Moreover, the appearance was shown in light yellow color and found overall turbidity in the sample. The absorbance of longan honey was slowly increased, and no crystals were found for more than 120 days, so it is slow or non-granulating honey. Therefore, the absorbance at 660 nm was correlated with the overall appearance of honey during storage in chilled temperature.

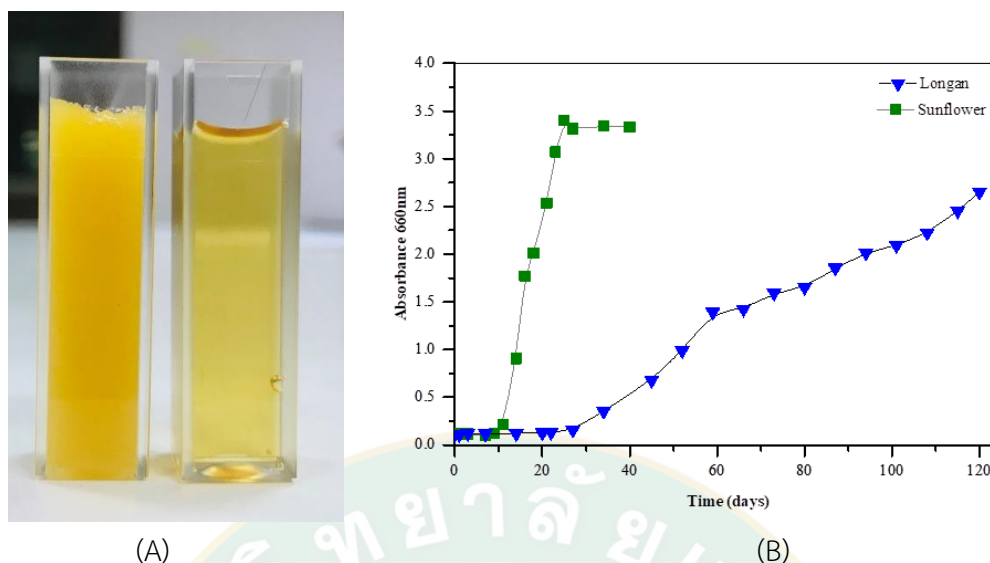

**Figure 20** Natural crystallization of sunflower and longan honey

(keeping in chilled temperature; 10-14°C); (A) honey appearance in cuvette in day 23  
 (B) Absorbance at 660 nm as a function of storage time

A correlation between the fructose/glucose (F/G) ratio and crystallization behavior was also obtained. Sunflower honey had a low F/G ratio (1.03) which equal or less than 1.14, which resulted in fast or rapid crystallization (Tosi *et al.*, 2004). It also presented rapidly increased absorbance at 660 nm. While F/G ratio of longan honey is higher (1.36) and no crystals are found for more than six months, it means no tendency or slow to crystallize during storage, except that the honey compositions have change. Thus, the absorbance curve presented by the crystallization behavior of longan honey was slower than that of sunflower honey. Laos *et al.* (2011) reported on the correlation of F/G ratio and the crystallization time; a higher F/G ratio presented longer crystallization time in eleven Estonian honey samples. These results are similar to Gleiter *et al.* (2006) mentioned that the required time for honey to crystallize depends on the F/G ratio.

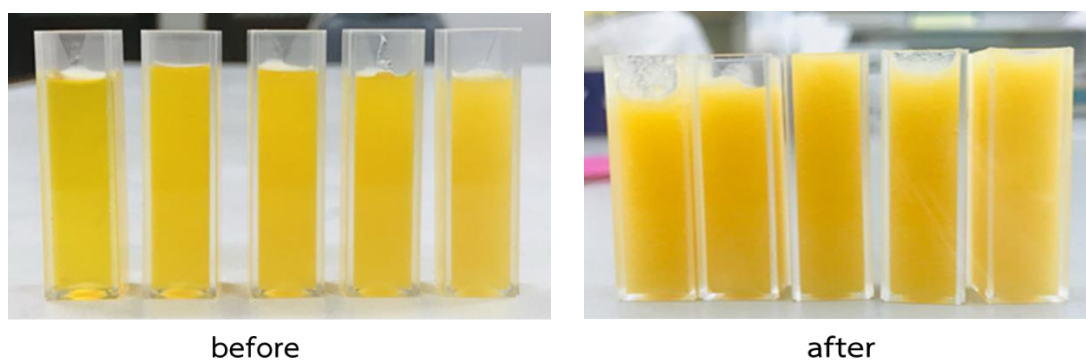

(A) Sunflower honey

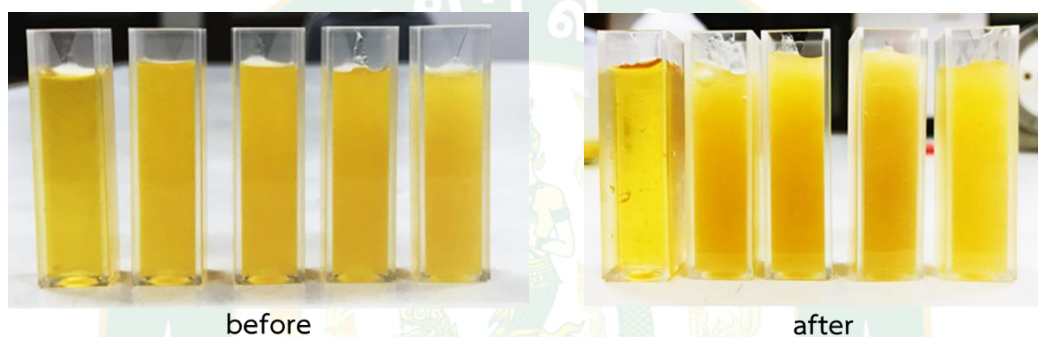

(B) Longan honey

**Figure 21** Appearance in cuvette of sunflower and longan honey when induced with glucose addition

The turbidity of honey increased, when the crystallization time increased as shown in Figure 21. The intensity of absorbance at 660 nm has been carried out to monitor increases of glucose crystal in honey samples during storage at chilling temperature. The results showed that we could accelerate crystallization by adding glucose powder into both samples (Figure 22). When absorbance or turbidity was increased, the crystallization rate increased with non-linear characteristics. It rapidly increased in the initial phase. At close to full crystallization, the curve continued, particularly in sunflower honey. These results are consistent with a study by Lupano (1997).

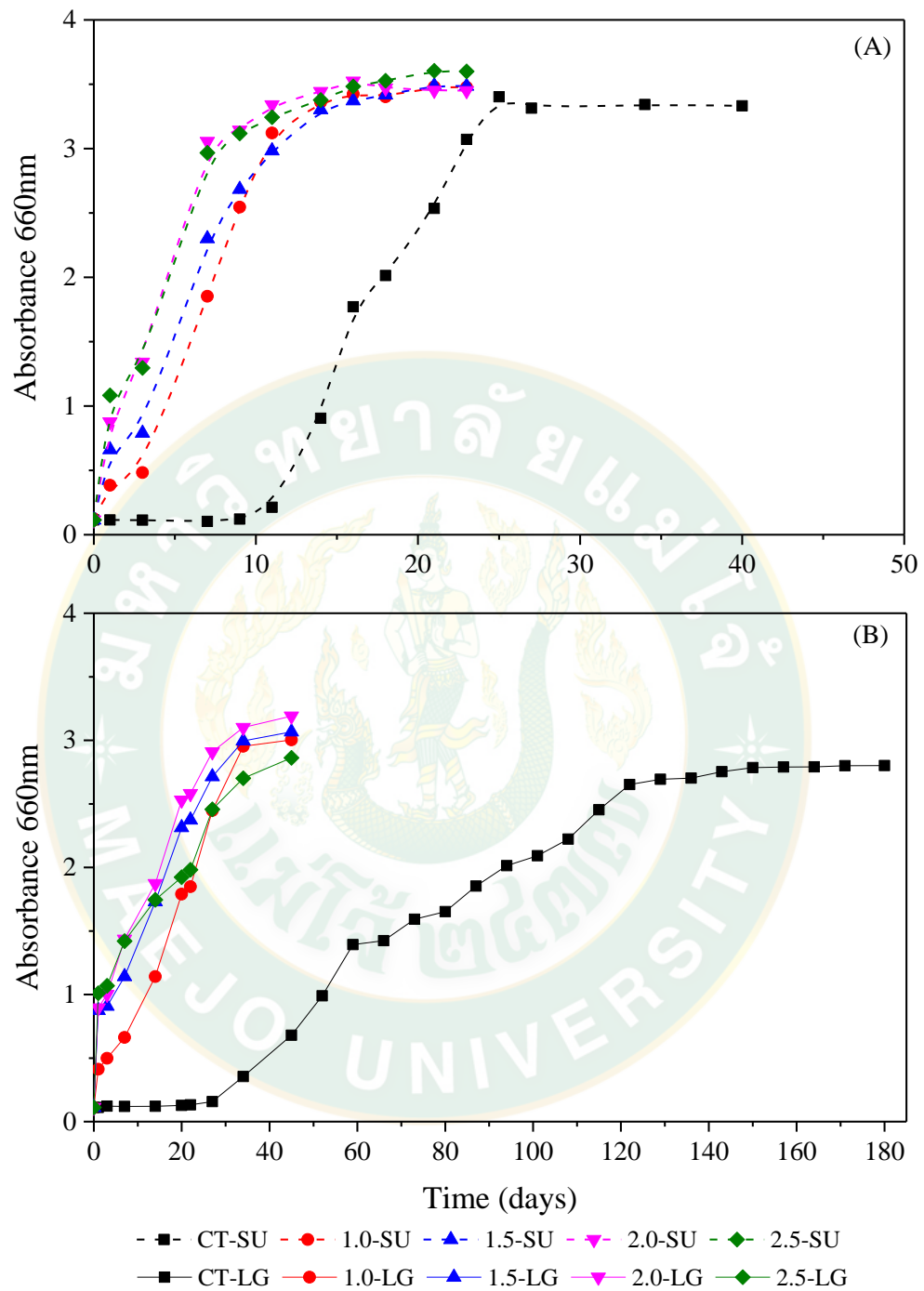

**Figure 22** Absorbance at 660 nm of, (A) natural crystallization behavior, and (B) the crystallization behavior was induced with glucose addition of sunflower.

Crystallization times of sunflower and longan honey were 39% and 81% faster, respectively, after 1.0% (w/w) was added. 2.0%(w/w) glucose allowed the



highest crystallization rate, 70 and 88% were shown to be faster in sunflower and longan honey, respectively (Table 17).

**Table 17** Full crystallization time and the absorbance value of crystallized honey resulted from adding glucose powder; 1.0, 1.5, 2.0, and 2.5 (%w/w) to liquid sunflower and longan honey.

Sample	Treatment	Crystallization time (days)	Absorbance value at 660 nm	
			Day 0	At full crystallization
Sunflower honey	Control	23	0.115 ± 0.000 <sup>a</sup>	3.072 ± 0.047 <sup>a</sup>
	1.0%	14	0.385 ± 0.001 <sup>b</sup>	3.360 ± 0.008 <sup>b</sup>
	1.5%	14	0.661 ± 0.002 <sup>c</sup>	3.303 ± 0.008 <sup>c</sup>
	2.0%	7	0.877 ± 0.008 <sup>d</sup>	3.056 ± 0.005 <sup>a</sup>
	2.5%	9	1.082 ± 0.002 <sup>e</sup>	3.118 ± 0.007 <sup>d</sup>
Longan honey	Control	>120	0.111 ± 0.001 <sup>a</sup>	2.454 ± 0.002 <sup>a</sup>
	1.0%	34	0.412 ± 0.002 <sup>b</sup>	2.953 ± 0.004 <sup>b</sup>
	1.5%	34	0.878 ± 0.003 <sup>c</sup>	2.996 ± 0.002 <sup>c</sup>
	2.0%	22	0.890 ± 0.025 <sup>c</sup>	2.580 ± 0.001 <sup>d</sup>
	2.5%	27	1.010 ± 0.013 <sup>d</sup>	2.456 ± 0.003 <sup>e</sup>

Note: data are represented as mean±S.D. of three replicates (n=3). Means followed by the different letter are significantly different between mean values (p<0.05).

Longan honey, which is naturally non-crystallized honey, reached full crystallization within 22 days after 2.0%(w/w) was added, while sunflower honey took only 7 days. These findings differed from the study by Elhamid et al. (2016) who reported that high glucose content leads to high crystallization. The fastest crystallization process (27 days) happened when 1.2, 1.8, or 2.4%(w/w) powder glucose was added into clover and cotton honey. It was faster than of 0.3% (66 days) and 0.6% (56 days). Moreover, in a study by Intipunya and Metanee (2012) glucose powder was used successfully at 1:1.3 of fructose/glucose ratio and storage of 10°C to obtain crystallized sunflower honey and they found that the crystallization time

was longer in the ratio of fructose/glucose at 1:1.1. The fastest crystallization time was found in sample with the highest concentration of glucose or 2.4%(w/w). Such different results might be due to the different honey types, geographical areas, and floral sources, which potentially leads to different crystallization behaviors and the rate of crystallization.

Not only was the smooth texture as indicator of consumer acceptance, but the color of the final product in creamed honey was the main parameter. The honey color was changed during crystallization process; good creamed honey should be light yellow in color, which results from full fine crystals.

Figure 23 reported the values of brightness ( $L^*$ ), hue angle, ( $h^o$ ) and Whiteness Index ( $WI$ ) of sunflower and longan honey samples from initial time until reaching full crystallization under cooling storage. Before being induced by glucose powder, sunflower honey was clear to light yellow or golden colored, while longan honey presented as a darker yellow color. During the crystallization process, brightness ( $L^*$ ) and Whiteness Index ( $WI$ ) values increased in most of the samples, but changed rapidly in sunflower honey. The color of longan honey changed slightly during storage and was similar to crystallization behavior.

Hue angle ( $h^o$ ) was decreased until it reached fully crystallization but was not clearly changed in longan honey samples (Figure 23(E)). This is similar to the results of Dettori et al. (2018), who reported that  $h^o$  of fast crystallization honey sample showed low values because it contained 100% of sunflower honey which was composed of high yellow and red components, which in turn gave a darker tint or lower  $h^o$  when compared to slow and medium crystallization samples. However, the color was due to the appearance of glucose crystals reflecting the light, so promoting the increase of brightness and a reduction of the yellow component resulted in a degree of the  $h^o$  in all samples.

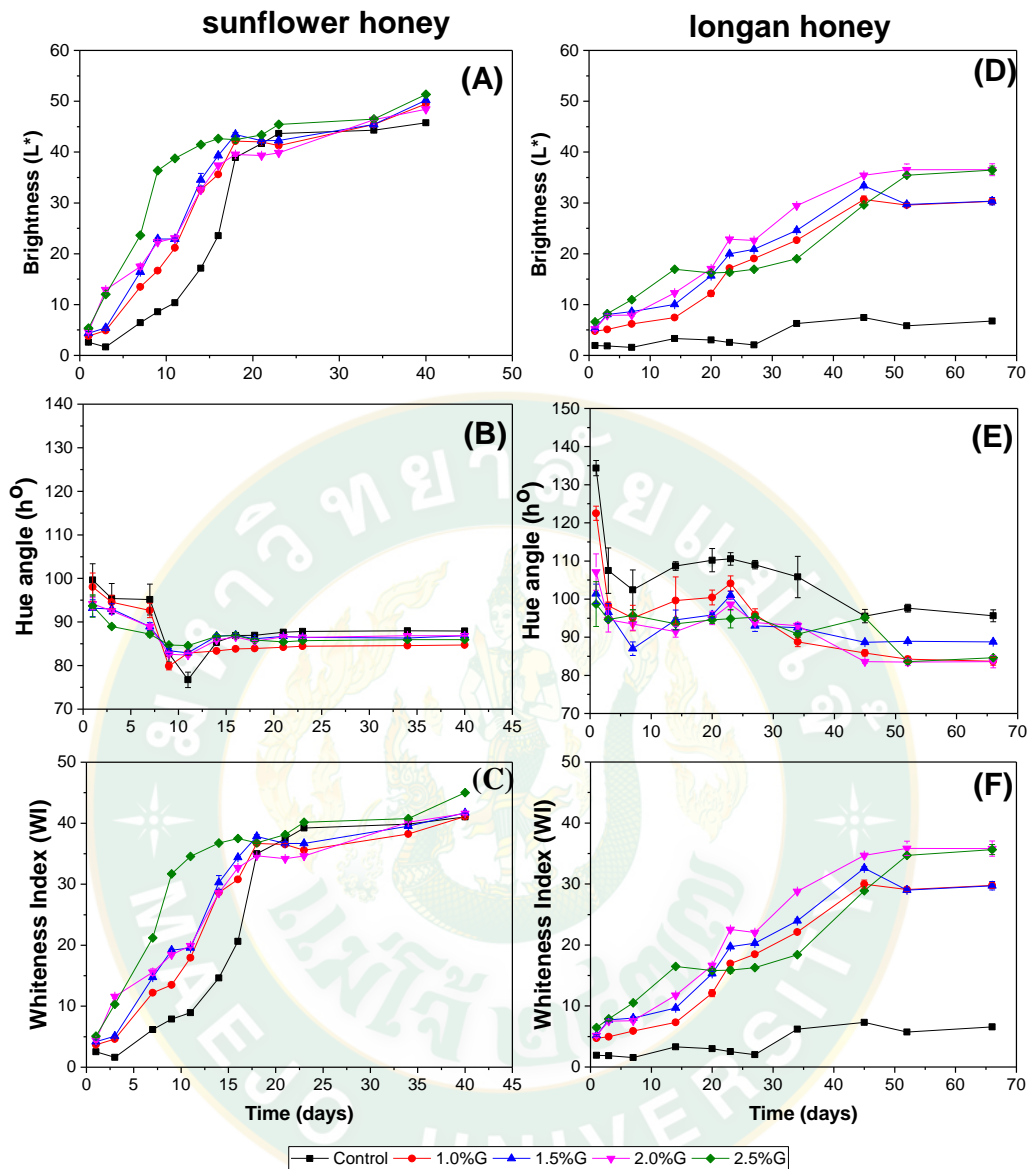

**Figure 23** The color value of  $L^*$  value, hue angle ( $h^\circ$ ) and Whiteness Index (WI) of, (A) – (C) sunflower honey and, (D) – (F) longan honey in different amounts of glucose powder addition during storage.

The *WI* of sunflower honey was higher than longan honey, but showed similar characteristics with a longer time longer period (Figure 23(C) and 23(F)). Costa et al. (2015) reported that honey samples stored at  $15^\circ\text{C}$  gained higher values than stored at  $25^\circ\text{C}$  and exponentially increased when the time increased. This increasing

of *WI* was due to the formation of crystals in the honey. Therefore, the color and the crystallization rate were involved in crystal formation during the crystallization process.

As part 4.1.1, dehydration by vacuum far-infrared dryer could reduce the moisture content and increased the G/W ratio higher than 2.16, it could stimulate the non-granulating honey into rapid granulating honey. But those method effected with the colour of honey, the liquid honey was darker than before treating. While, the glucose addition will get the better overall appearance, the colour of longan honey is brightness after glucose addition. Therefore, the glucose addition is the best method for further use to find the suitable process of creamed honey product.

From this part, the correlation between the absorbance at 660 nm and the crystallization time will further use to explain the crystallization kinetic by mathematical model in section 4.3 and the amount of glucose addition will further use in section 4.2.5.

## **4.2 Develop suitable process to produce creamed honey product**

From part 4.1, the different honey types and different physicochemical properties was presented in different rate of crystallization, because its composed of different content of glucose and moisture. Three main factors which were investigated in this part were including the moisture content, the glucose content and ultrasonic treatment. The solution findings should be concluded both in the factor affecting with texture and optimize procedure of its. Moreover, the storage condition for creamed setting and the time until the creamed was return into fully liquid will be study for declare the shelf-life of product. The texture of the final product will compare between developed process and Dyce's method (1931), and the experiment design are defined in section 4.2.1 to 4.2.5 and compare the efficiency in section 4.2.6.

### **4.2.1 Creamed honey process by Dyce's method**

Sunflower honey is used in raw material to establish the creamed honey production by Dyce's method and showed in Figure 24. Heating the liquid honey by

heating bath reached to  $49^{\circ}\text{C}$  and strained to remove any particles. Liquid honey is heated again to  $66^{\circ}\text{C}$  and rapid cooled to below  $24^{\circ}\text{C}$ . Total heating time is 45 mins and cooling time is 20 mins.

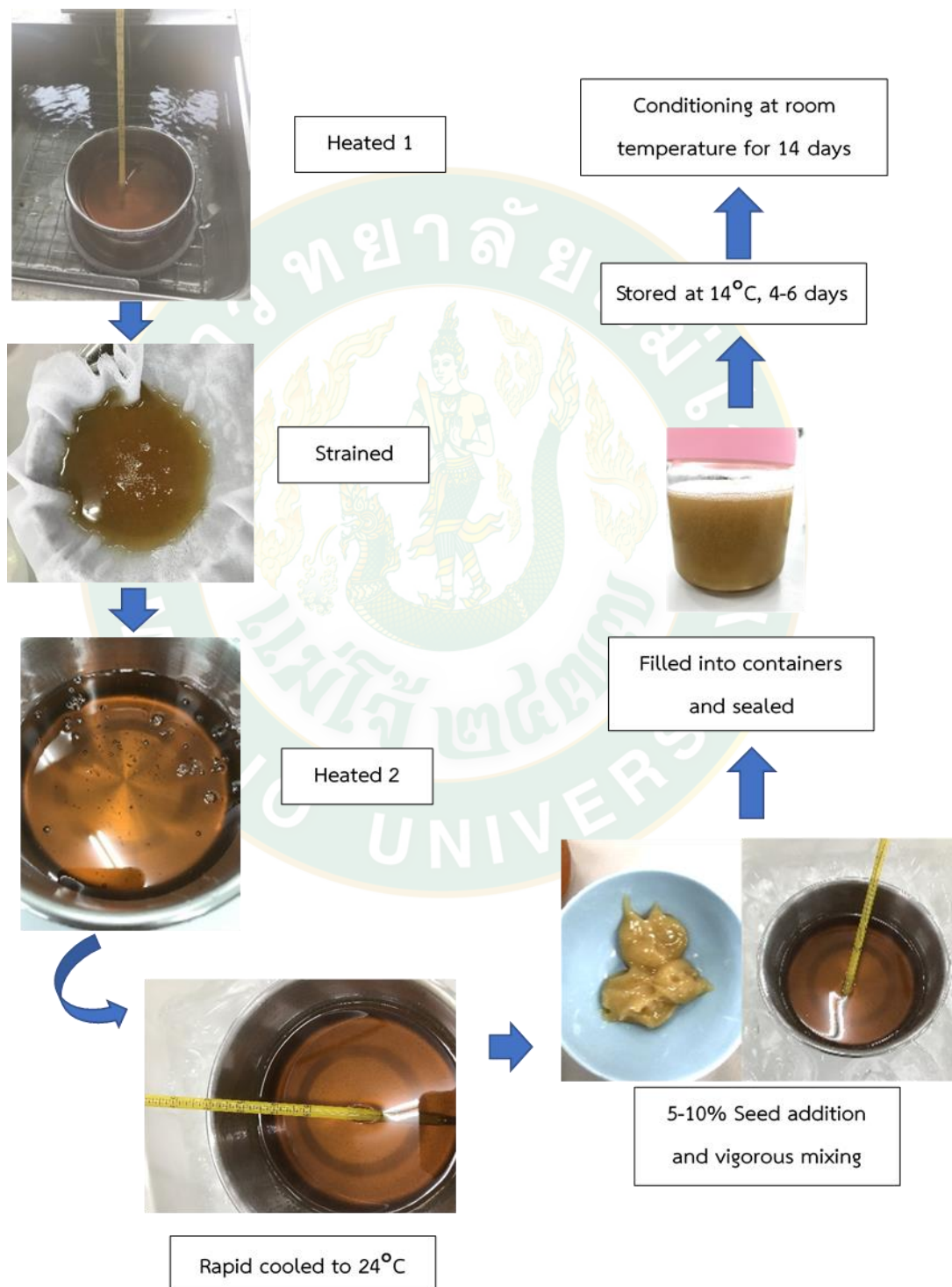

**Figure 24** Creamed sunflower honey by Dyce's method

Seed honey added 10%w/w and manually mixing by spatula about 10 mins. Total processing time is about 75 mins (since heating until mixing). The mixed honey is filled into containers and kept at chilled temperature (10-14°C). The hardness and time for obtained a fine textured creamed honey was monitored as showed in Figure 25.

Figure 25 showed the hardness of product increased when the storage time increased by starting from 0.0698 N to 35.620 N in 7 days. In day 6, the hardness is 12.658 N, adhesiveness is 16.322 N.sec, cohesiveness is 0.644 and gumminess is 19.356 N. Product appearance by Dyce's method showed in Figure 26. The creamed sunflower honey presented yellow color and obtained a fine texture in day 6. Similar as the texture of the commercial product (Airborne Manuka and Wildflower cream honey, New Zealand product) presented the hardness was  $14.97 \pm 0.202$  N and showed the smooth texture (Figure 27). In addition to the food product's texture or the food product which has the appearance like a creamy texture such as cheese, fruit jam or dairy product, the cone penetrometry is traditionally used to assess hardness in unit of N. Also, we selected the hardness value as the main parameter to evaluate the texture of creamed honey product and set the range of target value in 12 – 15 N for comparing with developed method in next part (Figure 28).

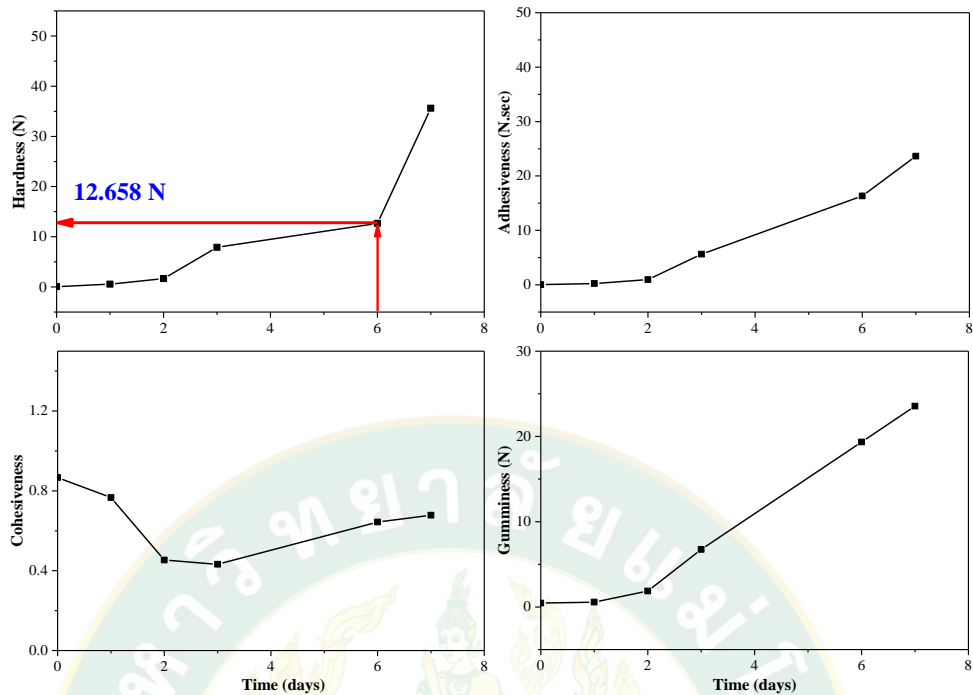

**Figure 25** Texture profile of creamed sunflower honey by Dyce's method

When the product got a fine texture, the creamed honey needs to be conditioned at room temperature for making the spreadability or a soft texture (Figure 26). The product kept in room temperature (25-28°C) and the result showed that the creamed sunflower honey by Dyce's method got about 14 days for obtain a soft texture.



**Figure 26** Appearance of creamed sunflower honey product by Dyce's method



Figure 27 Airborne Manuka and Wildflower cream honey, Airborne honey guardians, product of New Zealand

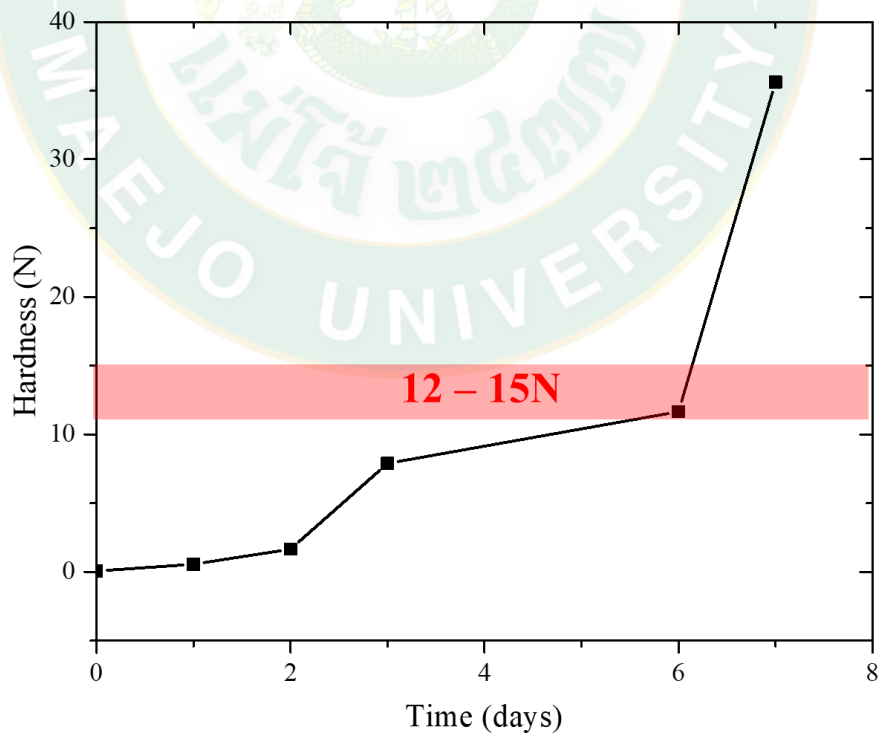

Figure 28 Target hardness value (N) of creamed honey product



#### 4.2.2 The enhancing crystallization with ultrasonic treatment in pre-heat process

From literature review, the ultrasonic treatment is an interest method that assisted liquefaction and pasteurization in honey product. But ultrasonic assisted crystallization or re-crystallization seem to be less information especially in honey, thus, the main objective of this experiment was to determine and compare the rate of heating honey by either ultrasound or heat treatment. Sunflower honey presented in rapid crystallization, also it was selected to study in this part. Schematic diagram of heating by heating bath and with ultrasonic as shown in Figure 29-31.



Figure 29 Heating honey by heating bath

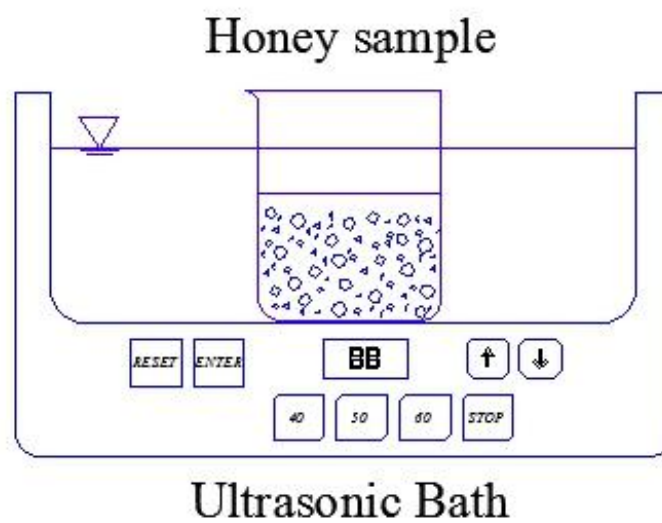

Figure 30 Schematic diagram of heating and ultrasonic treatment



Figure 31 Heating and ultrasonic treatment at 100 Watt power, frequency 40 kHz

Liquid sunflower honey was heated at 55°C for 30 mins, the heating time was evaluated from part 4.1.2, which confirm to the mild heating condition. Temperature profile of Dyce's method and developed method showed as Figure 32, it showed the honey temperature variation with the time during heating by Dyce's method and developed method (heating with ultrasonic treatment). To maintain the honey color and can kill the yeast in honey, ultrasonic treatment with 55°C for 30 mins is the suitable condition which promote the formation of liquid honey by dissolution of crystals and use further for control in raw material preparation of creamed honey process.

However, the heating process with high temperature adversely affected the quality of honey, especially in HMF and color, also clear liquid honey after heating treatment will further check the honey quality as shown in Table 18.

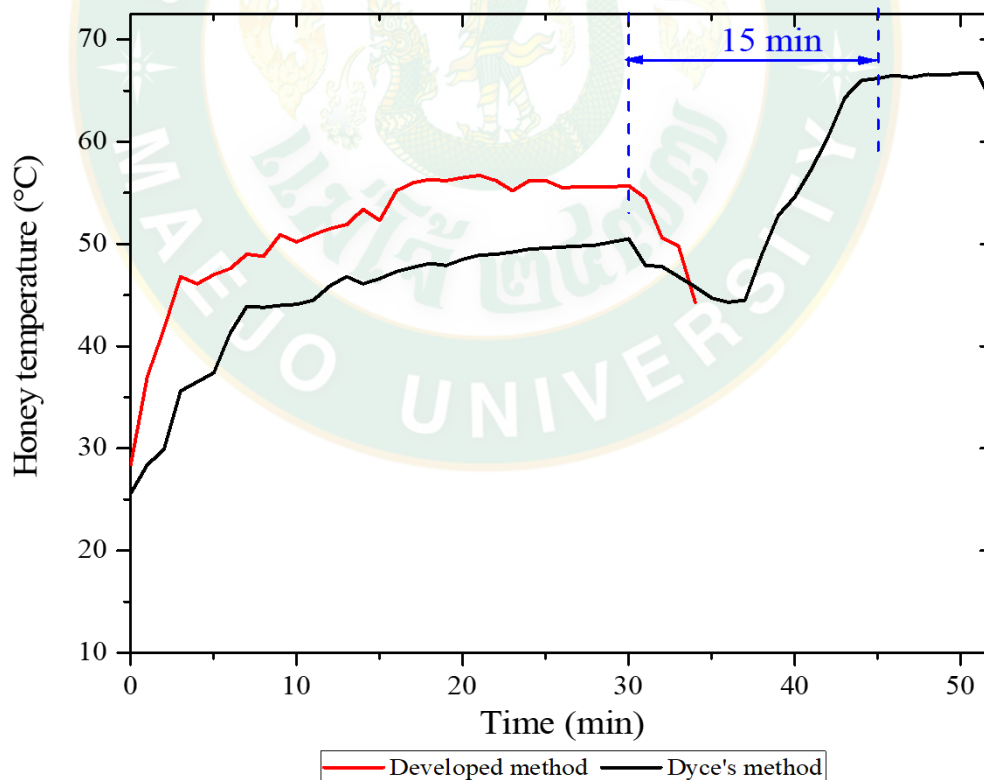

**Figure 32** Honey temperature profile at 55°C comparing between heating with ultrasonic 45 kHz and heating bath.

These heated honey samples were analyzed for their hydroxymethylfurfural (HMF) concentrations in mg/kg, and colour, since these quality parameters are normally used by the honey industry and regulators to gauge the heating history and quality of honey. Table 16 showed the values of HMF and color of heated sunflower honey by Dyce's method and developed method. The HMF content of samples increased after heating treatment in comparison with untreated samples. However, the average increase in HMF content due to developed method and Dyce's method were 32.52% and 86.59%, respectively. Similar with report of Thrasyvoulou et al. (1994) that showed the average of HMF content increased for 85.7% and 128.7% in ultrasound treatment and heat treatment, respectively. This confirmed that heating with ultrasonic treatment is the innovative idea of liquefying, pasteurizing and clearing any crystal in honey, since a high frequency (in this study use 40 kHz) decreased the time of honey liquefaction and eliminated the existing crystals which will prepare the liquid honey for ready to create a new small crystals in creamed honey product.

**Table 18** The heating time and the effect of heating on HMF and colour

Treatment	Temperature (°C)	Time (min)	HMF (mg/kg)	L*	a*	b*
Liquid honey	-	-	4.67±0.30 <sup>a</sup>	4.10±0.08 <sup>b</sup>	-0.93±0.31 <sup>N</sup>	4.33±0.28 <sup>b</sup>
Dyce's method	49 and 66	45	8.72±0.19 <sup>c</sup>	1.88±0.30 <sup>a</sup>	-0.38±0.37 <sup>N</sup>	0.44±0.30 <sup>a</sup>
Developed method	55	30	6.19±0.35 <sup>b</sup>	3.79±0.23 <sup>b</sup>	-0.90±0.05 <sup>N</sup>	4.78±0.41 <sup>b</sup>

The effect of heating treatment on the luminosity ( $L^*$ ) of sunflower honey showed differences. The lightness values ( $L^*$ ) of fresh liquid honey is 4.10±0.08 which showed in light clear yellow color. The  $L^*$  values of heated honey by Dyce's method were significantly differencing with fresh liquid honey, the lightness decreased after heating. While, it was not significantly differenced with heating with ultrasonic treatment. The decrease could be attributed to Maillard reaction, fructose

caramelization and polyphenol reactions. The increase in flavonoids that contain in honeys they are related to the color, and the increase effect could be due to the reduction in crystal size. Similar with  $b^*$  value, the result showed significant difference ( $p < 0.05$ )  $b^*$  by Dyce's method. These changes could be due to the cavitation effect producing physicochemical reactions (Quintero-Lira et al., 2016).  $b^*$  value demonstrated in yellow hue and the results showed that  $b^*$  values of honey with Dyce's method significantly decreased, while its showed non-significant difference in heating with ultrasonic treatment of  $55^{\circ}\text{C}$ .



**Figure 33** Honey after heating by developed method and Dyce's method

Liquid honey was observed the crystal before heat treatment, sunflower and longan honey were subjected to observe in crystal shape and size by light microscope. The results shown that the crystal of sunflower and longan honey showed large, long and sharp (Figure 34). The crystal shape was pentagonal or hexagonal, and dispersed in single crystal. The crystals of sunflower honey were found small needle size when comparing with the crystals in longan honey as shown in Figure 33(A) and 33(B), respectively.

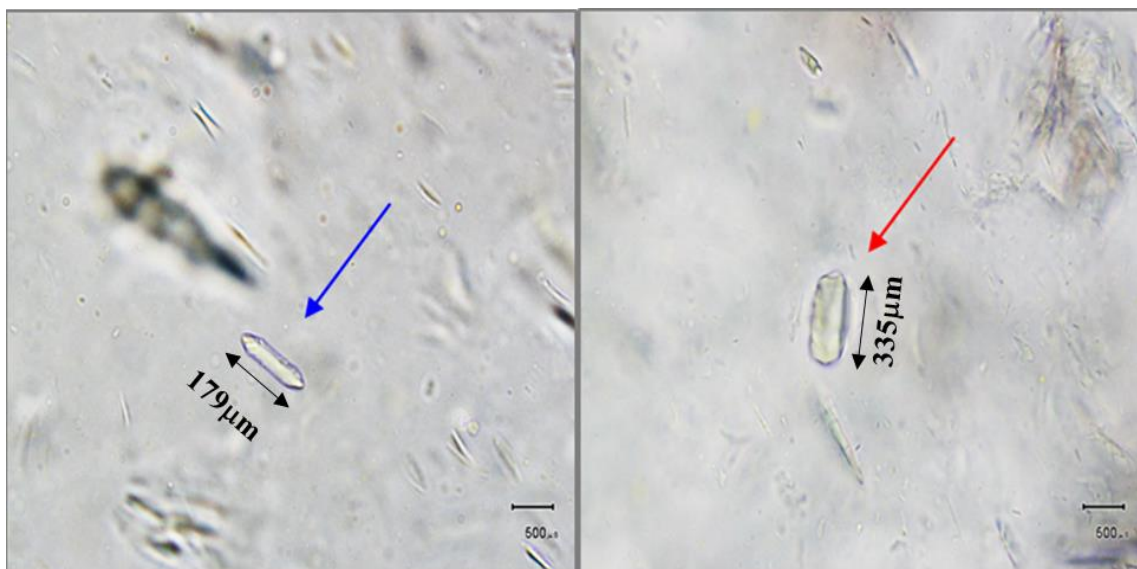

Sunflower honey

Longan honey

**Figure 34** Microscopic observation of honey crystals before heating with ultrasonic treatment

After liquid honey samples were treated by heating with ultrasonic treatment at 55°C for 30 mins, there were not found any crystal in liquid honey as shown in Figure 35.

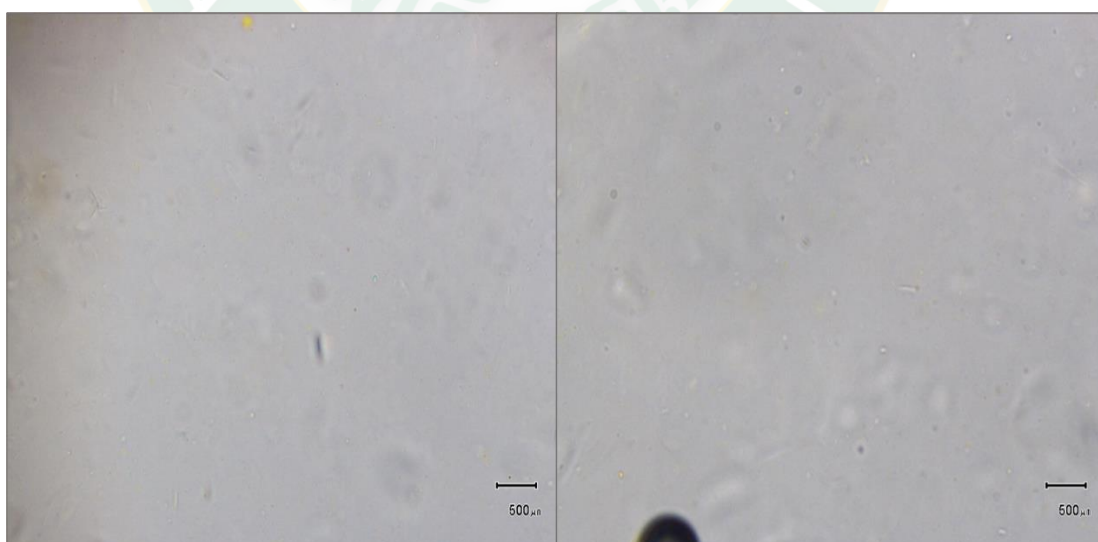

Sunflower honey

Longan honey

**Figure 35** Microscopic observation of honey after heating with ultrasonic treatment

Therefore, the heating with ultrasonic treatment at 55°C for 30 mins is the suitable heating process by obtain the least processing time and the best benefit in creamed honey production. Moreover, not only destroy microbe and maintain the quality of honey, but also fully eliminate any crystals which may affect with formation of new nuclei in the creamed honey product. In addition, the temperature up to 55°C is the accepted conventional process or thermal treatment for honey liquefaction or eliminating existing crystals, destroy microbe and due to the limitations of heat treatment which need to provide a non-thermal alternative for controlling the crystallization of honey, ultrasonic treatment required alternative technology for creamed honey production. Moreover, If thermal processing in high temperature can increase HMF content which is the main indicator of honey overheating (Bucekova et al., 2018) and further control the nucleation phenomena or control the re-crystallization process in creamed honey production. Therefore, to design the developed method to produce creamed honey, the process should be done in the shortest time without effect with the quality of the product.

#### **4.2.3 The optimal cooling condition**

The rate of cooling of a mass to a desired crystallization temperature, as in production of crystallization of creamed honey, determines the extent and type of nucleation. If the heated honey is cooled uniformly and rapidly to the desired processing temperature, in this study must be below to 24°C, all the mixed honey will crystallize at the same condition and at the same time. Therefore, rate of cooling is very important in systems where crystallization is undesired.

Figure 36 showed the temperature profile of honey in heating and cooling process. Ultrasonic with 100 Watt power, 40 kHz of frequency treat for heating process for eliminate any crystals and pasteurize of liquid honey in step of raw material preparation. The results showed that the honey temperature decreased below to 20°C within 5 mins in cooling with chilled water (3 – 5°C) and obtained the cooling rate of 6.50°C/min. But in case of the honey was cooled with chilled water

(10 - 15°C), it took time for over 90 mins to cooled liquid honey down below to 20°C (cooling rate is 0.35°C/min).

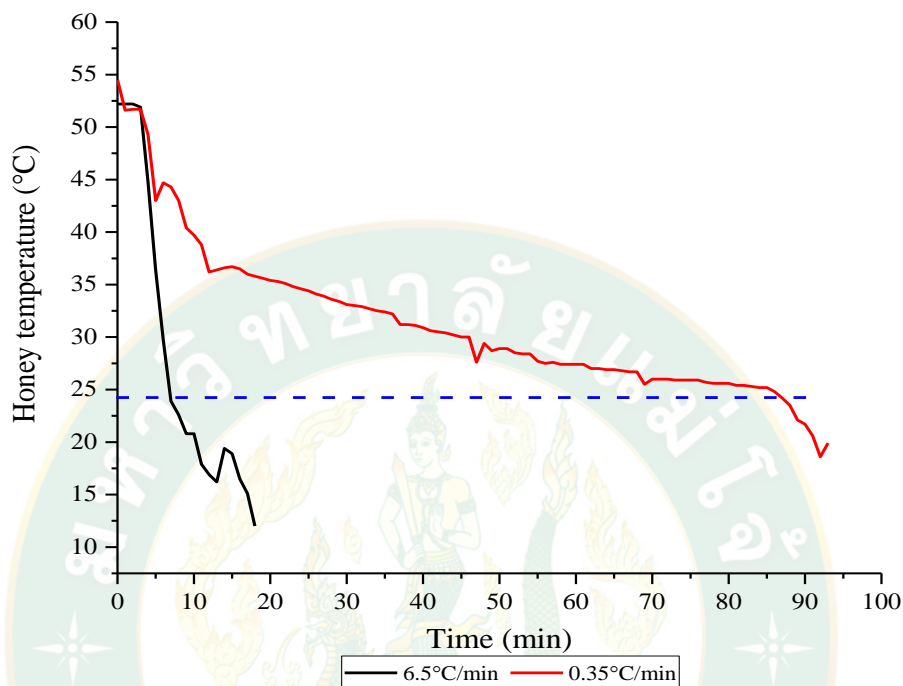

**Figure 36** Honey temperature profile in different cooling rate

Rapid cooling rate at 6.50°C/min will further used to comparing the cooling time between method of Dyce and developed method. The result showed in Figure 37, the cooling time of Dyce's method is 20 mins for decreasing the heated honey from 66°C to below 24°C, while the cooling time of developed method is about 5 mins. This cooling condition will further use to find the suitable method for creamed honey production.



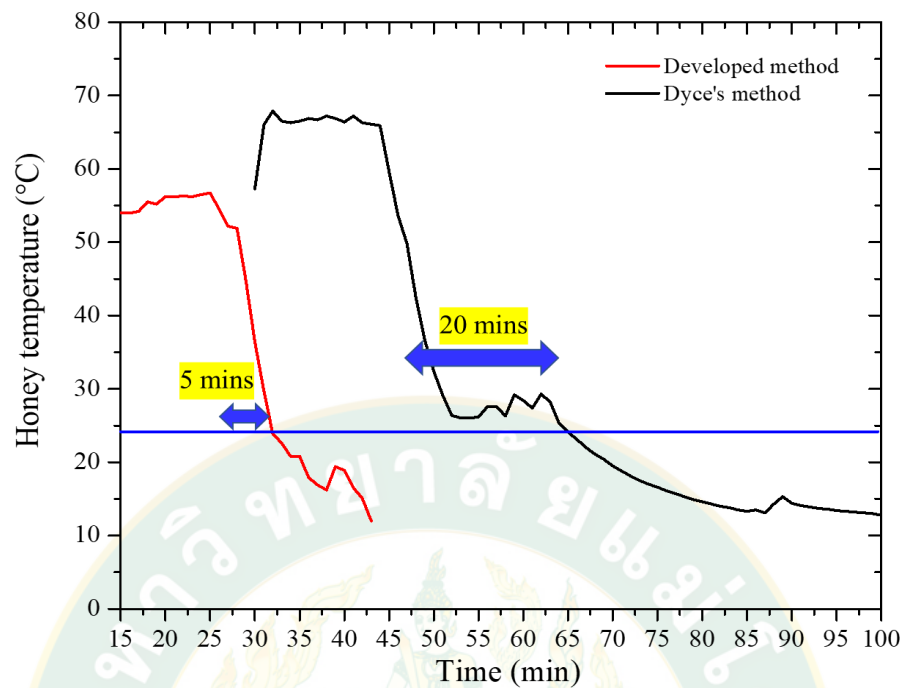

**Figure 37** Honey temperature profile during rapid cooling rate at  $6.50^{\circ}\text{C}/\text{min}$  comparing between Dyce's method and developed method

These results were similar with the report of Herrera and Hartel (2000a) who studied the rate of cooling affects the amount of crystalline mass, the polymorph formed and the crystal habit in lipid products. They found that the crystals were smaller when the lipid melt was cooled rapidly. The different crystalline microstructures resulted in significantly different mechanical properties, which lead to different texture. Therefore, the liquid honey should rapidly cool below to  $20^{\circ}\text{C}$  with chilled water ( $3 - 5^{\circ}\text{C}$ ) after the honey heating with ultrasonic treatment for obtaining fine texture in creamed honey product.

#### 4.2.4 The optimal amount of seed addition and speed of agitation

The texture profile is the main indicator to decision the suitable seed amount. The texture profile of creamed sunflower honey by Dyce's method (part 4.2.1) was set in the target storage time for keeping in chilled temperature.

The hardness (N) is the maximum force at the positive highest peak and the adhesiveness (N.s) is the maximum negative force area after compression. The ratio between peak and adhesive forces, which relates the positive compression force and the negative pulling force, was calculated as cohesiveness (Shinn and Wang, 1990). From Figure 37, the hardness increased when the storage time increase, it meant that the creamed honey would start to set and become to firm in chilled temperature. However, the tight texture in creamed honey seem to be not good in term of spreadability, so the hardness value should be reaching the target value (12 - 15 N, red area in Figure 38).

The creamed product should firm in three days in chilled temperature and in fact, to produce fine crystals, many seeds or nuclei of solids must be present in the honey (Crane, 1980). The initial hardness value of honey with seed addition by 5%, 7.5% and 10% (w/w) were 0.0098 N, 0.0698 N and 0.9698 N, respectively, and continue increased with storage time increased.

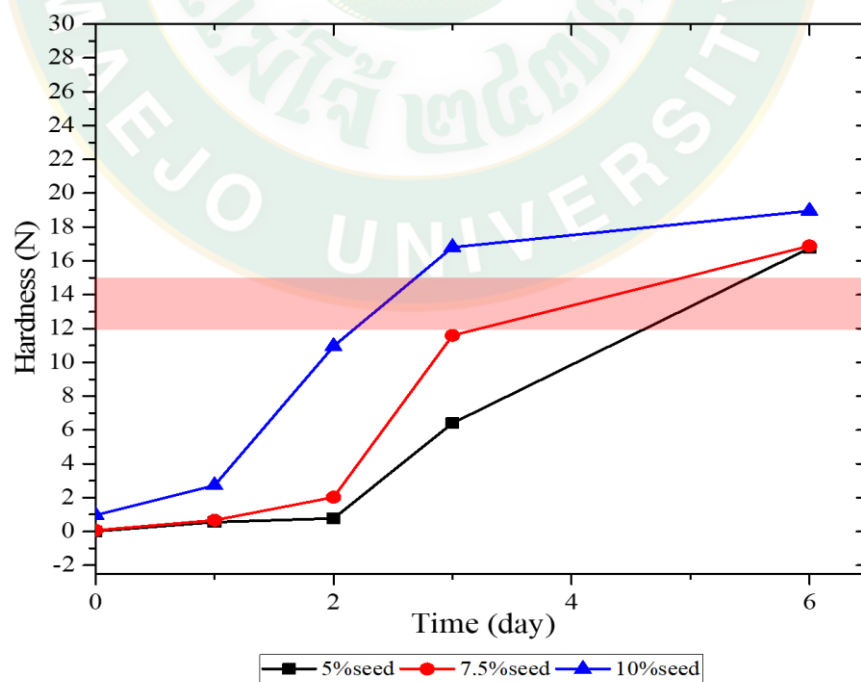

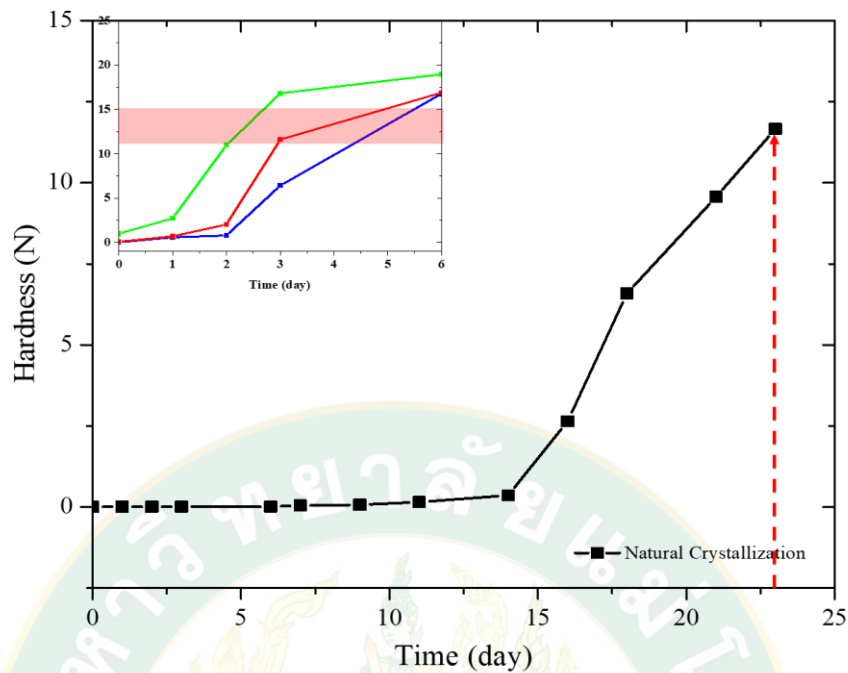

**Figure 38** Effect of seed addition on texture profile during keeping in chilled temperature.

While, the control sample or the sample without seed addition got the initial hardness in 0.0056 N and slowly increased into 11.658 N in day 23 (black curve, Figure 38). The honey with 10%(w/w) presented rapid increased of hardness value after chilled in overnight and reached to target value (12-15N) within 3 days, while the hardness value was slowest increase with honey with 5%(w/w). The honey with 5%(w/w) seed addition took the time for 6 days for obtain firmness texture in creamed honey product. When we added the seed honey only 5%(w/w), the hardness of creamed honey is 16.756N within 1 week and texture reached to the target hardness value (12-15N). While, the highest crystallization rate showed in the honey with 10%(w/w) seed addition, the hardness value reached to the target in day 3 (16.803 N). It showed that the higher seed addition, the higher hardness value in chilled temperature storage. However, the over quantity is not the best, it will increase the cost of manufacturer.



**Figure 39** Creamed sunflower honey appearance in different amount of seed addition

The creamed honey should have the texture like butter, finely granulated honey makes an exceptional spread in the short time. Therefore, the suitable amount of seed addition for sunflower honey is 7.50% - 10%(w/w) for obtaining smooth texture and reached the hardness similar with commercial product or 12-15

N within 3 days in chilled temperature. However, the amount of seed addition differed following honey type and honey properties, so we further study in longan and wild honey which is the most popular honey in Northern Thailand also.

To obtain the data for honey processor in another options, longan and wild honey were the honey samples of non-granulating honey in Thailand and should find the suitable process of creamed honey product for value added in the future.

From the result of part 4.1, the glucose addition is the best method for stimulate in creating in creamed honey product, but excess and less amount of glucose addition cannot produce the smooth texture of creamed honey product in next. The suitable seed addition in longan and wild honey shown in Table 19.

**Table 19** The relation of seeding addition and storage time in each honey type

Type of honey	% of seeding addition (w/w)	average of G/W ratio	Storage time to reach the target hardness (day)	Type of cream
Sunflower honey	2.0 (Control)	2.05	7	Medium
	5.0		5	Medium
	7.5		3	Very fine
	10.0		2	Very fine
Longan honey	2.0 (Control)	1.77	27	Medium
	10.0		10	Medium
	12.5		6	Very fine
	15.0		3	Very fine
Wild honey	2.0 (Control)	1.63	-	-
	10.0		-	-
	12.5		30	Fine
	15.0		7	Very fine

The result shown in Table 19, regarding the amount of seed addition will differ following the glucose content or the crystallization rate, so the suitable amount of its should be classify following the type of honey. The result showed that longan and wild honey are categorized as slow or non-granulating honey because

the fructose per glucose ratio (F/G ratio) relatively close to 1.33 (White Jr, 1975). Moreover, when the moisture content is changed, it will affect with the glucose per water ratio (G/W ratio) also. The average of G/W ratio were 1.77 and 1.63 in longan and wild honey, respectively. Sunflower honey is fast-granulating honey, so it can crystallize within 1 week or the creamy texture obtained with seed addition in range of 5 – 10%(w/w). While longan and wild honey cannot produce in creamy on set texture with these range of seed addition, the product was close to liquid phase (Figure 38). Keeping in refrigerator for 50 days, both of its could not be set in creamy texture. Therefore, the amount of seed addition increased into 10 – 15% w/w and the result showed that the creamed longan honey set in creamy texture in 7 days by seed addition in 12.50%(w/w), while wild honey use for over 30 days. If the seed addition increased into 15.0%(w/w), it used only 3 days for set in the creamy texture in longan honey, and 7 days in wild honey.



**Figure 40** the appearance of creamed honey in different type

Regarding the G/W ratio of wild honey is the lowest at 1.63, it will seem to never crystallize during storage, although keeping in chilled temperature. Therefore, the increasing of seed nuclei for stimulating the crystallization in wild honey should be done, and the result showed that the creamed wild honey presented creamy texture in 7 days at the seed addition of 15.0%(w/w). Therefore, the suitable amount of seed addition in each honey type concluded in Table 20.

**Table 20** The amount of seed addition in each honey type for produce creamed honey product within 1 week

Product type	G/W ratio	Amount of seed addition (%w/w)
Creamed sunflower honey	$\geq 2.0$	7.5 – 10.0
Creamed longan honey	$\sim 1.70$ or less	15.0
Creamed wild honey	$< 1.70$	$> 15.0$

After the creamed honey is heated and cooled with the desired temperature, added the seed honey in the suitable amount, the suitable agitation is the parameter for studying in next. In products where massive nucleation is desired, it is important to provide sufficient agitation to promote maximum nucleation. Mechanical energy input enhances the nucleation process and lower and rapid agitation energy resulted in crystals formation in creamed honey product. In this part, only the creamed sunflower honey used in the experiment because the different compositions of honey did not affect with agitation speed. Intensity of agitation is divided into 2 levels; slow agitation and rapid agitation are the speed in range of 100 – 300 rpm and 1,000 – 1,300 rpm (Figure 41).



**Figure 41** Speed of agitation for mixing the cooled liquid honey and seed honey

Regarding Dyce's method specified that the product should manually mixing with spatula until the homogeneous product obtained, so we set into slow agitation or speed about 100 – 300 rpm. Mixed honey was agitated in chilled water to maintain the temperature because if honey temperature increases in warm condition, it may dissolve small crystals in the seed honey. Thoroughly mixed honey is filled into glass bottles, sealed and kept at 10 - 14°C for texture measurement. The result showed that the product did not thoroughly in homogeneous or it is non-homogeneous mixed honey as shown in Figure 42, while agitating with rapid speed into 1,000 – 1,300 rpm presented homogeneous between liquid and seed honey as shown in Figure 43.

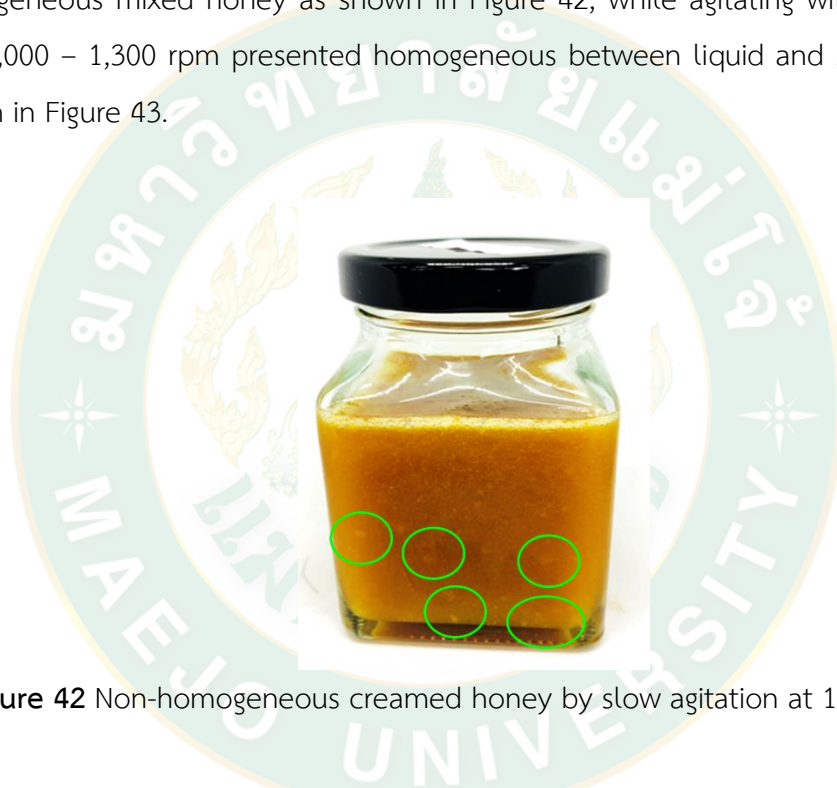

**Figure 42** Non-homogeneous creamed honey by slow agitation at 100-300 rpm



**Figure 43** Homogeneous creamed honey by rapid agitation at 1,000 – 1,300 rpm



Moreover, the speed at more than 1,300 rpm will present many air bubbles and must take off on the layer after keeping in refrigerator overnight. The air bubbles will create the white layer on top of creamed honey, it is not good with overall appearance (Figure 44). Once the creamed honey has had time to rest, skim off any bubbles that have risen to the surface.

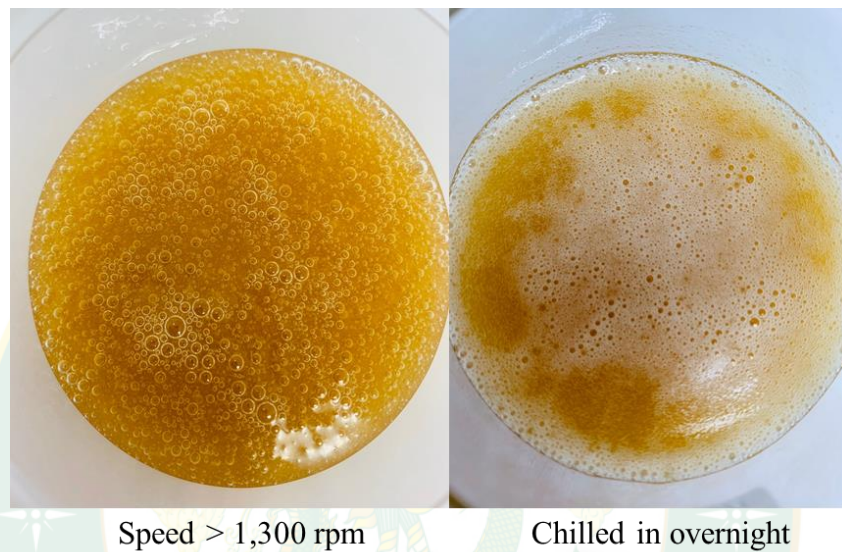

**Figure 44** Creamed sunflower honey after agitation test at > 1,300 rpm

Therefore, to obtain a creamed honey with smooth texture with firmness of cream, the slow agitation should not over than 1,300 rpm, for mixing the honey after seed addition is the suitable condition for this research.

#### 4.2.5 Effect of ultrasonic in post-treatment

The ultrasonic treatment may apply for controlling crystallization by desired uniform crystal size and shape in re-crystallization process and may further present the good texture in creamed honey (Deora et al., 2013). From section 4.2.4 which concluded that the mixing step should be done in chilled water at temperature of 3 - 5°C to control the uniform of crystal formation. In this part will observe the effect of ultrasonic treatment during agitation and ultrasonic treatment before keep in refrigerator on the texture profile of creamed honey.

From Dyce's process (D'Arcy, 2007; Dyce, 1931a, 1931b), the crystallization will continue in crystal nucleation after seed addition. Normally, the crystal growth and nucleation will occur during thoroughly mixing and keep in cold storage. Moreover, sonocrystallization as post-treatment assists for controlling initiation of nucleation and crystal shape. Therefore, to reduce the time in this step, ultrasonic treatment at 40 kHz and intensity at  $0.15 \text{ W/m}^2$  in chilled water will use to stimulate the speed of crystallization and the experiment shown as Figure 45.



**Figure 45** the mixed honey was treated with ultrasonic at 40 kHz and  $0.15 \text{ Watt/m}^2$  in chilled water

The metastable zone width (MZW) is the area between an equilibrium saturation curve and the experimentally observed supersaturation point at which nucleation occurs spontaneously as shown in Figure 46. For sonocrystallization, 40 kHz and  $0.15 \text{ W/m}^2$  of ultrasonic was used and showed as red dash line. For the unsonicated cases, a rapid stirring without ultrasonic treatment was used to mix the creamed honey and showed as blue dash line. There are several ways to generate crystals, in this case, the crystallization of creamed honey occurred from cooling and seed addition (ABCD line, green dash line) (Kim and Suslick, 2018). For the generation

of crystals, the status of a mixed honey changes from stable to metastable to labile (stable). At temperature below 24°C (point B), the mixed honey started to create a nuclei until the honey temperature below to 10°C (point C), the homogeneous of creamed honey completed.

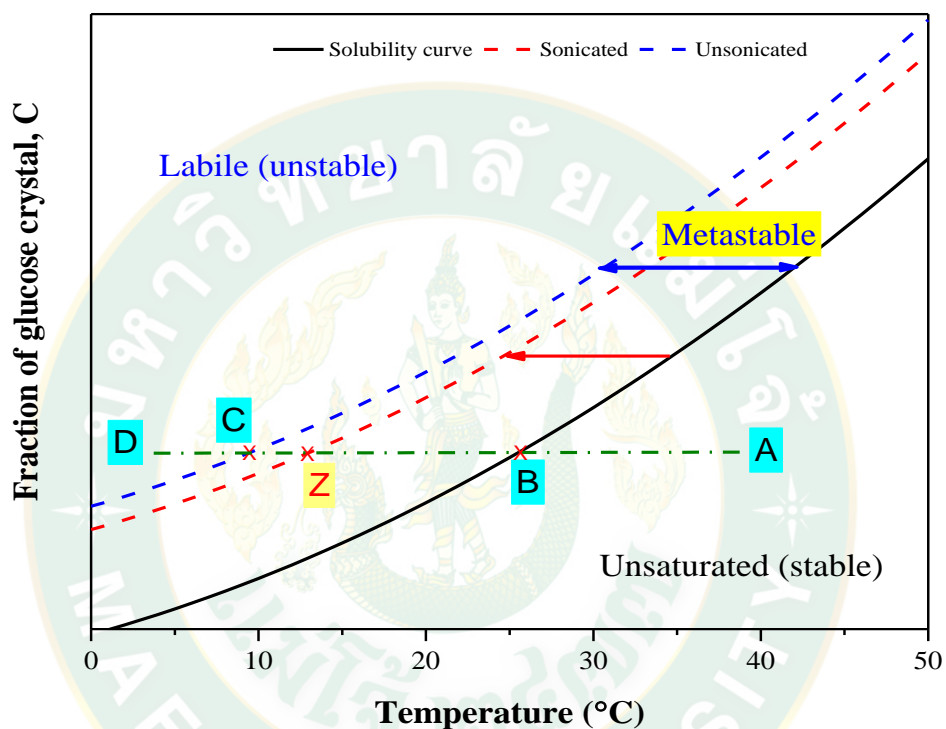

**Figure 46** Effect of ultrasonic treatment on the metastable zone width (MZW) of crystallization in creamed honey

When the mixed honey is treated with ultrasonic 40 kHz and 0.33 W/g, the MZW decreases (ABZ line). During sonocrystallization, gas-filled crevices surrounding dust motes behave as new nucleation sites causing an increase in the rate of nucleation. Additionally, microscale mixing and turbulence improves from the collapse of bubbles during sonocrystallization. They accelerate diffusion of solutes and increase the nucleation rate. Due to such increased nucleation sites and improved mixing efficiency, sonocrystallization reduces the MZW.

All creamed honey product was observed the crystal and the result showed that creamed honey contained many small crystals. The small and sharp crystal have a shiny appearance as shown in Figure 47.

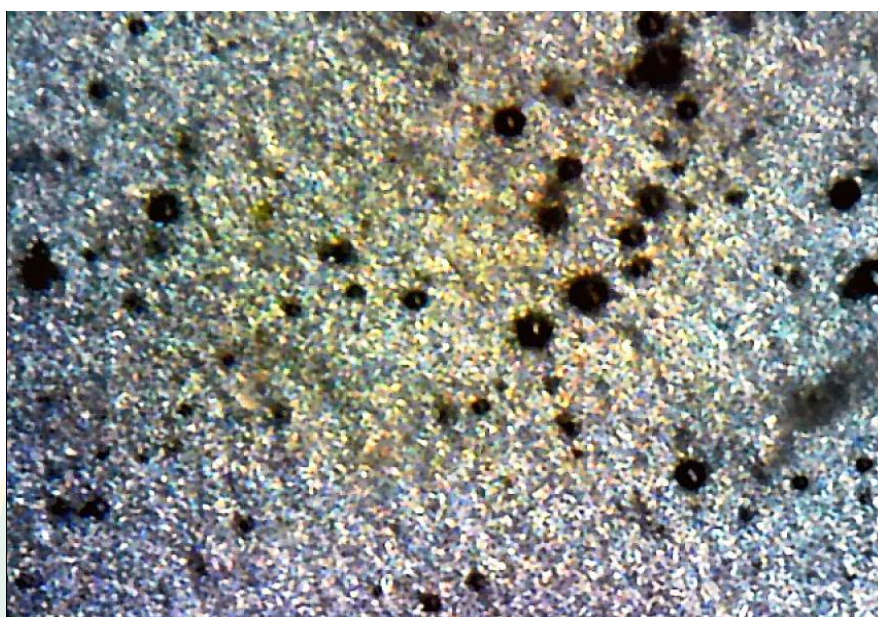

**Figure 47** Small glass crystals contained in creamed honey product

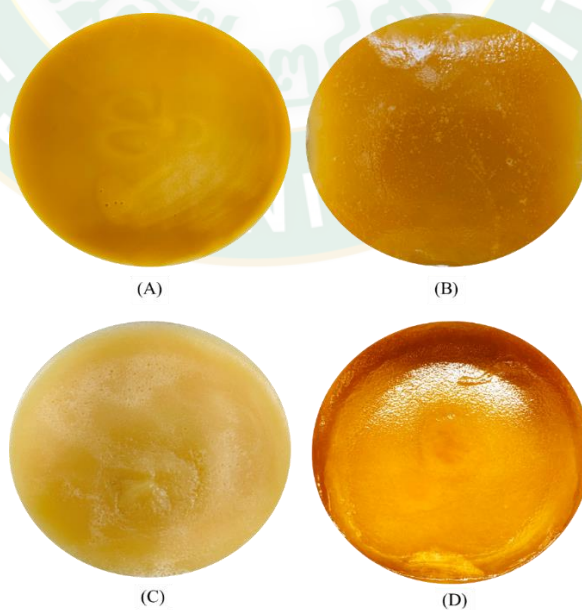

**Figure 48** Creamed honey appearance of (A) sunflower honey (B) longan honey (C) wild honey (D) commercial creamed honey

#### 4.2.6 Effect of storage condition and the product shelf-life

##### 1) The optimal time for chilled temperature storage

Liquid honey was treated by ultrasonic at 55°C, 30 mins for pasteurization and crystal elimination, then rapid cooled by chilled water (3-5°C) until the honey temperature below to 20°C (cooling rate 6.5°C/min). Suitable amount of seed honeys was added following the G/W ratio and rapidly agitated until homogeneous appearance. The creamed honey was filled into glass bottle, treated with ultrasonic in chilled water and kept in refrigerator or chilled temperature at 10-14°C for obtain a fine textured creamed honey or until the final hardness value reach to the target value. The storage time in chilled temperature for obtain a fine texture was differed following the honey types as shown in Table 21.

**Table 21** The suitable storage time in each creamed honey type

Creamed honey type	Storage time in chilled temperature (day)	Hardness (N)	Storage time in chilled temperature (day)	Hardness (N)
	Unsonicated		Sonicated	
Sunflower honey	3	13.530 ± 0.288	2	14.265 ± 0.025
Longan honey	3	13.426 ± 0.292	2	14.006 ± 0.118
Wild honey	7	12.282 ± 0.290	6	13.958 ± 0.015

From the result of part 4.2.4, the suitable seed addition was 7.5 – 15%w/w and the storage in chilled temperature were different following the honey type. After the mixed honey was treated with ultrasonic at 40 kHz for 5 mins, it could reduce the MZW and further reduce the chilled storage time also. From table 21, the hardness value reached to target (13-15N) within 2 and 6 days with creamed sunflower, longan and wild honey, respectively. As the report of Kim and Suslick (2018) which reported that the ultrasonic treatment will increase in the rate of nucleation, increased nucleation sites, improved mixing efficiency and so reduced

the metastable zone width. Therefore, ultrasonic treatment before keeping in chilled storage could reduce the storage time of creamed honey product.

## 2) The conditioning time in low temperature (18-22°C)

After creamed honey presented a firm texture and presented a fine textured creamed honey, finally, the finely granulated honey needs to be conditioned for obtaining a soft texture. All creamed honey type will place at room temperature and checked the soft texture by visual observation and the result showed in Figure 49.

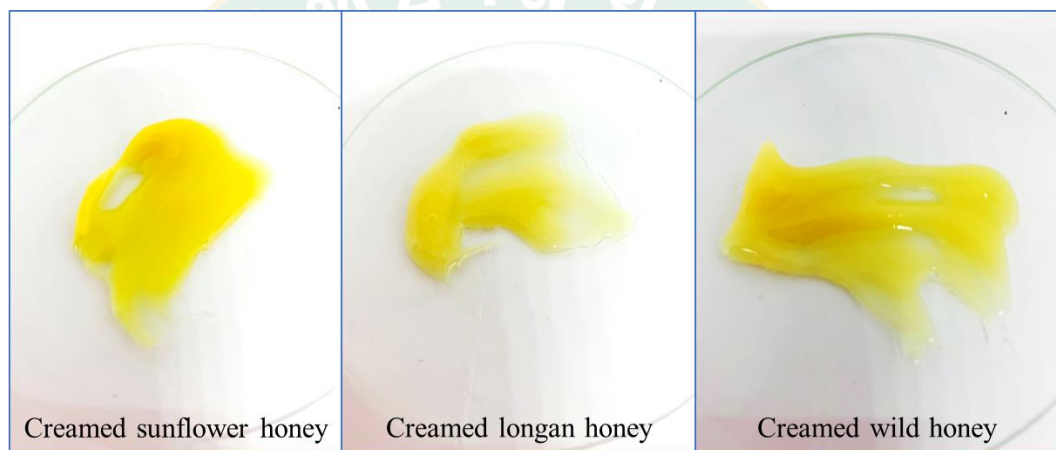

**Figure 49** The spreadability observation of creamed honey

Finally, the finely granulated honeys need to be conditioned at 18-22°C for 1 day or until a soft texture results, making the creamed honey acceptable to consumers. However, after such softening, creamed honey will not return to its original hardness even if stirred or the storage temperature change.

## 3) The consistency and product shelf-life

Regarding there is a chance that the creamed honey product will change during storage in warm temperature or room temperature in Thailand (28-30°C). The crystal will melt when the temperature increased, so it returned into liquid form. The longan and wild honey started melting only in 7 days and the liquid form increased

when the storage time increased. The overall appearance of creamed honey product in day 90 as shown in Figure 50.



**Figure 50** Creamed honey product stored in 28-30°C in day 90

The consistency is the texture property in creamed product, like a creamed honey product, the time until the creamy texture return into the liquid form is the indicator to confirm the product shelf-life. From Table 22, the result showed that creamed sunflower honey did not found the liquid layer until 1 month, 1 mm of the depth of liquid occurred in the bottle of creamed product. The percentage of consistency in creamed sunflower honey decreased below to 95% for 2 months, while, creamed longan and wild honey presented the liquid layer were 8 and 11.5 mm or about 73% and 62% of consistency, respectively. The target of consistency should not be lower than 95%. 1.0 – 1.5 mm of liquid layer could remake to creamy texture again by manual mixing but the reprocess will difficult if the depth of liquid layer is higher than 1.5 mm, especially in creamed longan and wild honey product. Therefore, creamed sunflower honey can be stored at room temperature for 2 months without variation of texture, while creamed longan and wild honey should not be stored at room temperature or at least 1 week to prevent the creamed honey from returning to the liquid form.

**Table 22** The consistency of creamed honey during keeping in room temperature

Type of honey	Storage time (day)	The depth of liquid form (cm)	%consistency
Creamed sunflower honey	1	0	100
	7	0	100
	14	0	100
	21	0	100
	30	1	96.67
	60	2	93.33
Creamed longan honey	90	3	90.00
	1	0	100
	7	0.5	98.33
	14	1	96.67
	21	1.5	95.0
	30	3	90.0
	60	5	83.33
90	8	73.33	
Creamed wild honey	1	0	100
	7	2	93.33
	14	4	86.67
	21	7	76.67
	30	9	70.00
	60	10	66.67
90	11.5	61.67	

Moreover, differential scanning calorimetry (DSC) was used the technique for monitoring the crystal variation during keeping in room temperature. The experiments were conducted from -65 to 200°C to obtain the complete thermal behavior of creamed honey from low to high temperature.



An endothermic peak appears in the temperature range of 30-60°C, which is the transition of crystal melting. These peaks are not present in all liquid honey samples because a peak in the thermograms corresponds to the melting of crystals in honey. There is no crystal in pure sunflower, longan, and wild honey, while the creamed honey samples consist of glucose crystals. Moreover, there is only one peak in the thermogram, which indicates that there is only one type of crystal (Nurul Zaizuliana *et al.*, 2017). The enthalpy of melting ( $\Delta H_m$ ) was computed from the area of the endothermic peaks in the range of 30-60°C, so the more granulated honey was the greater the recorded area.

**Table 23** Transition temperature ( $T_{onset}, T_{midpoint}$ ), enthalpy of crystal melting ( $\Delta H_m$ ), peak of temperature ( $T_{peak}$ ) and enthalpy of sugars fusion ( $\Delta H_f$ ) of liquid and creamed honey in three types: sunflower, longan and wild honey.

Sample	F/G ratio	G/W ratio	Thermal phenomena					
			Glass transition, $T_g$		Crystal melting		Fusion of sugars	
			$T_{onset}$	$T_{midpoint}$	$T_{onset}$	$\Delta H_m$	$T_{peak}$	$\Delta H_f$
SU	1.09	2.05	-45.45	-42.23	N	N	134.83	171.240±0.547 <sup>a</sup>
LG	1.24	1.77	-48.48	-45.04	N	N	124.67	199.303±1.130 <sup>b</sup>
WD	1.22	1.63	-48.95	-45.17	N	N	132.80	221.577±3.376 <sup>c</sup>
CR-SU	0.97	2.16	-48.30	-44.49	27.78	2.140±0.010 <sup>c</sup>	133.83	171.607±0.349 <sup>a</sup>
CR-LG	1.14	1.82	-48.55	-45.09	27.43	0.613±0.006 <sup>b</sup>	130.50	224.170±0.209 <sup>b</sup>
CR-WD	1.08	1.71	-49.37	-45.96	27.60	0.033±0.002 <sup>a</sup>	136.83	226.350±0.568 <sup>c</sup>

Note: N, not measured due to absence  $T_{onset}, T_{midpoint}, T_{peak}$  in °C;  $\Delta H$  in  $J/g$

A higher glucose content corresponds to a higher enthalpy of crystal melting. Creamed sunflower honey has the highest enthalpy ( $\Delta H_m$ ) of 2.140±0.010 J/g (Table 23) due to the highest glucose content (38.30%). According to Lupano (1997), with a greater peak area, more granulated honey crystals are present, and more activation energy is required to melt the crystals. Therefore, the low-temperature storage and seeding addition during the creamed honey processing may initiate the

nucleation process, since sugar molecules have sufficient mobility to form a crystal lattice, and the peak can be observed after seven days of storage.

Therefore, the change in enthalpy of crystal melting ( $\Delta H_m$ ) is a proper parameter to study the crystal variation of creamed honey and used to find the relation with the changes in texture during storage. Then, an endothermic peak was observed to study the change in enthalpy of crystal melting in room temperature, so thermograms of creamed honey in the range of crystal melting (30-60°C) were observed and shown the result in Figure 51.

In most types of creamed honey samples, when the storage time increased, the recorded area of the peak decreased during storage at room temperature (Figure 51(A) – 51(C)). The recorded area under the endothermic peaks are due to the melting of glucose crystals, and their integration shows the relative melting enthalpy. Thus, the honey crystal dissolved, and the enthalpy of crystal melting should be decreased during storage.

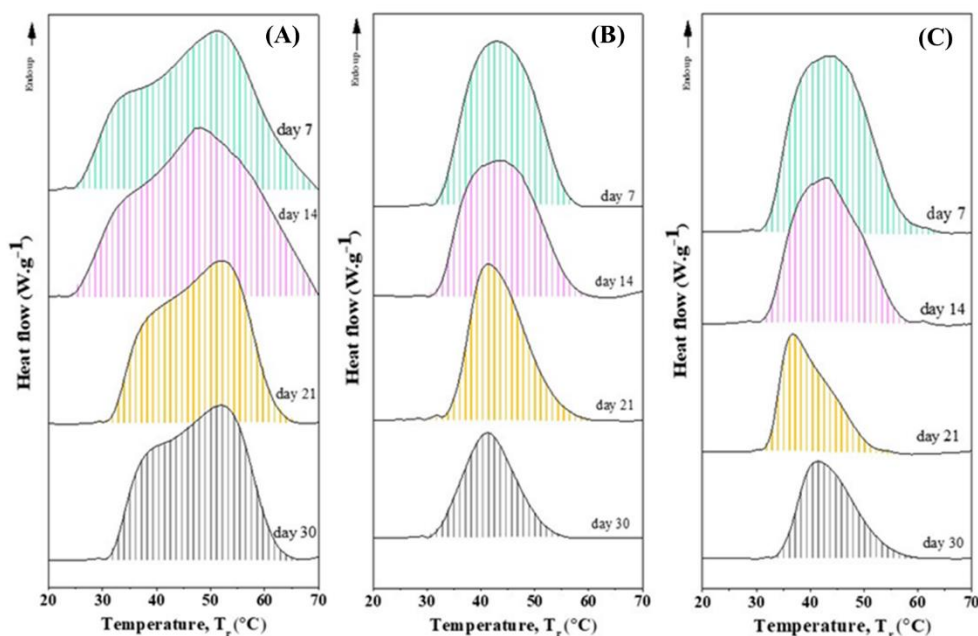

**Figure 51** DSC thermograms of creamed (A) sunflower, (B) longan and (C) wild honey stored in room temperatures

Enthalpy values  $\Delta H_m$ , (J/g), which were obtained by integrating the endothermic peaks, only provide information about the total amount of crystallized sugar but not the crystal dimensions. Figure 51 shows the change in enthalpy of crystal melting ( $\Delta H_m$ ) with storage time. The area under the peak or  $\Delta H_m$  of creamed sunflower honey slowly decreased at room temperature (Figure 49(A)). The reason from the enthalpy value is represents the amount of heat needed to melt crystals present in honey, when the amount of crystallized sugar decreased when the time increased, so the energy for using in melting the crystal decreased. This fact is consistent with the report of Lupano (1997): the enthalpy of polyfloral honey rapidly increased when it was stored at 4 and 10°C, whereas the samples stored at 20°C presented a slower increase. While, the peak of creamed longan and wild honey rapidly decreased in area and sharpened when the storage time increased at room temperature (Figures 51(B) – 51(C)). Similarly, creamed longan and wild honey appeared liquid during storage in room temperature, which implies that their consistency decreased when the storage time increased.  $\Delta H_m$  in creamed wild honey is 13.56 and 6.68 J/g on day 1 and day 30, respectively, which decreased when the storage time increased. This result is similar to the report of Zamora and Chirife (2006) and Costa *et al.* (2015), where the solubility of glucose increases and the tendency to crystallise is low when the temperature increases, and it explains the slow crystal growth in all types of honey at 25°C (Costa *et al.*, 2015; Nurul Zaizuliana *et al.*, 2017; Zamora and Chirife, 2006).

Therefore, after the product set to firm of creamed texture, all type of creamed honey product should avoid to keep in room temperature, the low temperature at 18-22°C or the supermarket's temperature is suitable storage condition and can guarantee the product shelf-life for more than 6 months without appearance variation as shown in Figure 52.

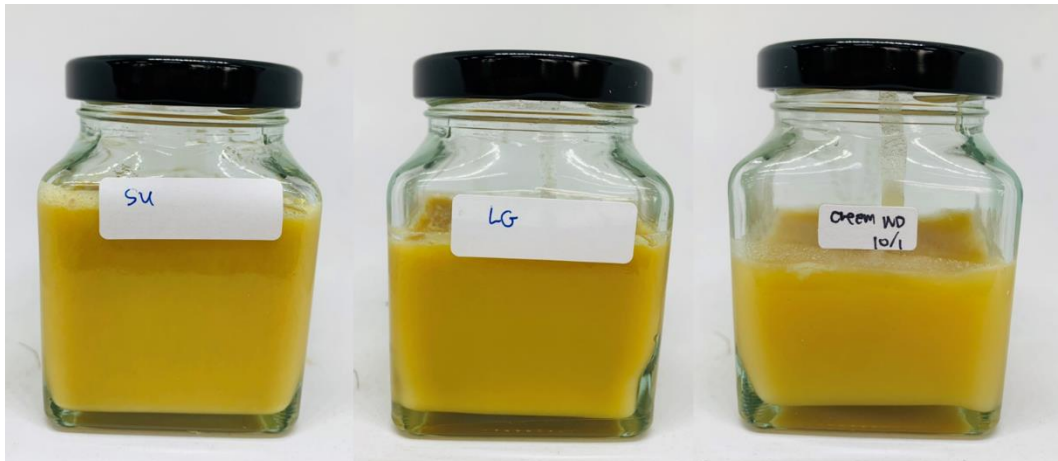

**Figure 52** Creamed honey product in 18-22°C in 6 months

#### 4.2.7 The conclusion of developed method of creamed honey product

The developed method of creamed honey which obtained from this research showed in process flow chart in Figure 53. Total processing time is 40 mins; starting from liquid honey is heated with ultrasonic treatment at 55°C for 30 mins and cooled rapidly with rate of 6.5°C/min to 20°C, seed honey is added following the G/W ratio of liquid honey. Then, rapid agitation <1,300 rpm for thoroughly mixing in chilled water for maintain the honey temperature below 20°C. Creamed honey is filled into glass bottle and treated with ultrasonic at 40 kHz for 5 mins in chilled water. Creamed honey product further stored in chilled temperature following the honey type (2 – 6 days) for obtaining a fine texture. Finally, the creamed honey should be place in low temperature (18-22°C) for conditioning, 1 day or until a soft texture results and making the creamed honey acceptable to consumers. The process flow chart of developed method and temperature profile were shown as Figure 53 and 54.

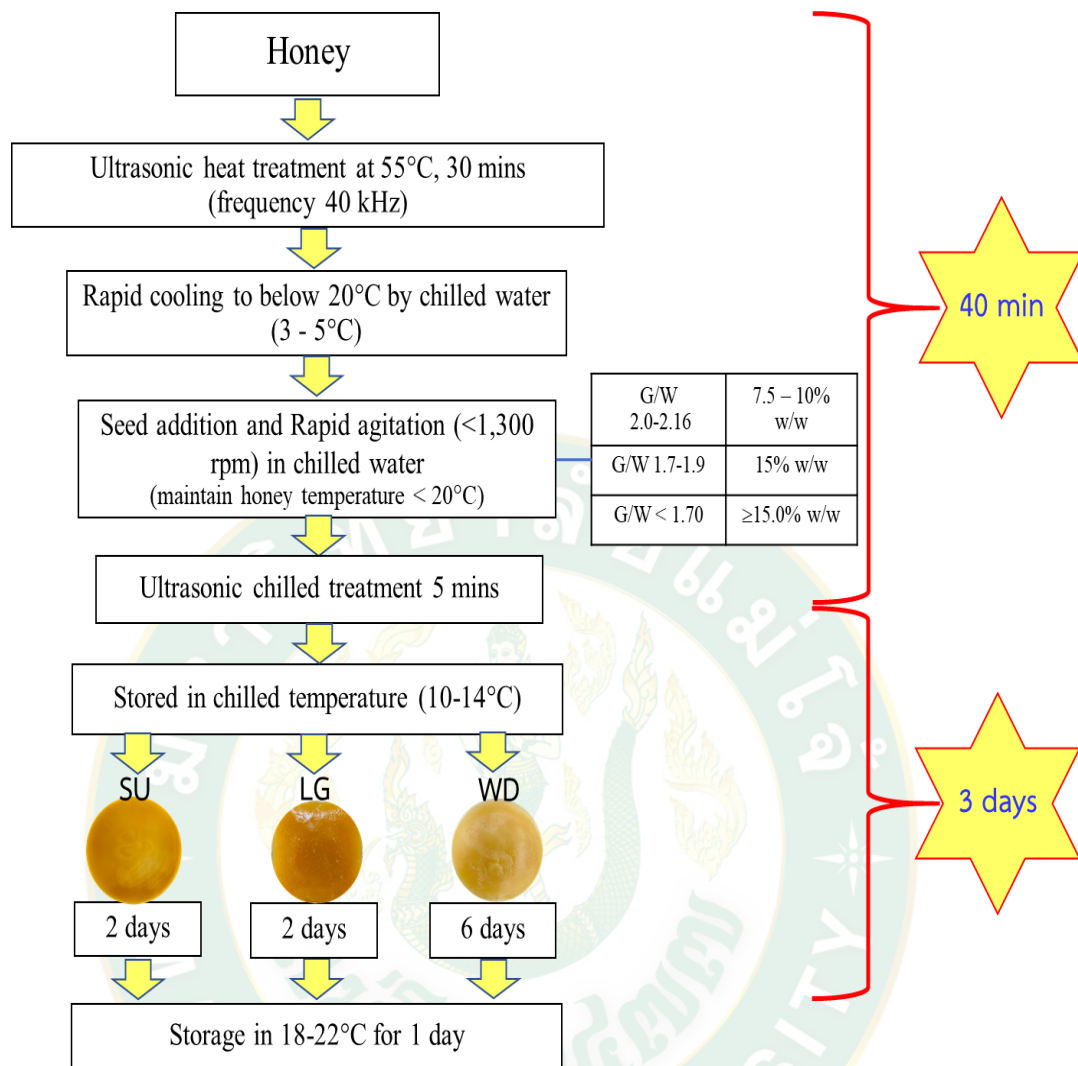
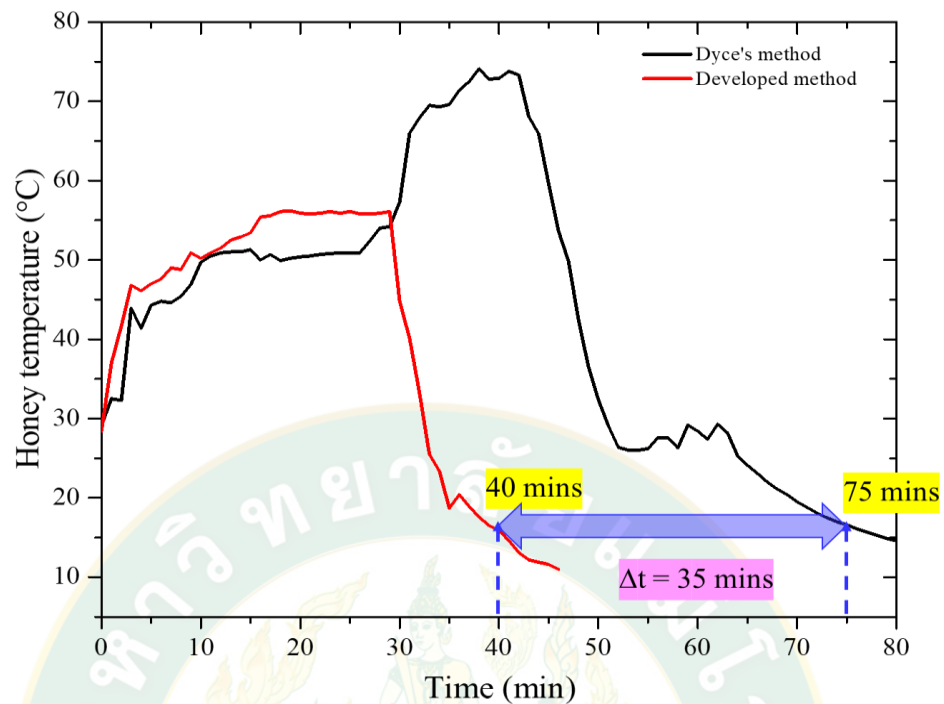

Figure 53 Developed process of Thai creamed honey product



**Figure 54** Temperature profile of creamed honey process comparing between developed method and Dyce's method

The result showed that the processing time without storage time is 75 mins and 40 mins for Dyce's method and developed method, respectively (Figure 54). It showed that the developed method could reduce the processing time into 35 mins especially in heating and cooling process. These solutions were result from the ultrasonic treatment, suitable seed addition, thoroughly mixing and very low temperature of chilled water, it can enhance in the part of heating honey temperature up and down in the short time. For comparing with Dyce's method, the total processing time concluded in Table 24. From the decreasing processing time in developed method, the process efficiency is 40%. Moreover, the storage time in chilled temperature and conditioning time were decrease from 19 days and increase the efficiency during storage is about 84.21% when comparing with Dyce's method.

**Table 24** Overall processing time comparing between Dyce's method and developed method

Processing step	Dyce's method	Developed method
Heating with ultrasonic time (min)	45	30
Cooling time (min)	20	5
Seed addition and agitation (min)	10	5
Ultrasonic post-treatment (min)	-	5
Total processing time (min)	75	45
Process efficiency (%)	40.00	
Time for firmness in chilled temperature (days)	4 - 6	2
Conditioning time (days)	14	1
Total storage time (day)	19	3
Product shelf-life (day)		
- 28 - 30°C	-	1 month
- 18 - 22°C	-	> 6 months

### 4.3 The crystallization model and improve the model to predict the crystallization behavior of creamed honey

#### 4.3.1 Crystallization model in crystallized honey induced with glucose powder

The bulk crystallization rate was calculated from the DSC isothermal crystallization curves. The area enclosed by a base line and exothermal peak corresponds to the heat of crystallization,  $\Delta H$ . The fraction of crystal ( $C$ ) at a given time ( $t$ ) was approximately by the ratio of the integration of the exothermal rate,  $\int \frac{d\Delta H(t)}{dt}$ , to the total area,  $\Delta H$ , in accordance with the following equation.

$$C = \frac{\left( \int_{t=0}^t \frac{d\Delta H(t)}{dt} \cdot dt \right)}{\Delta H} \quad \text{Eq. (39)}$$

The equation developed by Avrami (Avrami, 1939, 1940, 1941; Faleiros et al., 2000) was:

$$1 - C = \exp(-z \cdot t^n) \quad \text{Eq. (40)}$$

Where  $z$  = the rate constant of crystallization  
 $n$  = the constant defined in accordance with the mechanism of crystallization.

The relationship between  $z$  and  $n$  was derived from the mechanism of nucleation and the morphology of spherulite growth.

Eq. (40) can be converted to Eq. (41):

$$\log(-\log(1 - C)) = \log\left(\frac{z}{2.3}\right) + n \cdot \log t \quad \text{Eq. (41)}$$



The constant terms of  $\log\left(\frac{z}{2.3}\right)$  and  $n$  can be determined from a linear equation of the relationship between  $\log(-\log(1-C))$  and  $\log t$ . Therefore, as the relationship between  $C$  and  $t$  was calculated from the DSC isothermal crystallization curves of material.

As empirical model, the following power law equation has been applied as Eq. (42).

$$\frac{X_t}{X_0} = e^{\alpha t^\beta} \quad \text{Eq. (42)}$$

where  $X_t$  = the crystallized glucose fraction at time  $t$

$X_0$  = the crystallized glucose fraction at time 0

$t$  = time (days)

$\alpha$  = a rate parameter that defines an exponential growth or decline depending concavity

$\beta$  = 0 or 1, the equations describe a zero or first empirical order kinetic

**Table 25** First order parameters ( $\alpha$  and  $\beta$ ) and statistical parameters of crystallized honey resulted from adding glucose powder to liquid sunflower and longan honey.

Sample	Treatment	$\alpha$	$\beta$	$R^2$
Sunflower honey	Control	1.035	0.338	0.803
	1.0%	1.979	0.186	0.899
	1.5%	2.150	0.157	0.930
	2.0%	2.502	0.109	0.901
	2.5%	2.485	0.112	0.932
Longan honey	Control	0.657	0.317	0.924
	1.0%	1.257	0.261	0.961
	1.5%	1.855	0.159	0.974
	2.0%	2.004	0.141	0.979
	2.5%	1.981	0.130	0.979

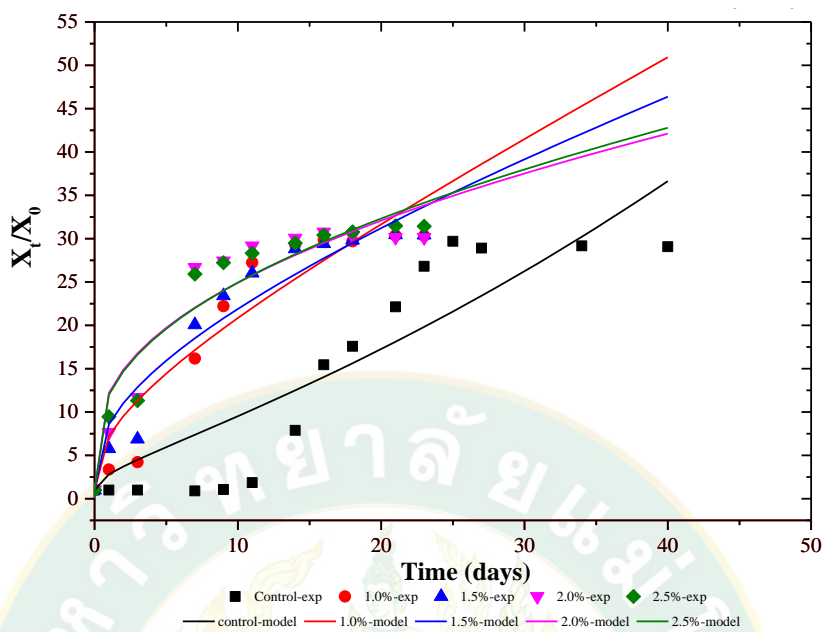

Figure 55 Experiment (exp) and modelled (model) data of  $X_t/X_0$  obtained with the empirical model of sunflower honey with glucose addition (%w/w)

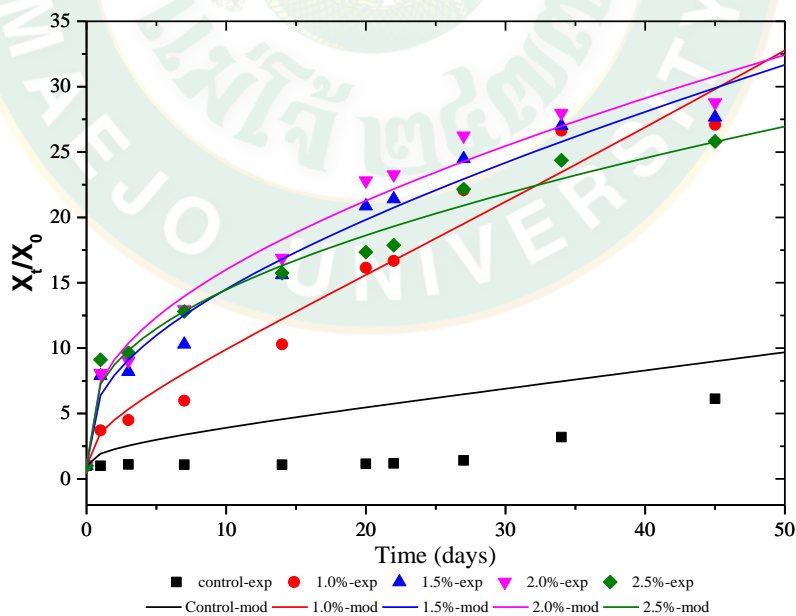

Figure 56 Experiment (exp) and modelled (model) data of  $X_t/X_0$  obtained with the empirical model of longan honey with glucose addition (%w/w)

The empirical model which is following power law equation has been found not suitable for describe the honey crystallization when induced with glucose addition in every treatment as shown in Figure 55 and 56.

The Avrami model has been applied for studying with kinetics of various sugars (Dettori et al., 2018) and found to be suitable for good describe with the enthalpy variation during crystallization. Therefore, it should study the behavior of honey crystallization. The Avrami equation was found to suitably describe the honey crystallization kinetics from DSC measurement during induced crystallization (Dettori et al., 2018), but has not applied the absorbance value at 660 nm. Conforti et al. (2006) and Lupano (1997) reported that turbidity measurement at 660 nm can be taken as an indicator of honey granulation. The increase in turbidity indicates the presence of more honey crystals. But there is a lack of study concerning honey crystallization kinetic, and further application in the design of creamed honey process.

To observe the crystallization behavior and compare the evolution of the crystallization process by using the Avrami model, the equation was simulated to find the value of the crystallization constant ( $k$ ) and Avrami index ( $n$ ). The fraction of crystals,  $C$  in Eq. (40) will converted into the relative crystallized fraction,  $X(t)$ . The maximum value of absorbance at 660 nm ( $A_{660_{\max}}$ ) in each treatment was considered as the relative crystallized fraction, or  $X$  as 1. We considered an increase of the relative crystallized fraction,  $X(t)$ , during storage, Eq. (40) converted into Eq. (43)

$$X(t) = \frac{A_{660}}{A_{660_{\max}}} \quad \text{Eq. (43)}$$

Where:  $A_{660}$  = the absorbance wavelength at 660 nm at any time ( $t$ )  
 $A_{660_{\max}}$  = the absorbance wavelength at 660 nm at a maximum value of any treatment.

$X(t)$  = the relative crystallized glucose fraction at the time ( $t$ )

The Avrami equation (Avrami, 1939) describes the proportion of crystals presented at time ( $t$ ) compared with glucose crystals in full crystallization time, and take Eq. (43) into Eq. (40), the crystallization kinetic can simulated into Eq. (44).

$$X(t) = 1 - \text{EXP}[-k(t^n)] \quad \in [0,1] \quad \text{Eq. (44)}$$

Where:  $k$  = rate constant of crystallization process

$n$  = Avrami index, a parameter characteristic of nucleation and growth mechanisms of the crystals.

From part 4.1.2 which studied the effect of glucose addition in different honey type of longan and sunflower honey. The experimental data showed in the absorbance value at 660 nm related with the crystallization time. Therefore, in this part will find the suitable model for describing the crystallization behavior in each honey type. The experimental data and corresponding fitted model of both honey samples to find the  $k$  and  $n$  values in different glucose addition and the results showed in Figure 57 - 58.

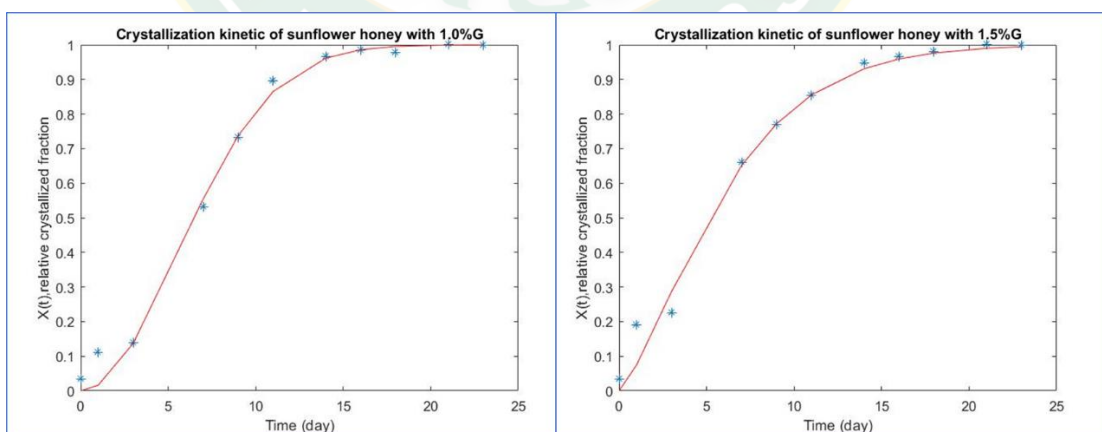

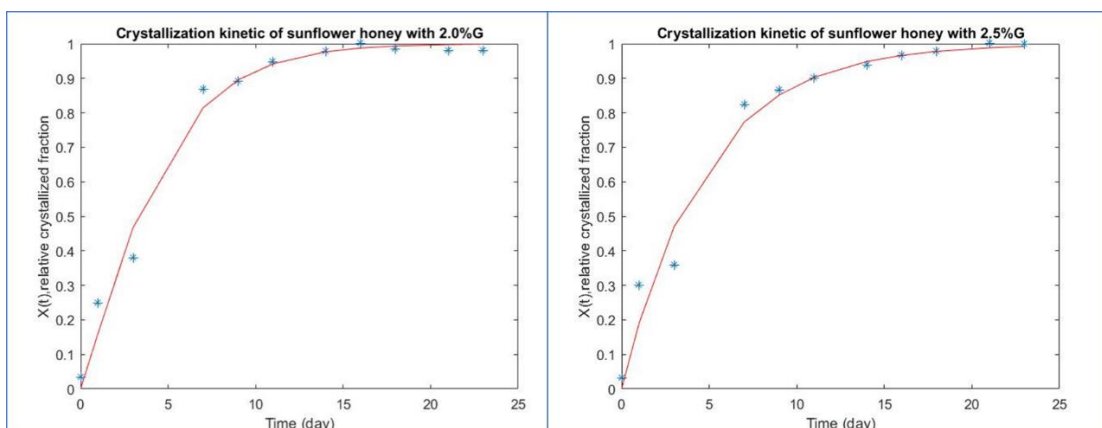

Figure 57 Nonlinear regression for crystallization kinetic from Avrami equation by MATLAB program (sunflower honey)

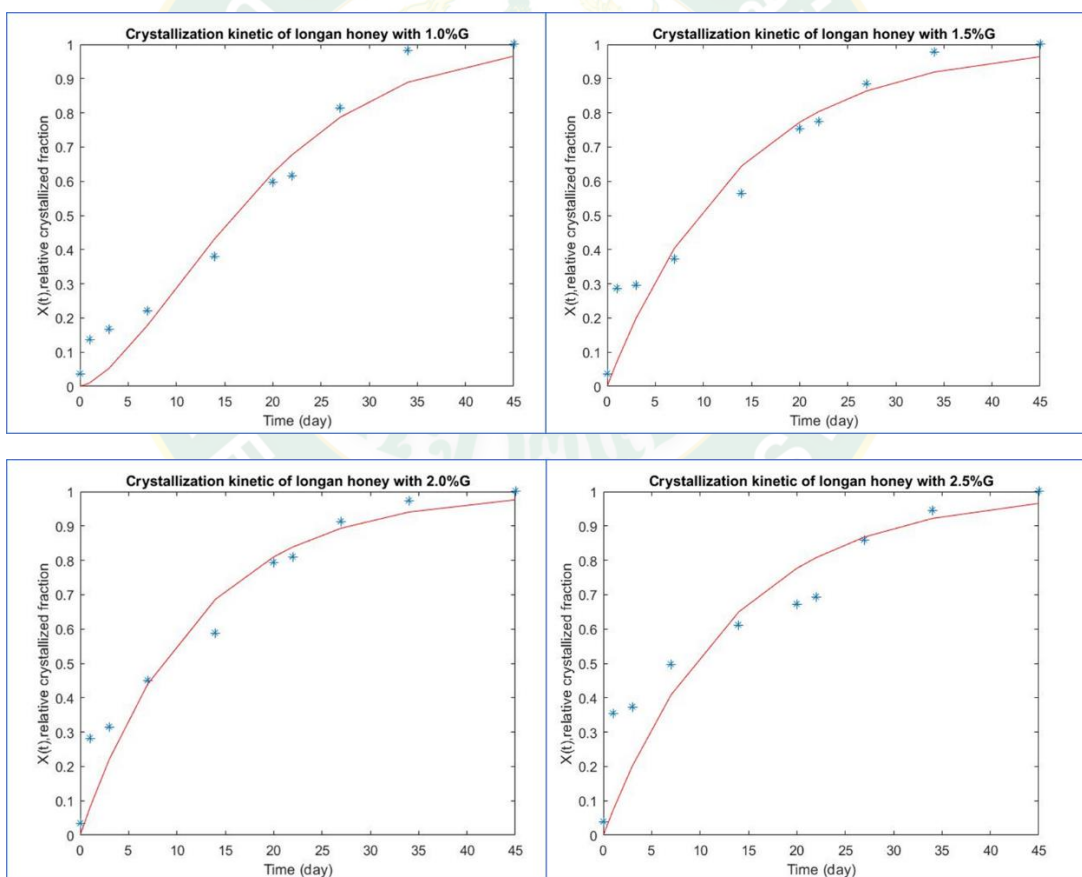
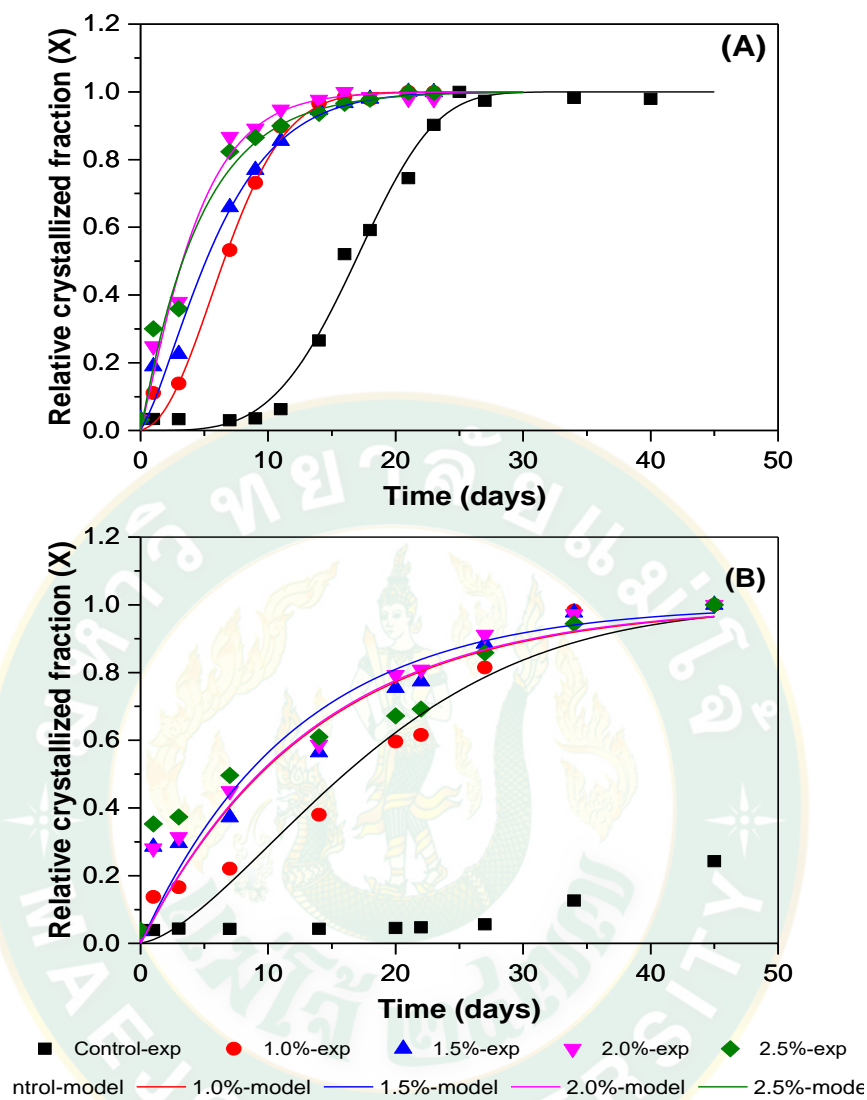

Figure 58 Nonlinear regression for crystallization kinetic from Avrami equation by MATLAB program (longan honey)

The turbidity of honey increased, when the crystallization time increased as shown in Figure 57-58. The intensity of absorbance at 660 nm has been carried out to monitor increases of glucose crystal in honey samples during storage at chilling temperature. The results showed that we could accelerate crystallization by adding glucose powder into both samples. When absorbance or turbidity was increased, the crystallization rate increased with non-linear characteristics. It rapidly increased in the initial phase. At close to full crystallization, the curve continued, particularly in sunflower honey. These results are consistent with a study by Lupano (1997).

The rate of crystallization for all treatments in sunflower honey was not linear but seemed to be characterized by an initial fast phase followed by a slower one, as shown in Figure 59(A).

The slope of the crystallization rate plot of sunflower honey was greater after being induced with glucose powder. However, the slope became static when honey samples reached full crystallization, or the nuclei were in the growth phase (Figure 54(A)). Similar behavior was observed by Venir et al. (2010). The statistical parameter ( $R^2$ ) of the Avrami model were used to compare between two types of creamed honey. The higher the  $R^2$ , the better it fitted with the model and the calculated parameters obtained by modelling the absorbance data with the Avrami model (Table 24). The statistical parameters of the Avrami model are suitable to describe the crystallization kinetics.  $R^2$  values were high (0.818 – 0.992) in both honey samples, except for the control sample. This is similar to the Avrami equation used to monitor the crystallization kinetics of liquid honey with fine crystals added at 14°C to increase the crystallization rate, which presented  $R^2$  values in the range of 0.924 – 0.931 (Dettori et al., 2018).



**Figure 59** Experiment (exp) and modeled (model) data of relative crystallized fraction  $X(t)$  obtained with the Avrami equation of, (A) sunflower honey and, (B) longan honey with glucose addition (%w/w).

The crystallization constant ( $k$ ) increased with the increase in glucose powder. When we added glucose powder at only 1.0% (w/w), the constant  $k$  ( $0.016$ ) was higher than the sample without glucose addition ( $1.082 \times 10^{-5}$ ). The highest value ( $0.212$ ) was obtained in sunflower honey with 2.5% (w/w). This confirmed that the crystallization rate could be accelerated by increasing the glucose content. Dettori et

al. (2018) reported that the rate constant decreased with an increase of F/G ratio or reduced glucose. Present data support this behavior. When honey reaches the supersaturation level in the first phase, the nucleation rate is high.

**Table 26** Avrami parameters ( $k$  and  $n$ ) with standard deviation (S.D.) and statistical parameters of crystallized honey resulted from adding glucose powder; 1.0, 1.5, 2.0, and 2.5 (%w/w) to liquid sunflower and longan honey.

Sample	Treatment	Equation	$k$	$n$	$R^2$
Sunflower honey	Control	$X = 1 - EXP(-1.082 \times 10^{-5} t^{3.919})$	$1.082 \times 10^{-5} \pm 0.000$	$3.919 \pm 0.307$	0.991
	1.0%	$X = 1 - EXP(-0.016 t^{2.01})$	$0.016 \pm 0.007$	$2.010 \pm 0.196$	0.992
	1.5%	$X = 1 - EXP(-0.078 t^{1.341})$	$0.078 \pm 0.022$	$1.341 \pm 0.133$	0.986
	2.0%	$X = 1 - EXP(-0.177 t^{1.159})$	$0.177 \pm 0.038$	$1.159 \pm 0.123$	0.984
	2.5%	$X = 1 - EXP(-0.212 t)$	$0.212 \pm 0.048$	$1.000 \pm 0.117$	0.976
Longan honey	Control	-	-	-	-
	1.0%	$X = 1 - EXP(-0.01 t^{1.529})$	$0.010 \pm 0.008$	$1.529 \pm 0.267$	0.956
	1.5%	$X = 1 - EXP(-0.074 t)$	$0.074 \pm 0.038$	$1.000 \pm 0.182$	0.930
	2.0%	$X = 1 - EXP(-0.083 t)$	$0.083 \pm 0.039$	$1.000 \pm 0.172$	0.937
	2.5%	$X = 1 - EXP(-0.075 t)$	$0.075 \pm 0.055$	$1.000 \pm 0.261$	0.818

According to this result, Avrami index or  $n$  values of sunflower honey (1.000 – 3.919) were higher than those of longan honey (1.000 – 1.529). This could explain that the crystal formation time of longan honey is longer than that of sunflower honey. Moreover, the value of  $n$  showed in range of 1.0 – 4.0 which is represent in the shape of crystal in pentagonal and hexagonal which is similar as shown in Figure 34. Therefore, the Avrami model is a very appropriate model for describing the crystallization behavior from the intensity of absorbance values at 660 nm in sunflower and longan honey under the condition of glucose addition. However, for further apply with another honey type or any conditions, the relationship between the rate constant ( $k$ ), Avrami index ( $n$ ) and parameters of honey properties such as moisture content, initial concentration of sugar in honey, water activity; should be further considered.



#### 4.3.2 Crystallization model in creamed honey with ultrasonic treatment

The Avrami equation has never been applied to model honey crystallization kinetic of Thai creamed honey for giving useful information about the crystallization mechanisms. So, the absorbance values were monitored of creamed sunflower, longan and wild honey after seed addition until firmness setting by variation of seed addition. The refractive of crystallized fraction or  $X(t)$  obtained by Avrami equation and showed in each creamed honey type as in Figure 60.

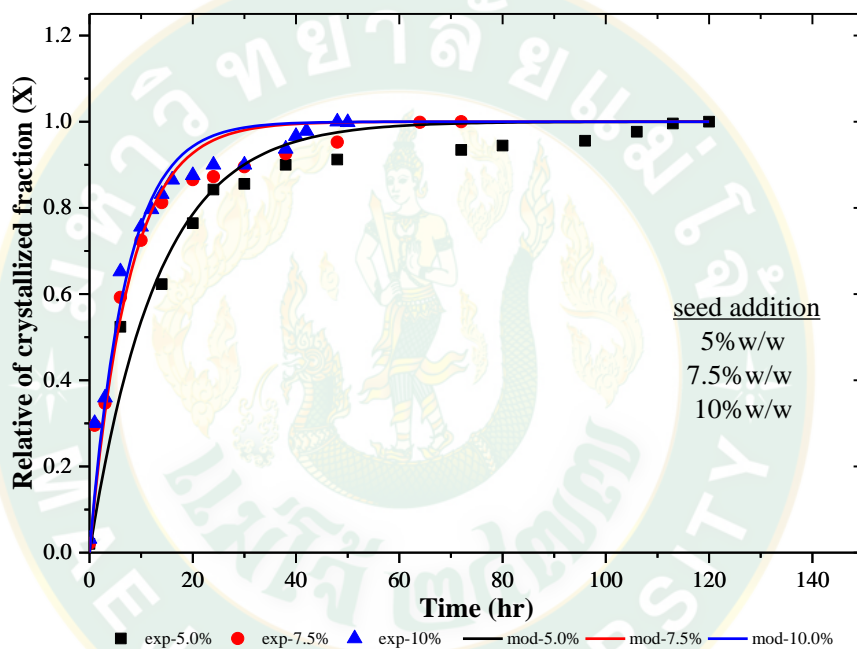

(A) creamed sunflower honey

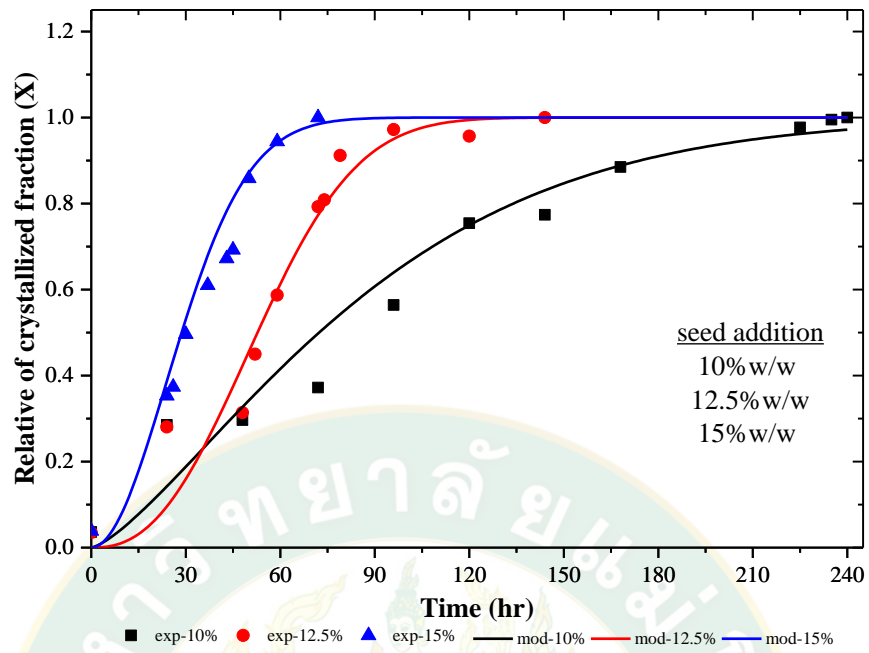

(B) creamed longan honey

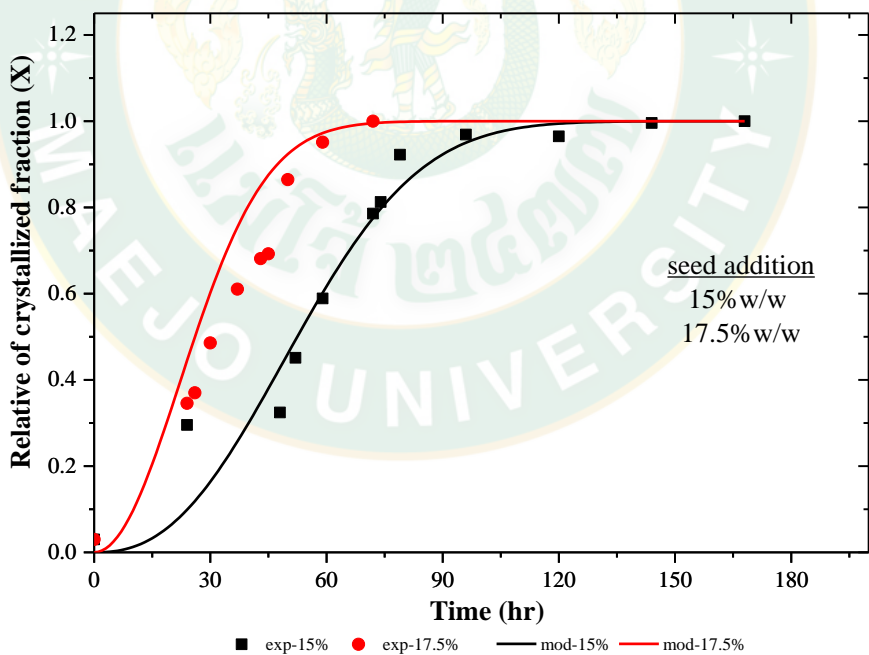

(C) creamed wild honey

**Figure 60** Experiment (exp) and modeled (mod) data of relative crystallized fraction  $X(t)$  obtained with the Avrami equation of Thai creamed honey

The statistical parameter ( $R^2$ ) of the Avrami model were used to satisfying of suitable model of creamed honey. The  $R^2$  of all creamed honey samples were higher than 0.90, the better it fitted with the model and the calculated parameters obtained by modelling the absorbance data with the Avrami model (Table 27). The statistical parameters of the Avrami model are suitable to describe the crystallization kinetics of creamed honey production with ultrasonic treatment.  $R^2$  values were high (0.949 – 0.986) in all creamed honey samples. This equation was simulated by assumption of creamed sunflower, longan and wild honey production with control of crystallization process with ultrasonic as post-treatment at frequency 40 kHz, intensity of 0.15 W/cm<sup>2</sup>. The useful of mathematical model is further applied for operate in creamed honey maker which will report in next part.

**Table 27** Avrami parameters ( $k$  and  $n$ ) and statistical parameters of creamed sunflower, longan and wild honey resulted from seed honey addition (5.0% - 17.5%w/w).

Sample	%seed honey addition	Equation	$k$	$n$	$R^2$
Creamed sunflower honey	5.0%	$X = 1 - EXP(-0.007t)$	0.077	1.000	0.953
	7.5%	$X = 1 - EXP(-0.131t)$	0.131	1.000	0.949
	10.0%	$X = 1 - EXP(-0.143t)$	0.143	1.000	0.952
Creamed longan honey	10.0%	$X = 1 - EXP(-0.002t^{1.366})$	0.002	1.366	0.963
	12.5%	$X = 1 - EXP(-4.211 \times 10^{-5} t^{2.448})$	$4.211 \times 10^{-5}$	2.448	0.950
	15.0%	$X = 1 - EXP(-0.001t^{1.949})$	0.001	1.949	0.984
Creamed wild honey	15.0%	$X = 1 - EXP(-4.735 \times 10^{-5} t^{2.422})$	$4.735 \times 10^{-5}$	2.422	0.951
	17.5%	$X = 1 - EXP(-0.001t^{2.007})$	0.001	2.007	0.986

Therefore, the Avrami model is a very appropriate model for describing the crystallization behavior from the intensity of absorbance values at 660 nm in Thai creamed honey under the condition of ultrasonic treatment at 40 kHz, intensity of 0.15 W/cm<sup>2</sup> during chilled water for 5 mins. This model can further use to predict the operation time of creamed honey maker by automatic controlling system in next part. However, the ultrasonic intensity and temperature variation for simulating with the Avrami model should be further studied.

#### **4.4 Food engineering innovation concept design**

##### **4.4.1 Food innovation concept design**

Food process design is somewhat different from other design processes. The main focus is not solely on process improvement but has a strong relation to product development, quality, and sensory attributes. Because of the variety and complexity of modern processes, it is not possible for one person to remember very single process involved. Each process is divided into a series of steps, called operations. Further, individual operations utilize common techniques based on similar scientific principles. Thus, a food processing system can be divided into a number of unit operations in order to develop a product with desired quality and safety attributes. A number of steps are involved comprise the complete process. The unit operations describe the details of each step or operation in the complete process (Rahman and Ahmed, 2012).

The process variables comprise two types, one due to the material (intrinsic), the other due to the system (extrinsic). Similar to in creamed honey process, the selected variable can be listed as mass of liquid honey, honey properties, initial honey temperature, surrounding temperature, heating and cooling condition, mass of seed honey, until the storage condition. Moreover, we need to know processing time and conditions,  $t = f(\text{variables})$ , mainly in order to decide how long to process the product.

The design of creamed honey maker will be scaling up from lab scale (0.5 – 1.0 liters) into 100 – 150 liters which using ultrasonic with agitating device to produce the best texture of creamed honey product. The knowledge of hygienic design will

apply to design creamed honey maker in this section. The expected of this prototype is simpler, less equipment and more efficient than traditional method. The designing is considered by relate to the controlling of temperature and crystallization process with the following.

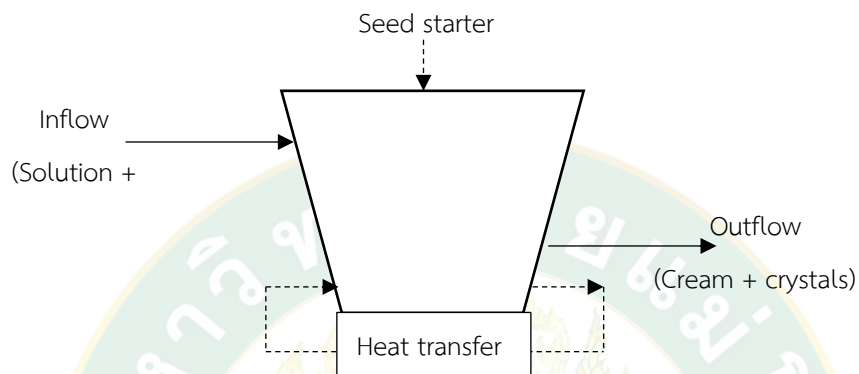

**Figure 61** Creamed honey process

**Source:** adapted from Thirawat (2012)

From the comparative process flow diagram as shown in Figure 62, it shows that the Dyce's method taken the long processing time when compared with the developed process. The developed method is more efficient, it just took time about 40 mins for processing time and took only 2 days for obtained a creamy texture.

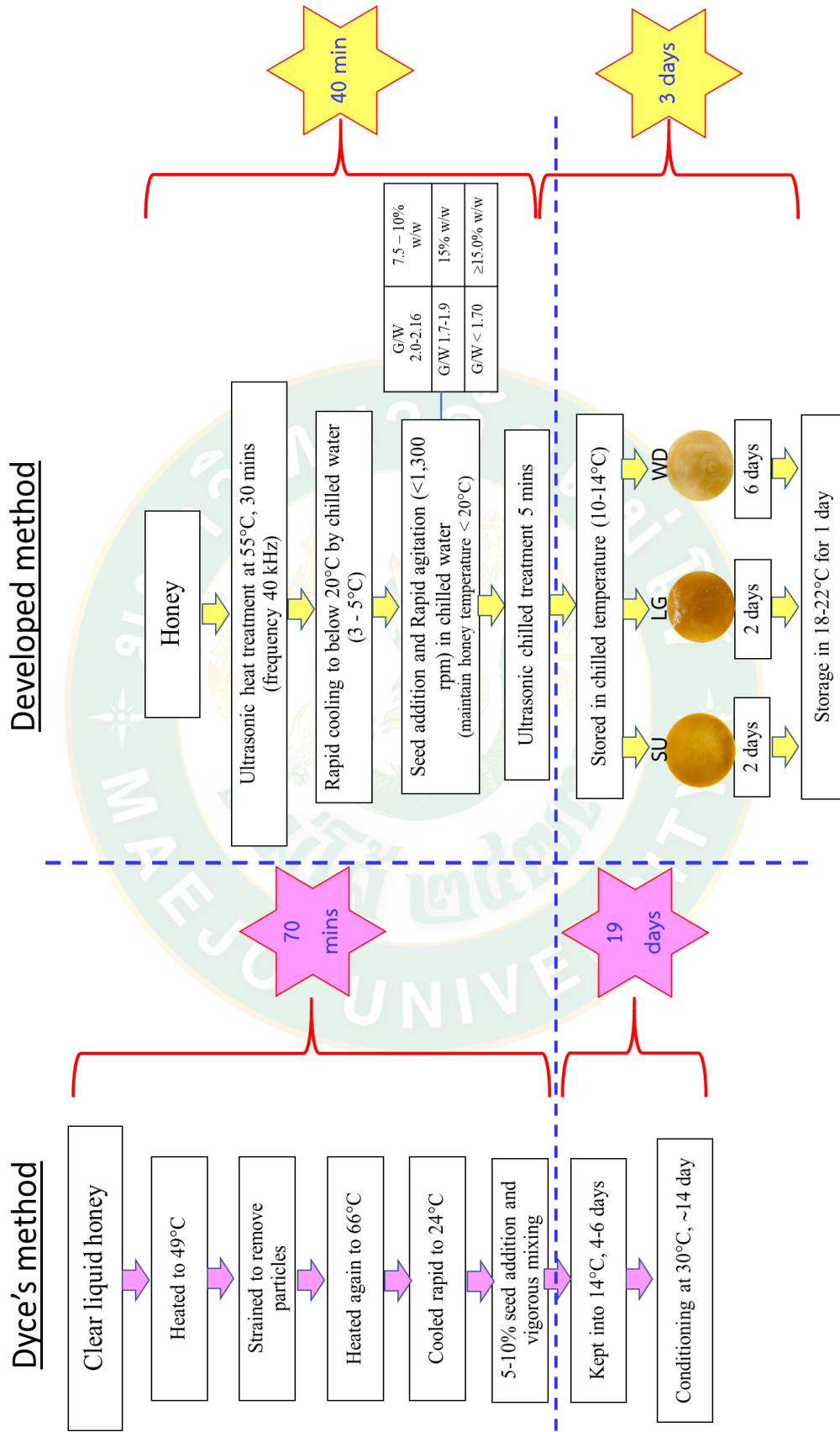
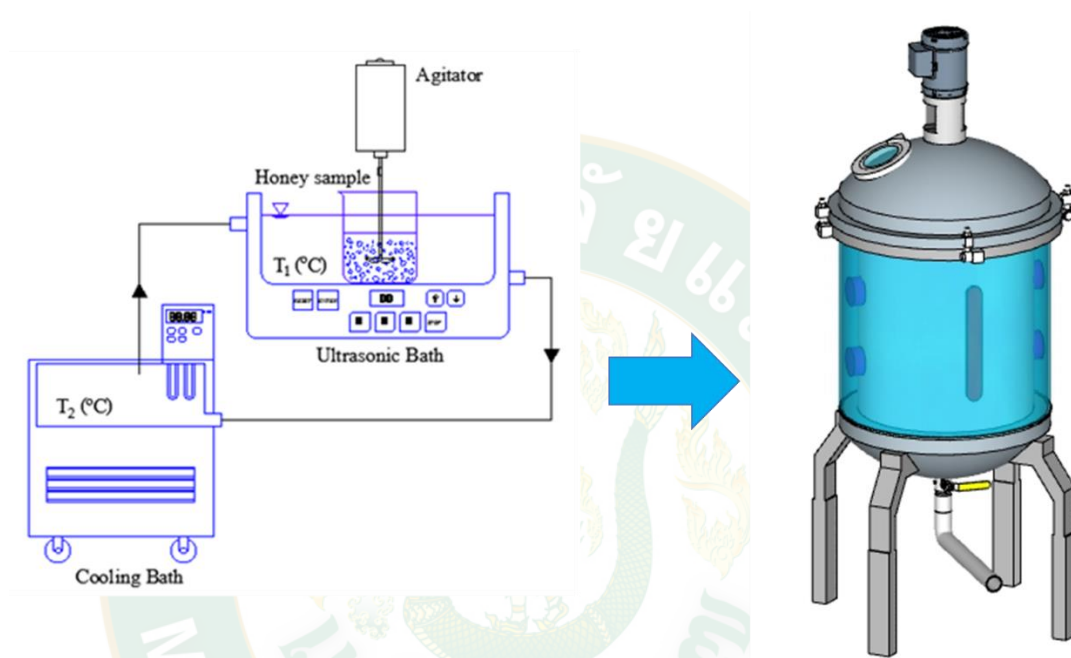

Figure 62 Comparative of creamed honey process between Dyce's method and developed method

Creamed honey maker will design following the desired process from part 4.2 and designed this machine to produce the product in bulk for 100 L size. The schematic diagram of creamed honey process was modified from lab scale to scale up as 100 L which was suitable with SME of honey industry as shown in Figure 63.



**Figure 63** The creamed honey process from lab-scale to 100 L creamed honey machine prototype model

The creamed honey maker has design under the concept of set with a special mechanical stirrer that allows you to carry out the recrystallization process, after which honey will obtain an ideal "spreading" consistency, similar to chocolate creams for children. This process involves cyclical aeration and intensive mixing of honey for several days until the right consistency is achieved. Aeration occurs during mixing.

The creamed honey maker will mix the seed honey and liquid honey on a programmed schedule with a heavy duty, variable speed AC motor. The resulting product is beautiful light creamed honey with the texture of butter. Liquid honey will heat with ultrasonic processor for pasteurization process, then the honey needs to be rapid cool ( $3 - 5^{\circ}\text{C}$ ) to below  $20^{\circ}\text{C}$ . A seed honey is then added to make up 7.5 –

15% (depends on the honey type) of the batch. The seed honey can be from a previous batch, or from a special handmade batch which provides the desired crystalline size and shape, and therefore texture. The agitating action evenly distributes the seed crystals throughout the honey, creating uniformly creamed honey. Agitating can pass agitating devices with motor drive.

Impeller for highly viscous liquids, for viscosities above 20 Pa.s, the helical-ribbon impeller is often more effective. The diameter of the helix is very close to the inside diameter of the tank, guaranteeing liquid motion all the way to the tank wall even with very viscous materials. To provide good agitation near the floor of the tank, an anchor impeller may be used. Because it creates no vertical motion, it is a less effective mixer than a helical ribbon, but it promotes good heat transfer to or from the vessel wall. For this purpose, both anchors and helical ribbons may be equipped with scrapers that physically remove liquid from the tank wall (McCabe, W. L., et al., 2005)

Bottling creamed honey into a package by opening it through the cork. The product will be keeping in refrigerator for firm texture and place in low temperature (18-22°C) for conditioning. Soft texture in creamed honey will ready to sale on shelf and can keep for at least 6 months with product stability.

The ultrasonic systems of this machine are categorized as ultrasonic bath, the transducers are fixed to the underside of the tank, operated at 40 kHz frequency, and the ultrasonic energy is directly delivered to the liquid in the tank. Further, these are low power systems because the volume of liquid in the tank is large. Due to the presence of standing waves produced by the reflection of sound waves at the liquid-air interface separated by the distances equivalent to the half wave lengths, high intensities are achieved at fixed levels in the bath.

To design the ultrasonic tank, system design includes the determination of appropriate ultrasonic power requirements and the number of transducers to be used in the tank for maximum effectiveness. The tank volume and shape are the consideration factor in the calculation. The most common tank used is a deep drawn



tank, the tank comes in a range of the size (L x W x H) from about 5 x 5 x 5 inch to 19 x 23 x 33 inch. The recommendation of the design tank is the number of sizes available and the second type of tank commonly used is a heavy gauge stainless steel of either 304 or 316L grade.

Most of the industrial ultrasonic systems use watt density from 50 – 100 Watts per gallon (1 Gallon = 3.78 L). To design the ultrasonic tank, the average power requirement for 100 L was calculated, information review the tank size of 100 L usually design as 19 x 33 inch (D x H). Then, the ultrasonic power requirement for tank was calculated by the followed equation (TM Associates, 2018).

$$\text{Average Watts of ultrasonic power} = \frac{L \times W \times H}{231} \times 100 \quad \text{Eq. (45)}$$

The creamed tank is the cylindrical shape, so Eq. (47) will modify into Eq. (48).

$$\text{Average Watts of ultrasonic power} = \frac{\pi \times R^2 \times H}{231} \times 100 \quad \text{Eq. (46)}$$

Thus, the power requirement of tank size was 3,682.20 Watts, and the ultrasonic power selection should be in the range of 3,000 – 4,000 Watts. The chamber was used stainless steel of 316SUS grade. The ultrasonic tank includes 4 ultrasonic transducers and 200 W of aluminium heating plates cover a temperature range up to 150°C. The heating plates can handle extreme pressure loads and are impact and vibration resistant. Their shapes can be individually fabricated whether round shaped.

Chill cooler system is related voltage at 220 V, frequency 50/60 Hz. Stable cooling tank is 100 L and flow to circulate outer of creamed honey tank with pump. Stable cooling tanks are indispensable for the production of high quality and bacteriologically safe creamed honey. It can cool the liquid honey with the water

from the system. Compressor power is 275 Watt and temperature range in 4 – 8°C and cooling rate at 6.5°C/min

Automation control system achieved the creamed honey maker following the process condition including heating temperature, ultrasonic time, cooling temperature and process running time in each machine run. Honey temperature were checked and showed the actual value through machine work on.

In all models the agitating and stirring of the honey is done with a perfectly fitted paddle screw with a very solid shaft. Creamed honey for 100 L or more has in addition to the paddle a rake part at the bottom, center and top of tank for homogeneous mixing. This rake part gets to every bit of honey in the tank and prevents crystallization on the tank wall or bottom. It moves the honey from the bottom to the top so no air can be trapped. During operation it will create a circulating stream which mixes and stirs the honey thoroughly even when working only for short cycles. The paddle scrap works without an end support bearing and therefore no contamination with bearing grim can occur. Make sure there was at least 50 mm between the end of the paddle and the sides of the tank. The overview of schematic diagram of creamed honey maker model prototype showed in Figure 64 - 67.

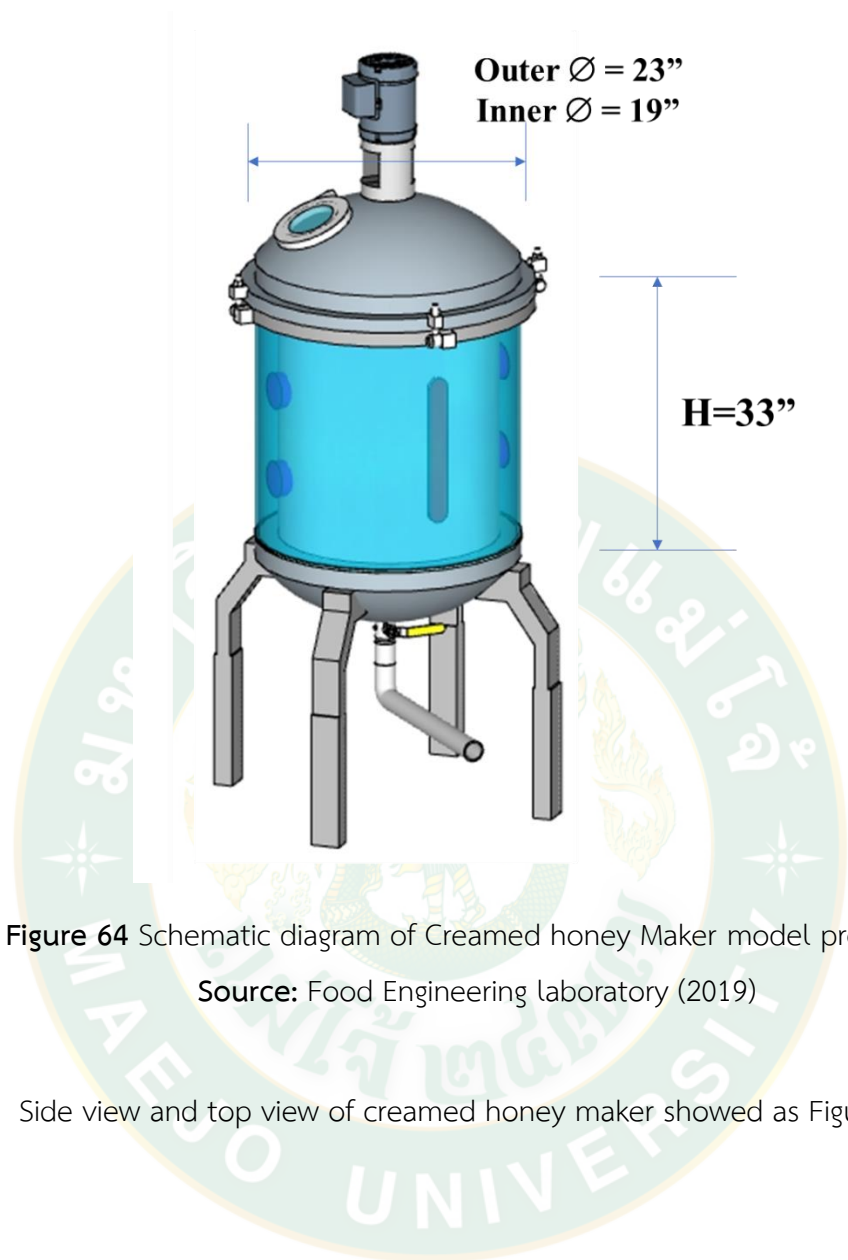

**Figure 64** Schematic diagram of Creamed honey Maker model prototype

**Source:** Food Engineering laboratory (2019)

Side view and top view of creamed honey maker showed as Figure 68 – 70.

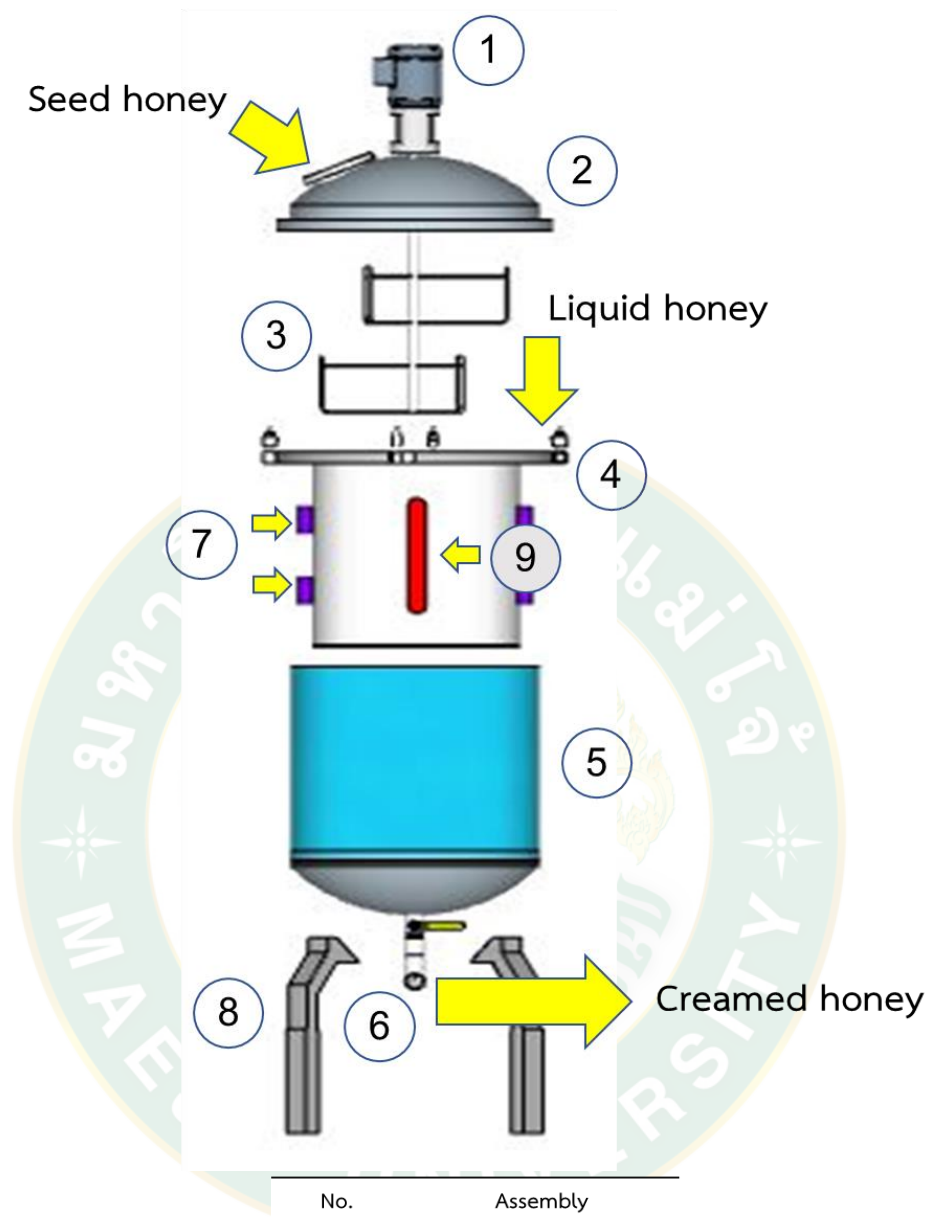
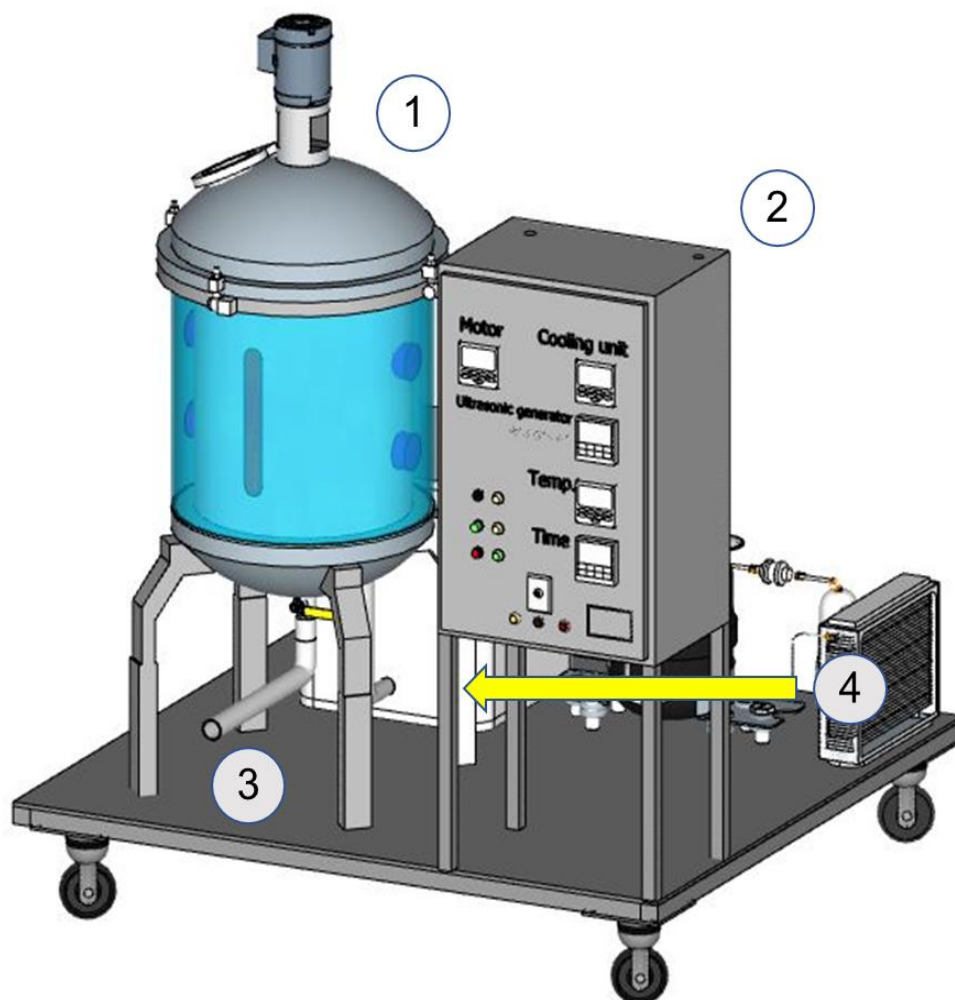
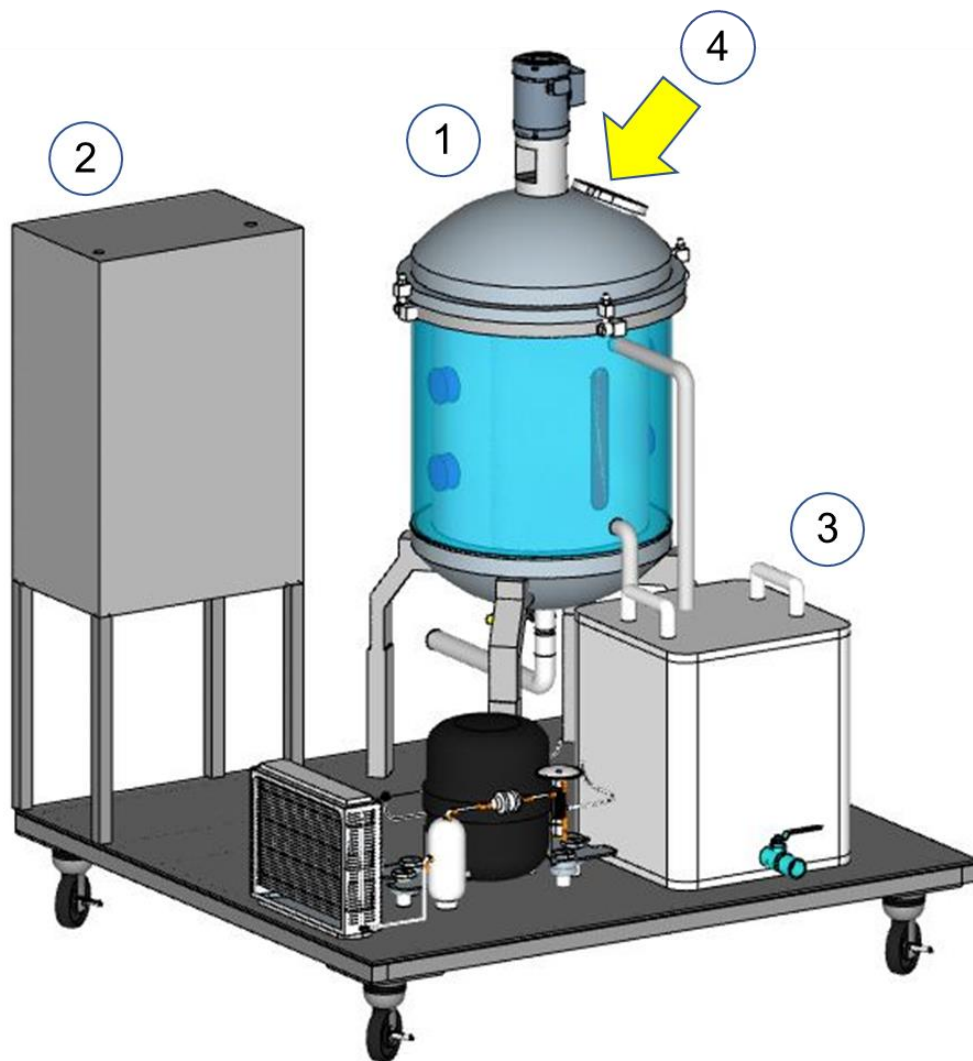

Figure 65 Assembly view of creamed honey maker (Tank)



No.	Assembly
1	Creamed honey maker tank
2	Control box
3	Product out
4	Cooling system

Figure 66 Assembly view of creamed honey maker (Overall view)



No.	Assembly
1	Creamed honey maker tank
2	Control box
3	Stable cooling tank
4	Seed addition incoming

**Figure 67** Assembly view of creamed honey maker (Back view)

Technical details:

- Tank inner  $\varnothing$  19 inch, tank outer  $\varnothing$  21 inch and tank height 33 inch. Total height 37 inch. Tank and agitating device made of 316 stainless steel.
- The ultrasonic tank includes 4 ultrasonic transducers and power 3,000-4,000 Watts and 200 W of heater plates.
- The chilled water cooler tank used power consumption in 275 Watts and 220 V. Chilled water tank is 100 L and flow to circulate outer of creamed honey tank with pump. Compressor power is 275 Watt and temperature range in 4 – 8°C and cooling rate at 6.5°C/min
- Flat gear motor 250 W / 220 V. The motor is designed for continuous duty. Motor is fully enclosed and moisture resistant.
- The impeller blades are food grade 316 stainless steel, 18 inch blade wide, angled at 30 degrees. Construction of the mixing blade allows creamed honey precisely.
- The shaft is milled  $\frac{3}{4}$ " at the center point, to allow blade adjustment, up or down.
- All fitting and shaft are stainless steel.
- All parts including the motor channel and mount are made of food grade materials.

For the evaluation step task, the relative activities topic includes hygienic design, food safety standard requirement. The hygienic design was scope only in hygienic design in equipment. Cleaning-In-Place (CIP) and Sterilization-In-Place (SIP) are used to the cleaning system for automatic cleaning and disinfecting without major disassembly and assembly work. We designed, develop, manufactured, supply and installed CIP and SIP Units for sanitization and sterilization. The units are custom made, modular, skidded in automated or semi-automated models as per the required time cycle for cleaning and sterilization as a part of cGMP requirements.

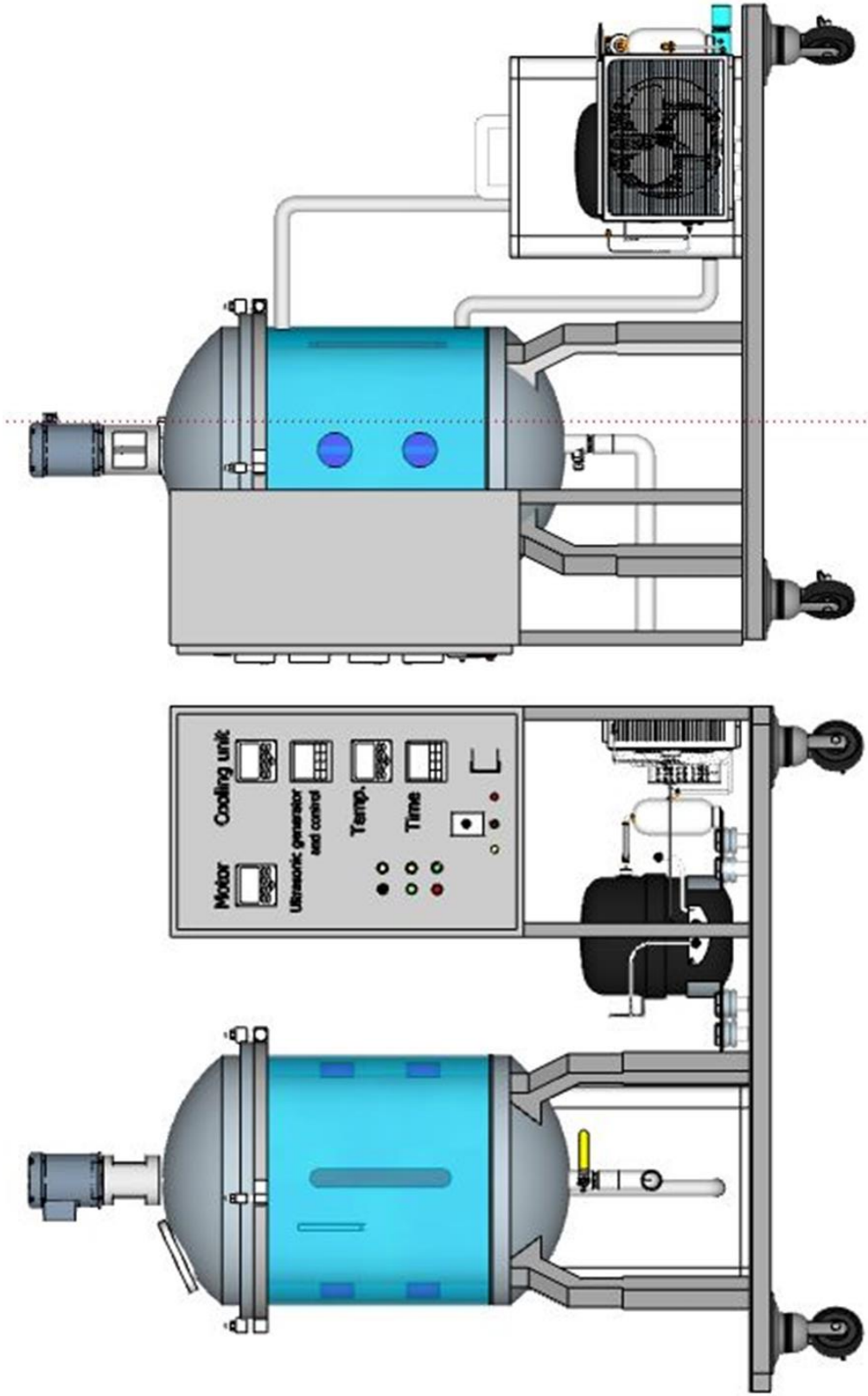

Figure 68 Assembly view of creamed honey maker (side view-1)



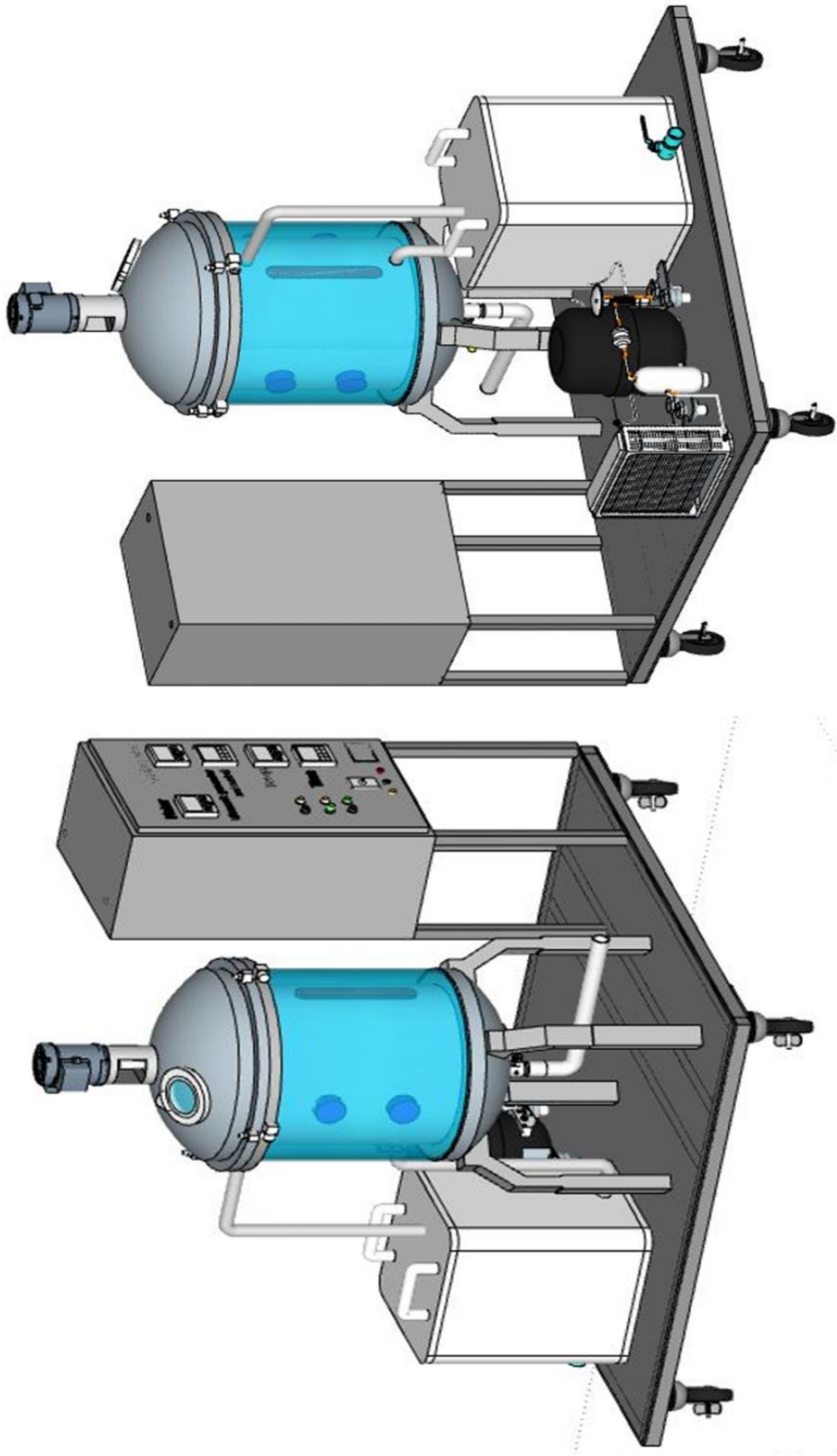
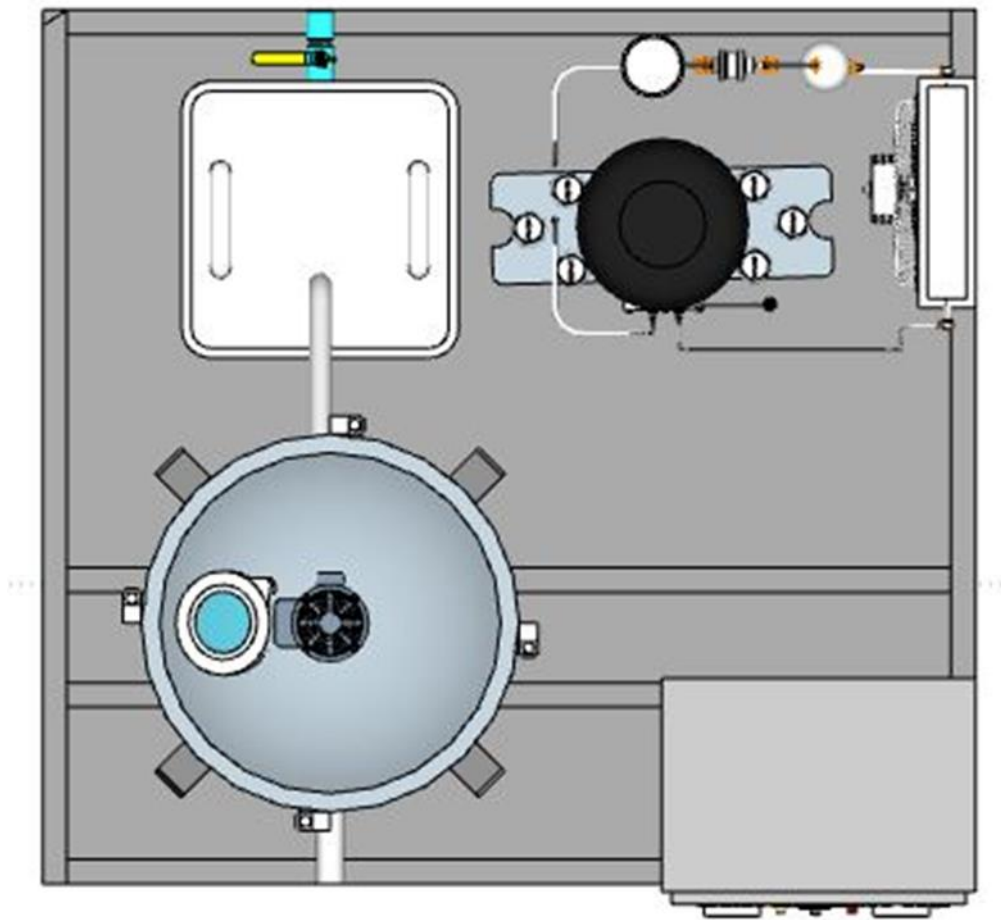

Figure 69 Assembly view of creamed honey maker (side view-2)



**Figure 70** Assembly view of creamed honey maker (Top view)

Good creamed honey should have consistence similar to butter, so automatic control for creamed honey maker should be set up.

The Graphic User Interface (GUI) was created with the simulation MATLAB script to set the automation program to operation process of creamed honey maker. The boundary condition was including the temperature of heating with ultrasonic at  $55^{\circ}\text{C}$  and cooling condition because it is an optimal temperature for production of creamed honey product. The amount of raw material and the G/W ratio of honey were input parameters for further calculated the amount of suitable seed honey addition, product yield percentage and storage time in refrigerator.

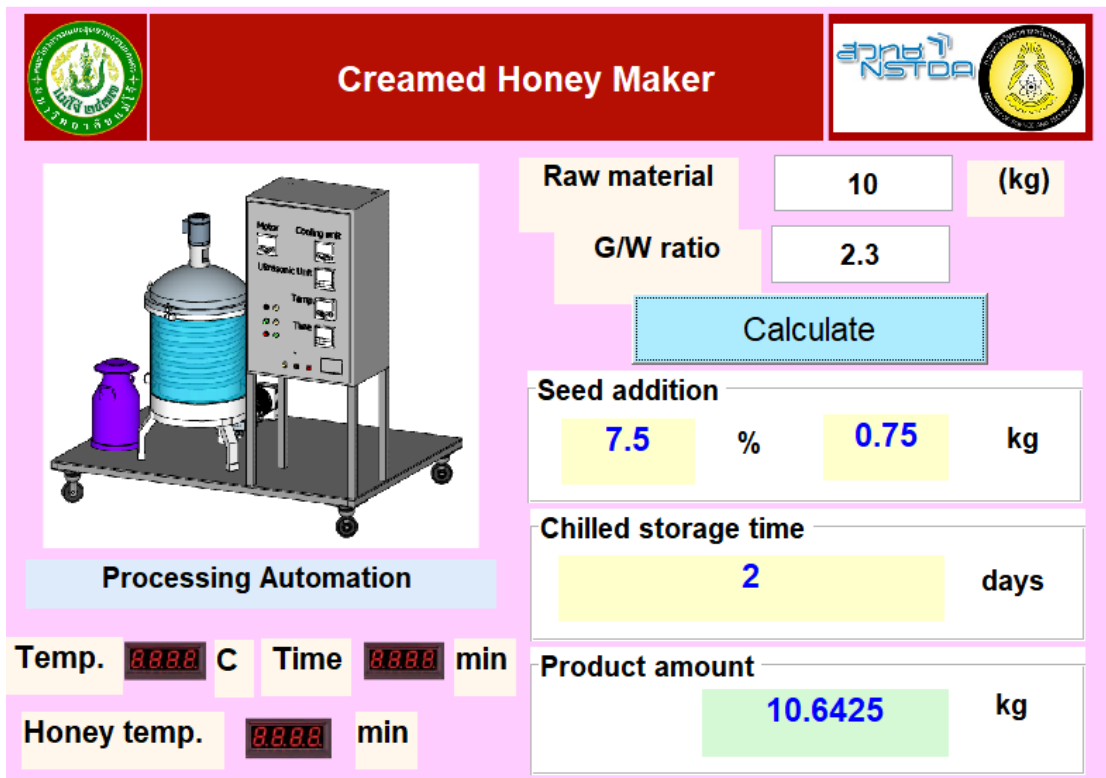

Figure 71 Screen example of a MATLAB program to design a creamed honey process

The GUI will calculate the suitable seed honey addition and the amount of final product following Avrami model under specific assumption. Automation control system included the temperature and time of the process following the ultrasonic frequency and power consumption. There were two input parameters including the raw material or liquid honey amount and the glucose per water ratio (G/W ratio). The amount of seed addition, storage time and the product amount were calculated and display before the machine start. Screen display will show the honey temperature during process and the suitable chilling time for final product (Figure 71). The processing and packing yield will calculate and explain in next part and use the data for estimating the cost of machine.

#### 4.4.2 Economic Analysis

Throughout the designing of the creamed honey maker, as discuss from the first, estimation of the cost of creamed honey maker was showed as in Table 28.

**Table 28** The assembly details and cost of creamed honey maker with ultrasonic

Detail	Description	QTY	Unit	Price per unit (THB)	Cost (THB)
1. Tank		1			
- Body	Stainless steel SUS316, acid resistant and with insulation	1	unit	40,000	40,000
- Bottling valve	Stainless valve, with flange 2", and stainless handle with support	1	pcs	500	500
2. Ultrasonic unit					
- Ultrasonic transducer	40 kHz 240W digital control, 200W heater	1	set	85,000	85,000
- Electronic temperature controller	7-segment LED display for an easy temperature reading. Temperature control is in the range of 5-80°C and measurement accuracy +/- 1.5°C. The running time of the basic controller is 1 to 96 hours after which time the unit switches off.	1	pcs	8,000	8,000
3. Cooling unit	power 275 Watts and 220 V. Chilled water tank is 100 L and cooling water in range 4-8C. Cooling rate is 6.5°C/min.	1	set	65,000	65,000

4. Agitating unit	100 - 1,500 rpm					
- motor power	0.18kW power, 230Volt, 50-300 rpm output, all parts including the motor channel, mount are made of Food Grade Materials	1	unit	15,000	15,000	
- Stainless agitator	Stainless steel mixer length 30 inch	1	pcs	5,000	5,000	
- Control box	Automatic monitor and adjust rpm of agitator, 100-1,500 rpm	1	pcs	4,500	4,500	
5. Accessories						
- Acrylic glass lid	3-5 mm Acrylic glass, the lid is hinged at one side so simply lift the lid, to add more honey, seed honey or just to look in. The other side of the lid, slips over the motor channel mount and is easily and quickly removed for full access.	1	pcs	5,000	5,000	
- Stand of motor on top	Stainless steel	1	pcs	3,000	3,000	
- Honey storage tank	200 L, made of stainless, acid-resistant steel with a thickness of 1 mm, closed with a lid and additionally with a stainless steel band bolted with two screws	2	tank	10,000	20,000	
<b>Total cost</b>					<b>251,000</b>	
<b>Cost of operation 70% of total</b>					<b>175,000</b>	
<b>Sale price of creamed honey maker</b>					<b>426,700</b>	
					<b>450,000</b>	

The details of estimated cost of creamed honey maker with ultrasonic and the assembly details were shown in Table 27, following the concept design. Sale

price of creamed honey maker is 426,700 THB, and finally sale in price is 450,000 THB/unit.

The production capacity of creamed honey maker was showed in Table 29, it showed that the machine can produce the creamed honey product is 105 – 112 L/cycle (raw material of liquid honey is 100 L). The creamed honey production capacity will calculate from the production yield and packing yield.

**Table 29** Production capacity of creamed honey maker

Details	Creamed sunflower honey	Creamed longan honey	Creamed wild honey
Initial liquid honey (L)		100	
Seed addition (%w/w)	SU (7.50)	LG (15.0)	WD (15.0)
Seed addition (L)	7.50	15.0	15.0
Balance (L)	107.50	115.0	115.0
Production yield (%)		99.00	
Product balance (L)	106.42	113.85	113.85
Packing yield (%)		99.00	
Product balance (L)	105.36	112.71	112.71
Approximate product volume (L)	105	112	112
Average density of creamed honey (kg/L)		1.36	
Approximate product weight (kg)	142	152	152
1. Net weight in 300 g (pack)	470	500	500
2. Net weight in 500 g (pack)	285	305	305
3. Net weight in 1 kg (pack)	142	152	152

Total cost of creamed honey production evaluated from summary of variable cost and fixed cost. In profit planning, there are techniques to be used for analysis. Analysis technique of the relation between Cost – Volume – Profit (CVP) or CVP analysis. In another term is called in Break – Even analysis. This technique will benefit with business for planning because it will analyze that the time for obtain the profit. In addition, if the total cost increased or the sales volume decreased, the

business will profit or loss. In accounting, the break-even point formula is determined by dividing the total fixed costs associated with production by the revenue per individual unit minus the variable costs per unit. In this case, fixed costs refer to those which do not change depending upon the number of units sold. Put differently, the break-even point is the production level at which total revenues for a product equal total expense.

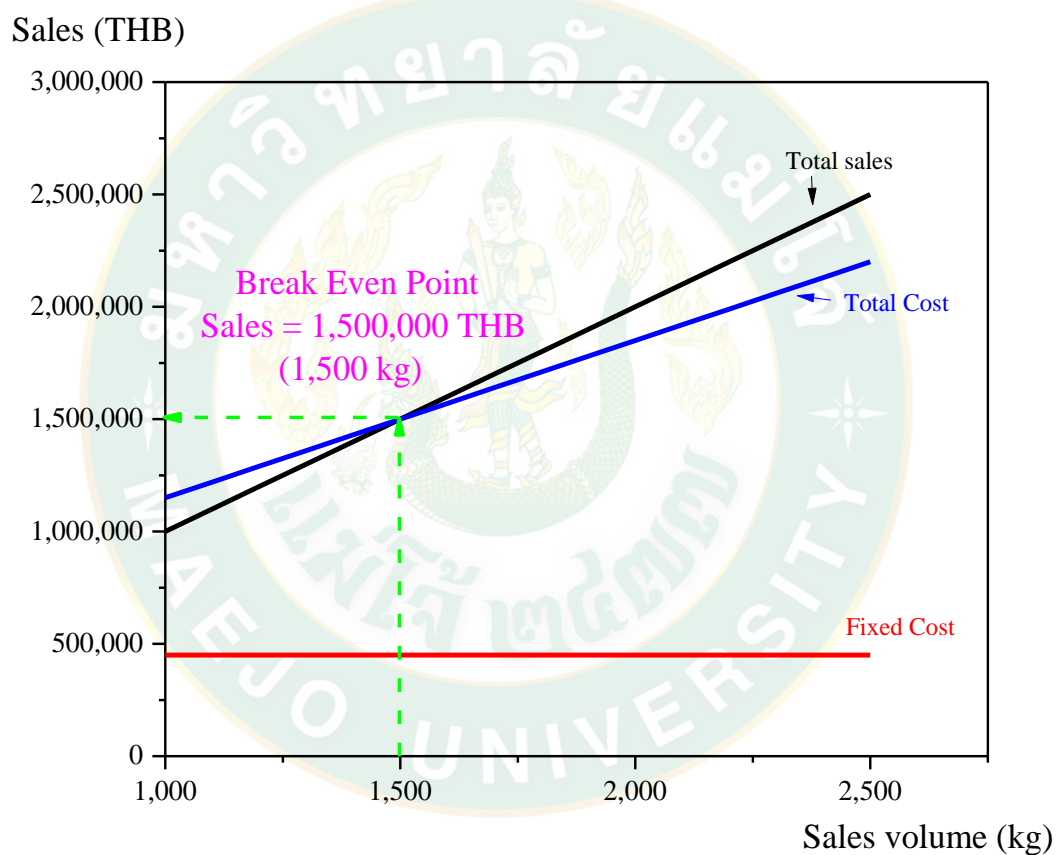

Figure 72 Break – Even Chart

Figure 72 showed break-even point of creamed honey maker in price of 450,000 THB. Variable cost were the various expenses arising from production or the costs that change with quantity or production activities. Moreover, raw material (liquid honey, seed honey and package), labor and support cost were including in variable cost, the estimated variable cost is 700 THB/kg. Fixed cost is the cost of

creamed honey maker. Estimated sales price is 1,000 THB/kg. Therefore, break-even point obtained from total cost line crosses the total sales. This result showed that break-even point presented in sales volume equal 1,500 kg and total sales at 1,500,000 THB. If we sales more than 1,500 kg, the business will get a profit, as shown in Table 30.

**Table 30** The economic analysis of creamed honey maker and payback period

Sales price (THB)	Sales volume (kg)	Total sales (THB)	Variable cost (THB)	Fixed cost (THB)	Total cost (THB)	Profit / Loss (THB)
1,000	1,000	1,000,000	700,000	450,000	1,150,000	-150,000
1,000	1,100	1,100,000	770,000	450,000	1,220,000	-120,000
1,000	1,200	1,200,000	840,000	450,000	1,290,000	-90,000
1,000	1,300	1,300,000	910,000	450,000	1,360,000	-60,000
1,000	1,400	1,400,000	980,000	450,000	1,430,000	-30,000
1,000	1,500	1,500,000	1,050,000	450,000	1,500,000	-
1,000	1,600	1,600,000	1,120,000	450,000	1,570,000	30,000
1,000	1,700	1,700,000	1,190,000	450,000	1,640,000	60,000
1,000	1,800	1,800,000	1,260,000	450,000	1,710,000	90,000
1,000	1,900	1,900,000	1,330,000	450,000	1,780,000	120,000
1,000	2,000	2,000,000	1,400,000	450,000	1,850,000	150,000
1,000	2,100	2,100,000	1,470,000	450,000	1,920,000	180,000
1,000	2,200	2,200,000	1,540,000	450,000	1,990,000	210,000
1,000	2,300	2,300,000	1,610,000	450,000	2,060,000	240,000
1,000	2,400	2,400,000	1,680,000	450,000	2,130,000	270,000
1,000	2,500	2,500,000	1,750,000	450,000	2,200,000	300,000



## CHAPTER 5

### CONCLUSION

#### 5.1 General conclusion

The result found that Thai creamed honey development by control of crystallization process with ultrasonic treatment can enhance the process efficiency around 40% when compared with Dyce's method.

##### 5.1.1 Effect of glucose and moisture content to the honey crystallization

The moisture reduction by vacuum far-infrared dryer at temperature 55°C, 5 kPa for 10 mins and glucose addition with 2.0%w/w is the method for increasing the G/W ratio in longan honey but glucose addition is the suitable method for raw material preparation of creamed honey production from the reason of without effecting with honey properties. The proper properties of liquid honey will be further producing in a fine texture of creamed honey product in next.

##### 5.1.2 The suitable process to produce creamed honey product

Thai creamed honey process by control of crystallization with ultrasonic treatment is starting from honey is heated with ultrasonic treatment at 40 kHz, at temperature of 55°C for 30 mins, and then the liquid honey is rapid cooled down in the rate of 6.5°C/min for taking the honey temperature reduce to below 20°C in the least time. The amount of seed addition is approximately in the range of 7.50 – 15.0%(w/w), depends on the G/W ratio, and control the temperature no warmer than 20°C. Rapid agitating at 1,000-1,300 rpm liked stir gently until the seed honey has been fully incorporated into the liquid honey. Ultrasonic at 40 kHz and intensity at 0.15 Watt/m<sup>2</sup> in chilled water was treated with the creamed honey product before keeping in chilled temperature. The storage time for obtain a firm texture is 2, 2 and 6 days in creamed sunflower, longan and wild honey, respectively, and further place at 18 – 22°C for 1 day for easy to spread or a soft texture.

The application of ultrasonic to control crystallization process appeared for improving the creamed honey both process and product. Developed method presented in 40% of process efficiency from the processing time when comparing with Dyce's method. Finally, all creamed honey product got a finely smooth texture and presented spreadability without a coarse grain by the hardness value in range 12-15 N as target value.

### **5.1.3 The suitable storage condition and shelf-life of creamed honey product**

The stability of product is the product shelf-life guarantee in creamy product. Almost creamed honey can keep in low temperature or in range 18 – 22°C without any variation of stability for >6 months, while creamed honey should not be stored at room temperature or at least 1 week to prevent the creamed honey from returning to the liquid form.

### **5.1.4 The crystallization model for creamed honey**

The Avrami equation was found to be a good model for describing the crystallization behavior from the intensity of absorbance values with sunflower and longan honey when induced with glucose addition and crystallization process with ultrasonic treatment in Thai creamed honey. The Avrami model of creamed honey will use to control the operation time under assumption of control crystallization with ultrasonic treatment. Creamed honey maker GUI was created from the developed process and used for automation control system of creamed honey process.

### **5.1.5 Food engineering innovation concept design**

The creamed honey maker prototype model was presented and desired following the developed process and hygienic concept design. The cost of creamed honey maker was estimated at 450,000 THB. The economic analysis was analyzed following Break-even analysis and break-even point will presented in sales volume of

1,500 kg or total sales at 1,500,000 THB. The profit attributed at the sales volume got higher than 1,500 kg of creamed honey product.

## 5.2 Recommendation

5.2.1 For further apply the Avrami equation with another honey type or any conditions, the relationship between the rate constant ( $k$ ), Avrami index ( $n$ ) and parameters of honey properties such as moisture content, initial concentration of sugar in honey, water activity; should be further considered.

5.2.2 The variation of ultrasonic intensity and temperature by apply with Avrami model should be further studied.

5.2.3 The process of Thai creamed honey product was suitable with sunflower, longan and wild honey which contained glucose per water ratio as reported. If the type and property of honey changed, the optimal process should be further study for obtaining the best texture and quality.

## 5.3 Novelty of this research

5.3.1 Thai creamed honey development by control of crystallization process with ultrasonic treatment was found to be new method for produce Thai creamed honey product with a smooth texture and reduce the processing time.

5.3.2 Monitoring of honey crystallization kinetic from the absorbance measurement at 660 nm was found to be a new finding.

5.3.3 The Avrami equation was the suitable model for explain the crystallization behavior of creamed honey.

5.3.4 The application of ultrasonic treatment appears to offer significant benefit with crystallization process in creamed honey production including narrowing of the metastable zone width (MZW), processing time reduction and improving product properties including handling and appearance.

## REFERENCES

- Ajlouni, S. & Sujirapinyokul, P. 2010. Hydroxymethylfurfuraldehyde and amylase contents in Australian honey. **Food Chemistry**, 119(3), 1000-1005.
- Alvarez-Suarez, J., Tulipani, S., Romandini, S., Bertoli, E. & Battino, M. 2010. **Contribution of honey in nutrition and human health: A review.**, 3, 15-23.
- Association of Official Analytical Chemists (AOAC). 2000. Sugars and sugar products: separation of sugars in honey. In Official Methods of Analysis of AOAC (17<sup>th</sup> ed). Gaithersburg: USA.
- Assil, H. I., Sterling, R. & Sporns, P. 1991. Crystal control in processed liquid honey. **Journal of Food Science**, 56(4), 1034-1034.
- Avrami, M. 1939. Kinetic of phase change I. General theory. **The Journal of Chemical Physics**, 7, 1103-1112.
- Avrami, M. 1940. Kinetic of phase change I. **The Journal of Chemical Physics**, 8, 212-217.
- Basmaci, I. 2010. **Effect of ultrasound and high hydrostatic pressure (HHP) on liquefaction and quality parameters of selected honey varieties.** Master Thesis. Middle East Technical University.
- Bhandari, B. & Bareyre, I. 2003. Estimation of crystalline phase present in the glucose crystal-solution mixture by water activity measurement. **LWT - Food Science and Technology**, 36(7), 729-733.
- Bhandari, B., D'Arcy, B. & Kelly, C. 1999. Rheology and crystallization kinetics of honey: Present status. **International Journal of Food Properties**, 2(3), 217-226.
- Bogdanov, S. 2008. Storage, cristallisation and liquefaction of honey. **Bee Product Science**, 1-5.
- Bogdanov, S. 2009. Harmonised methods of the International Honey Commission. Retrieved from International Honey Commission (IHC) website: <http://www.ihc-platform.net/ihcmethods2009.pdf>.
- Bogdanov, S. 2011. **Honey Technology (Chapter 3).** [Online]. Available <https://www.researchgate.net/publication/304011769>. (9 January 2020).

- Bogdanov, S., Lullmann, C., Mossel, B., D'arcy, B., Russmann, H., Vorwohl, G., Oddo, L., Sabatini, A., Marcazzan, G. & Piro, R. 1999. Honey quality, methods of analysis and international regulatory standards: review of the work of the International Honey Commission. **Mitt. Lebensm. Hyg.**, 90, 108-125.
- Briones, V. & Aguilera, J. M. 2005. Image analysis of changes in surface color of chocolate. **Food Research International**, 38(1), 87-94.
- Bucekova, M., Juricova, V., Di Marco, G., Gismondi, A., Leonardi, D., Canini, A. & Majtan, J. 2018. Effect of thermal liquefying of crystallised honeys on their antibacterial activities. **Food Chemistry**, 269, 335-341.
- Chaikhram, P., Kemsawasd, V. & Apichartsrangkoon, A. 2016. Effects of conventional and ultrasound treatments on physicochemical properties and antioxidant capacity of floral honeys from Northern Thailand. **Food Bioscience**, 15, 19-26.
- Chaikhram, P. & Prangthip, P. 2015. Alteration of antioxidative properties of longan flower-honey after high pressure, ultra-sonic and thermal processing. **Food Bioscience**, 10, 1-7.
- Chataway, H. 1932. The determination of moisture in honey. **Canadian journal of research**, 6(5), 532-547.
- Chemat, F., Zill e, H. & Khan, M. K. 2011. Applications of ultrasound in food technology: Processing, preservation and extraction. **Ultrason Sonochem**, 18(4), 813-835.
- Conforti, P. A., Lupano, C. E., Malacalza, N. H., A'rias, V. & Castells, C. B. 2006. Crystallization of Honey at  $-20^{\circ}\text{C}$ . **International Journal of Food Properties**, 9(1), 99-107.
- Cordella, C., Antinelli, J.-F., Aurieres, C., Faucon, J.-P., Cabrol-Bass, D. & Sbirrazzuoli, N. 2002. Use of Differential Scanning Calorimetry (DSC) as a New Technique for Detection of Adulteration in Honeys. 1. Study of Adulteration Effect on Honey Thermal Behavior. **Journal of Agricultural and Food Chemistry**, 50(1), 203-208.
- Cordella, C., Faucon, J.-P., Cabrol-Bass, D. & Sbirrazzuoli, N. 2003. Application of DSC as a tool for honey floral species characterization and adulteration detection. **Journal of thermal analysis and calorimetry**, 71(1), 279-290.

- Costa, L. C. V., Kaspchak, E., Queiroz, M. B., Almeida, M. M. d., Quast, E. & Quast, L. B. 2015. Influence of temperature and homogenization on honey crystallization. **Brazilian Journal of Food Technology**, 18(2), 155-161.
- Crane, E. 1980. Honey Crystallization. **National Honey Board Food Technology, Product Research Program**.
- Crane, E. 1990. **Bees and beekeeping: science, practice and world resources**. UK: Heinemann Newnes.
- D'Arcy, B. 2007. **High-power ultrasound to control of honey crystallisation**. Rural Industries Research and Development Corporation No. 07/145, Australian Government. Australia.
- Da Silva, P. M., Gauche, C., Gonzaga, L. V., Costa, A. C. & Fett, R. 2016. Honey: Chemical composition, stability and authenticity. **Food Chem**, 196, 309-323.
- Deora, N. S., Misra, N. N., Deswal, A., Mishra, H. N., Cullen, P. J. & Tiwari, B. K. 2013. Ultrasound for Improved Crystallisation in Food Processing. **Food Engineering Reviews**, 5(1), 36-44.
- Dettori, A., Tappi, S., Piana, L., Dalla Rosa, M. & Rocculi, P. 2018. Kinetic of induced honey crystallization and related evolution of structural and physical properties. **LWT**, 95, 333-338.
- Doner, L. W. 1977. The sugars of honey—a review. **Journal of the Science of Food and Agriculture**, 28(5), 443-456.
- Dyce, E. J. 1931a. Crystallization of honey. **Journal of Economic Entomology**, 24(3), 597-602.
- Dyce, E. J. 1931b. **Fermentation and crystallization of honey**. Cornell University, Agricultural Experiment Station; Ithaca, New York.
- Dyce, E. J. 1975. **Producing finely granulated or creamed honey**. In E. Crane (Ed.). Honey: A comprehensive survey.
- Elhamid, A. M. A. & Abou-Shaara, H. F. 2016. Producing clover and cotton creamed honey under cooling conditions and potential use as feeding to honey bee colonies. **Journal of Apiculture**, 31(1), 59-64.
- Faleiros, A., Rabelo, T. N., Thim, G. & Oliveira, M. 2000. Kinetics of Phase Change. **Materials Research**, 3, 51-60.

- Fauzi, N. A., Farid, M. M. & Silva, F. V. 2014. High-pressure processing of manuka honey: improvement of antioxidant activity, preservation of colour and flow behaviour. **Food and bioprocess technology**, 7(8), 2299-2307.
- Gielen, B., Jordens, J., Thomassen, L., Braeken, L. & Van Gerven, T. 2017. Agglomeration Control during Ultrasonic Crystallization of an Active Pharmaceutical Ingredient. **Crystals**, 7(2), 40.
- Gracin, S., Uusi-Penttilä, M. & Rasmuson, Å. C. 2005. Influence of Ultrasound on the Nucleation of Polymorphs of p-Aminobenzoic Acid. **Crystal Growth & Design**, 5(5), 1787-1794.
- Hebbar, H. U., Nandini, K. E., Lakshmi, M. C. & Subramanian, R. 2003. Microwave and infrared heat processing of honey and its quality. **Food Science and Technology Research**, 9(1), 49-53.
- Helvey, T. C. 1954. Study on some Physical Properties of Honey. **Journal of Food Science**, 19(1-6), 282-292.
- Horwitz, W., Chichilo, P. & Reynolds, H. 1970. **Official methods of analysis of the Association of Official Analytical Chemists**. Official methods of analysis of the Association of Official Analytical Chemists.
- Intipunya., P. & Metanee., N. 2012. Production of sugar crystal of sunflower honey. **In The 3rd CMU Graduate Research Conference**, 23 November, 2012, Chiang Mai University, Chiang Mai.
- Janghu, S., Bera, M. B., Nanda, V. & Rawson, A. 2017. Study on Power Ultrasound Optimization and Its Comparison with Conventional Thermal Processing for Treatment of Raw Honey. **Food Technol Biotechnol**, 55(4), 570-579.
- JOINT FAO/WHO FOOD STANDARD PROGRAMME CODEX ALIMENTARIUS COMMISSION Twenty-fourth Session Geneva, 2-7 July 2001, ALINORM 01/25 C.F.R. 2001.
- Kabbani, D., Sepulcre, F. & Wedekind, J. 2011. Ultrasound-assisted liquefaction of rosemary honey: Influence on rheology and crystal content. **Journal of Food Engineering**, 107(2), 173-178.
- Kabbani D., Wedekind J., Gaston E. & Sepulcre F. 2011. High-power ultrasound-

- assisted pasteurization of honey. In **11<sup>th</sup> International Congress on Engineering and Food**, Athens, Greece.
- Kaloyereas, S. A. 1955. Preliminary report on the effect of ultrasonic waves on the crystallization of honey. **Science**, 121(3140), 339-340.
- Kędzierska-Matysek, M., Florek, M., Wolanciuk, A. & Skątecki, P. 2016. Effect of freezing and room temperatures storage for 18 months on quality of raw rapeseed honey (*Brassica napus*). **Journal of Food Science and Technology**, 53(8), 3349-3355.
- Kim, H. N. & Suslick, K. S. 2018. The effects of ultrasound on crystals: Sonocrystallization and sonofragmentation. **Crystals**, 8(7), 280.
- Korkmaz, S. D. & KÜPLÜLÜ, Ö. 2017. Effects of storage temperature on HMF and diastase activity of strained honeys. **Ankara Üniversitesi Veteriner Fakültesi Dergisi**, 64(4), 281-287.
- Kunjet, S., Tedsree, N., Pumdara, T. & Sutthiphon, S. 2017. Effects of drying method on stable and quality of stingless bee honey. **KHON KAEN AGR. Journal**, 45(1), 25-30.
- Laos, K., Kirs, E., Pall, R. & Martverk, K. 2011. The crystallization behaviour of Estonian honeys. **Agron. Res.**, 9, 427-432.
- Liebl, D. E. 1977. **Method of preserving honey**: Google Patents.
- Lupano, C. E. 1997. DSC study of honey granulation stored at various temperatures. **Food Research International**, 30(9), 683-688.
- Manikis, I. & Thrasivoulou, A. 2001. The relation of physicochemical characteristics of honey and the crystallization sensitive parameters. **Apiacta**, 36(3), 106-112.
- McCabe, W.L., Smith, J.C. & Harriott, P. 2005. **Unit Operations of Chemical Engineering** (7<sup>th</sup> Edition). McGraw-Hill International Editions, 1130 pp.
- Mora-Escobedo, R., Moguel-Ordóñez, Y., Jaramillo-Flores, M. E. & Gutiérrez-López, G. F. 2006. The Composition, Rheological and Thermal Properties of Tajonal (*Viguiera Dentata*) Mexican Honey. **International Journal of Food Properties**, 9(2), 299-316.
- Mortaş, M. 2013. Application of ultrasound technology to honey. **Mellifera**, 13(25).



- Mossel, B., Bhandari, B., D'Arcy, B. & Caffin, N. 2000. Use of an Arrhenius Model to Predict Rheological Behaviour in some Australian Honey. **LWT - Food Science and Technology**, 33(8), 545-552.
- Myerson, A. 2002. **Handbook of industrial crystallization**. Butterworth-Heinemann.
- Nunta, R. & Intipunya, P. 2013. Melting of crystallized sunflower honey by high power ultrasonic method. **Food and Applied Bioscience Journal**, 1(1), 24-33.
- Nurul Zaizuliana, R., Anis Mastura, A., Abd Jamil, Z., Norshazila, S. & Zarinah, Z. 2017. Effect of storage conditions on the crystallisation behaviour of selected Malaysian honeys. **International Food Research Journal**, 24, S475-S480.
- Önür, İ., Misra, N. N., Barba, F. J., Putnik, P., Lorenzo, J. M., Gökmen, V. & Alpas, H. 2018. Effects of ultrasound and high pressure on physicochemical properties and HMF formation in Turkish honey types. **Journal of Food Engineering**, 219, 129-136.
- Pathare, P., Opara, U. & Al-Said, F. 2013. Colour Measurement and Analysis in Fresh and Processed Foods: A Review. **Food and Bioprocess Technology**, 6, 36-60.
- Phawatwiangnak, K. & Intipunya, P. 2013. Melting of crystallized sunflower honey by high power ultrasonic method. **Food and Applied Bioscience Journal**, 1(1), 24-33.
- Quintero-Lira, A., Ángeles Santos, A., Aguirre-Álvarez, G., Reyes-Munguía, A., Almaraz-Buendía, I. & Campos-Montiel, R. G. 2016. Effects of liquefying crystallized honey by ultrasound on crystal size, 5-hydroxymethylfurfural, colour, phenolic compounds and antioxidant activity. **European Food Research and Technology**, 243(4), 619-626.
- Rahima, D. K. 2014. **Ultrasound-assisted liquefaction of honey**. PhD Thesis, Universitat Politècnica de Catalunya.
- Rahman, M. & Ahmed, J. 2012. **Food Process Design: Overview in Handbook of Food Process Design**, First edition. Edited by Jasim Ahmed, M. Shafiur Rahman. Blackwell Publishing Ltd. Published 2011 by Blackwell Publishing Ltd, pp. 18-23.
- Richardson, J. & Coulson, J. 2002. **Chemical Engineering: Particle Technology and Seraration Processes**. Elsevier Engineering Information, Incorporated.
- Ruecroft, G., Hipkiss, D., Ly, T., Maxted, N. & Cains, P. W. 2005. Sonocrystallization: the

- use of ultrasound for improved industrial crystallization. **Organic Process Research & Development**, 9(6), 923-932.
- Sandu, C. 1986. Infrared radiative drying in food engineering: a process analysis. **Biotechnology progress**, 2(3), 109-119.
- Saravacos, G. & Kostaropoulos, A. E. 2016. Design of Food Processes and Food Processing Plants. In **Handbook of Food Processing Equipment** (pp. 1-50): Springer.
- Saxena, S., Panicker, L. & Gautam, S. 2014. Rheology of Indian Honey: Effect of Temperature and Gamma Radiation. **International Journal of Food Science**, 1-6.
- Shinn, J. M. & Wang, S. L. 1990. Textural Analysis of Crystallized Honey Using Response Surface Methodology. **Canadian Institute of Food Science and Technology Journal**, 23(4-5), 178-182.
- Srinual, K. 2007. **Factors affecting crystallization and physicochemical property changes of Thai honeys**. Master Thesis, Food Science and Technology, Chiang Mai University, Chiang Mai.
- Srinual, K. & Intipunya, P. 2009. Effects of crystallization and processing on sensory and physicochemical qualities of Thai sunflower honey. **Asian Journal of Food and Agro-Industry**, 2(4), 749-754.
- Stasiak, D. M. & Dolatowski, Z. J. 2007. Effect of sonication on the crystallization of honeys. **Polish Journal of Food and Nutrition Sciences**, 57(3 [A]), 133-136.
- Subba Rao, A. 1990. **Official methods of analysis of the association of analytical chemists (Chapter 44)** (Vol. 1, pp. 684). Arlington, Virginia USA: AOAC, Washington, DC.
- Subramanian, R., Umesh Hebbar, H. & Rastogi, N. K. 2007. Processing of Honey: A Review. **International Journal of Food Properties**, 10(1), 127-143.
- Sumit Kunjet, Nisachon Tedsree, pumdara, T. & Sutthiphon, a. S. 2017. Effects of drying method on stability and quality of stingless bee honey. **Khon Kaen Agr. Journal**, 45(1), 1355-1359.
- Thirawat, M. 2012. **A study of nucleation by attrition in agitated draft-tube baffle crystallizers**. Doctor of Philosophy Thesis, Chemical Engineering. Suranaree

University of Technology.

- Thrasylvoulou, A., Manikis, J. & Tselios, D. 1994. Liquefying crystallized honey with ultrasonic waves. **Apidologie**, 25(3), 297-302.
- TM Associates. 2018. **Questions and answers about Ultrasonic Cleaning**. [Online]. Available <http://www.t Masc.com/qa%20process.htm> (22 September 2020).
- Tomaszewska-Gras, J., Bakier, S., Goderska, K. & Mansfeld, K. 2015. Differential scanning calorimetry for determining the thermodynamic properties of selected honeys. **Journal of Apicultural Science**, 59(1), 109-118.
- Tosi, E. A., Ré, E., Lucero, H. & Bulacio, L. 2004. Effect of honey high-temperature short-time heating on parameters related to quality, crystallisation phenomena and fungal inhibition. **LWT - Food Science and Technology**, 37(6), 669-678.
- Van Den Berg, A. 1998. **The Production of "Good" Creamed Honey**. The University of Queensland, St Lucia.
- Venir, E., Spaziani, M. & Maltini, E. 2010. Crystallization in "Tarassaco" Italian honey studied by DSC. **Food Chemistry**, 122(2), 410-415.
- Wanjai, C., Sringarm, K., Santasup, C. & Pak-uthai, S. 2012. Physicochemical and microbiological properties of longan, bitter bush, sunflower and litchi honeys produced by *Apis mellifera* in Northern Thailand. **Journal of Apicultural Research**, 51, 36-44.
- White, J. & Doner, L. W. 1980. Honey composition and properties. **Beekeeping in the United States Agriculture Handbook**, 335, 82-91.
- White Jr, J. W. 1975. Physical characteristics of honey. **Honey: A Comprehensive Survey**. E. Crane, ed.
- Zamora, M. C. & Chirife, J. 2006. Determination of water activity change due to crystallization in honeys from Argentina. **Food Control**, 17(1), 59-64.
- Zhang, Z., Sun, D. W., Zhu, Z. & Cheng, L. 2015. Enhancement of crystallization processes by power ultrasound: current state-of-the-art and research advances. **Comprehensive Reviews in Food Science and Food Safety**, 14(4), 303-316.



APPENDIX



APPENDIX A  
MATLAB script

## Crystallization kinetic by MATLAB program

### Crystallization kinetic from Avrami equation by MATLAB program

```
%Crystallization kinetic fitting curve
%time CT, x=[0 1 3 7 9 11 14 16 18 21 23 25 27 34 40];
%control SU, y=[0.03368 0.03366 0.03345 0.03019 0.03558 0.06256 0.26575 0.52041 0.59187 0.74512 0.90269 1 0.97379 0.98222 0.97919];
%time, x=[0 1 3 7 9 11 14 16 18 21 23];
%1.0-SU, y=[0.03293 0.11061 0.13875 0.53254 0.73143 0.89707 0.96566 0.98395 0.97786 1 0.99886];
%1.5-SU, y=[0.033 0.19 0.226 0.659 0.769 0.855 0.947 0.967 0.98 1 0.999];
%2.0-SU, y=[0.033 0.249 0.38 0.867 0.892 0.948 0.977 1 0.985 0.98 0.979];
%2.5-SU, y=[0.032 0.3 0.359 0.823 0.865 0.9 0.937 0.966 0.978 1 0.999];

%time, x=[0 1 3 7 14 20 22 27 34 45];
%control LG, y=[0.03957 0.03957 0.04276 0.04291 0.04562 0.04714 0.05604 0.12665 0.24255];
%1.0-LG, y=[0.03691 0.13717 0.16591 0.22057 0.37986 0.59587 0.61551 0.81475 0.98289 1];
%1.5-LG, y=[0.03615 0.28538 0.2963 0.37195 0.56411 0.75417 0.7738 0.88496 0.97682 1];
%2.0-LG, y=[0.03475 0.28047 0.31372 0.44993 0.58696 0.79271 0.80873 0.91177 0.97204 1];
%2.5-LG, y=[0.03874 0.35292 0.37358 0.49616 0.60997 0.67188 0.69226 0.85838 0.94409 1];

clear
x=[0 1 3 7 9 11 14 16 18 21 23];
y=[0.033 0.249 0.38 0.867 0.892 0.948 0.977 1 0.985 0.98 0.979];
f1 = @(p,x) 1-(exp(-p(1)*(x.^p(2))));
pguess = [0.1,0.1];
disp('Avrami Equation')
mdl = NonLinearModel.fit(x,y,f1,pguess)
plot(x,y,'*')
hold on
y=1-(exp(-0.17652*(x.^1.1595)));
plot(x,y,'r')
xlabel('Time (day)'), ylabel('X(t),relative crystallized fraction')
title(['Crystallization kinetic of sunflower honey with 2.0%5'], 'FontSize', [11])
```

```
>> Untitled1
Avrami Equation

mdl =

Nonlinear regression model:
    y ~ 1 - (exp(- p1*(x^p2)))

Estimated Coefficients:

|           | Estimate | SE       | tStat  | pValue     |
|-----------|----------|----------|--------|------------|
| <b>p1</b> | 0.077605 | 0.021944 | 3.5366 | 0.0063484  |
| <b>p2</b> | 1.3411   | 0.13307  | 10.078 | 3.3551e-06 |



Number of observations: 11, Error degrees of freedom: 9
Root Mean Squared Error: 0.0455
R-Squared: 0.986, Adjusted R-Squared 0.985
F-statistic vs. zero model: 1.6e+03, p-value = 3.32e-12
```

```
>> Untitled1
Avrami Equation

mdl =

Nonlinear regression model:
    y ~ 1 - (exp(- p1*(x^p2)))

Estimated Coefficients:

|           | Estimate | SE       | tStat  | pValue     |
|-----------|----------|----------|--------|------------|
| <b>p1</b> | 0.17652  | 0.038349 | 4.603  | 0.001285   |
| <b>p2</b> | 1.1595   | 0.12308  | 9.4205 | 5.8679e-06 |



Number of observations: 11, Error degrees of freedom: 9
Root Mean Squared Error: 0.0473
R-Squared: 0.984, Adjusted R-Squared 0.982
F-statistic vs. zero model: 1.67e+03, p-value = 2.7e-12
```

## GUI program for monitor display of creamed honey maker

```

function varargout = Doctor_of_Food_Engineering(varargin)
% DOCTOR_OF_FOOD_ENGINEERING MATLAB code for Doctor_of_Food_Engineering.fig
gui_Singleton = 1;
gui_State = struct('gui_Name',       mfilename, ...
                  'gui_Singleton',  gui_Singleton, ...
                  'gui_OpeningFcn', @Doctor_of_Food_Engineering_OpeningFcn, ...
                  'gui_OutputFcn',  @Doctor_of_Food_Engineering_OutputFcn, ...
                  'gui_LayoutFcn',  [], ...
                  'gui_Callback',    []);

if nargin && ischar(varargin{1})
    gui_State.gui_Callback = str2func(varargin{1});
end

if nargout
    [varargout{1:nargout}] = gui_mainfcn(gui_State, varargin{:});
else
    gui_mainfcn(gui_State, varargin{:});
end
% --- Executes just before Doctor_of_Food_Engineering is made visible.
function Doctor_of_Food_Engineering_OpeningFcn(hObject, eventdata, handles, varargin)

handles.output = hObject;
im=imread('temp.jpg');
imshow(im);
axes(handles.axes1);

im1=imread('Logomju.png');
imshow(im1);
axes(handles.axes2);

im2=imread('nstda.png');
imshow(im2);
axes(handles.axes3);

im3=imread('prototype.png');
imshow(im3);
axes(handles.axes6);

im4=imread('temp.jpg');
imshow(im4);
axes(handles.axes7);

im5=imread('temp.jpg');
imshow(im5);
axes(handles.axes8);

guidata(hObject, handles);
%%%%%%%%%%%%%%%%%%%%%%%%%%%%%%%%%%%%%%%%%%%%%%%%%%%%%%%%%%%%%%%%%%%%%%%%
function pushbutton1_Callback(hObject, eventdata, handles)

```

```

W1=str2num(get(handles.edit6,'String'));
GW=str2num(get(handles.edit7,'String'));
W2=0.075*W1;
set(handles.text14,'String',W2)
if (GW>2)
    S=7.5;
    set(handles.text13,'String',S)
elseif (GW<=2&GW>=1.7)
    S=15;
    set(handles.text13,'String',S)
elseif (GW<1.7)
    S=15;
    set(handles.text13,'String',S)
end
%%%%%%%%%%%%%%%%%%%%%%%%%%%%%%%%%%%%%%%%%%%%%%%%%%%%%%%%%%%%%%%%%%%%%%%%
if (GW>2)
    t=2;
    set(handles.text29,'String',t)
elseif (GW<=2&GW>=1.7)
    t=2;
    set(handles.text29,'String',t)
elseif (GW<1.7)
    t=6;
    set(handles.text29,'String',t)
end
Y=(W1+W2)*0.99;
set(handles.text15,'String',Y)
function varargout = Doctor_of_Food_Engineering_OutputFcn(hObject, eventdata, handles)
varargout{1} = handles.output;

function edit6_Callback(hObject, eventdata, handles)

function edit6_CreateFcn(hObject, eventdata, handles)

if ispc && isequal(get(hObject,'BackgroundColor'), get(0,'defaultUicontrolBackgroundColor'))
    set(hObject,'BackgroundColor','white');
end

function edit7_Callback(hObject, eventdata, handles)

function edit7_CreateFcn(hObject, eventdata, handles)

if ispc && isequal(get(hObject,'BackgroundColor'), get(0,'defaultUicontrolBackgroundColor'))
    set(hObject,'BackgroundColor','white');
end

function figure1_CreateFcn(hObject, eventdata, handles)

function text24_ButtonDownFcn(hObject, eventdata, handles)

```





APPENDIX B

Thermal phenomena by DSC

### Differential Scanning Calorimetry analysis

A Mettler-Toledo DSC 1 Module with the STARe software (Mettler-Toledo) was used to follow the thermal behaviour of honey samples. Indium and zinc standards were used to calibrate the differential scanning calorimeter, and the measuring range was extended to  $-65^{\circ}\text{C}$  by a cooling Intra Cooler system. A calorimetric heat flow was used to obtain quantitative and qualitative data concerning the net heat changes produced by carbohydrates during their heating. Samples of  $\sim 10$  mg of honey were placed in weighed aluminum DSC hermetic pans, and as a reference, an empty crucible was simultaneously measured. The experiments were conducted from  $-65$  to  $200^{\circ}\text{C}$  to obtain the complete thermal behaviour of pure honey and creamed honey from low temperature to high temperature. Various start temperatures and heating rates were applied to the samples following literature reports (Cordella et al., 2002; Cordella et al., 2003; Tomaszewska-Gras et al., 2015). After we evaluated the effect in the range of 2- $50^{\circ}\text{C}/\text{min}$ , we selected a heating rate of  $10^{\circ}\text{C}/\text{min}$ . The calorimetric response improved this heating rate without a decrease in accuracy, reduced the analysis time, and decreased the risk of sample degradation. Three DSC runs were performed to determine various glass transition temperatures ( $T_g$ ) and the melting behaviour of the samples at higher temperatures to calculate the enthalpy of crystal melting ( $\Delta H_m, \text{J} / \text{g}$ ) and enthalpy of sugar fusion ( $\Delta H_f, \text{J} / \text{g}$ ).

## Thermogram of honey and creamed honey

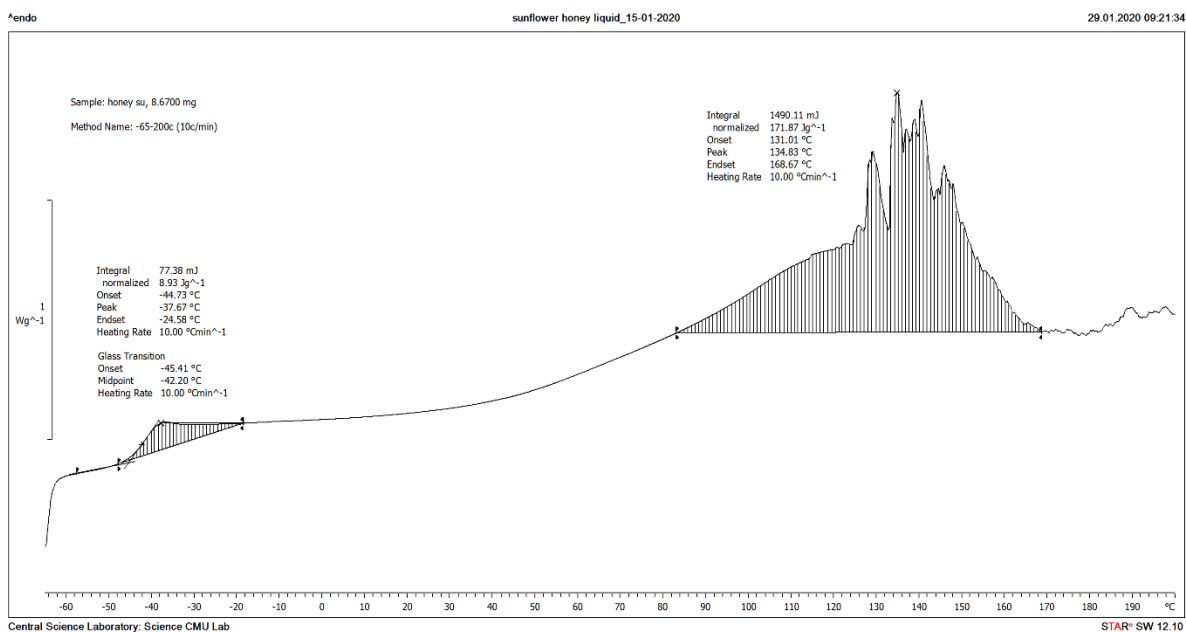

(A) Liquid sunflower honey

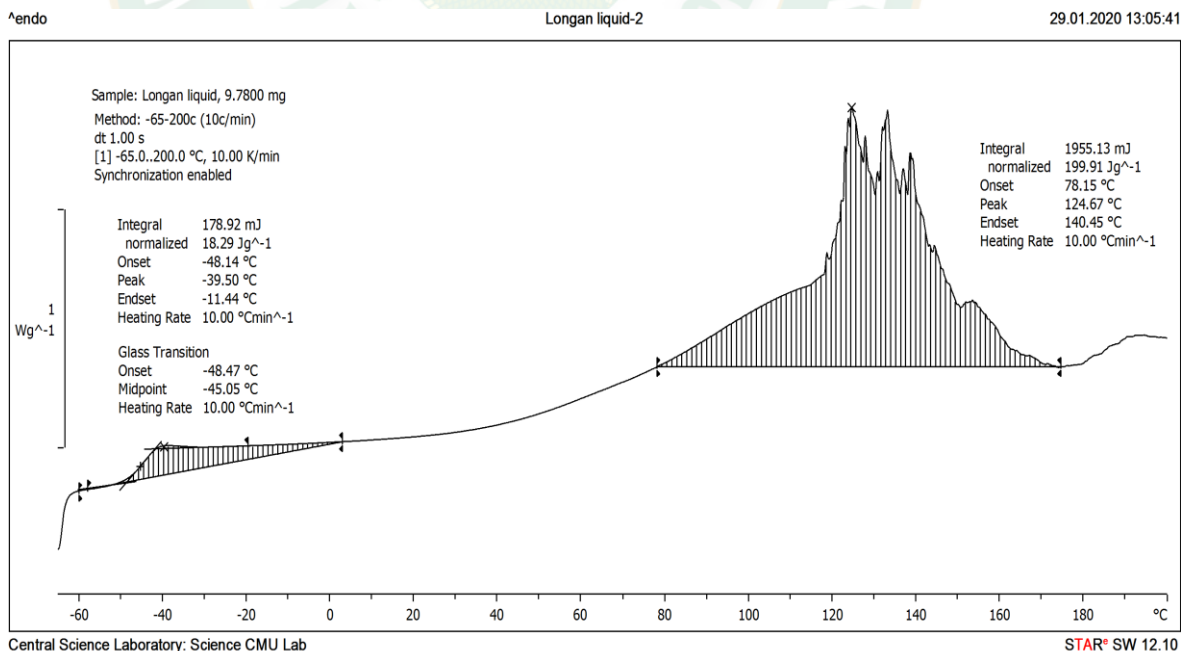

(B) Liquid longan honey

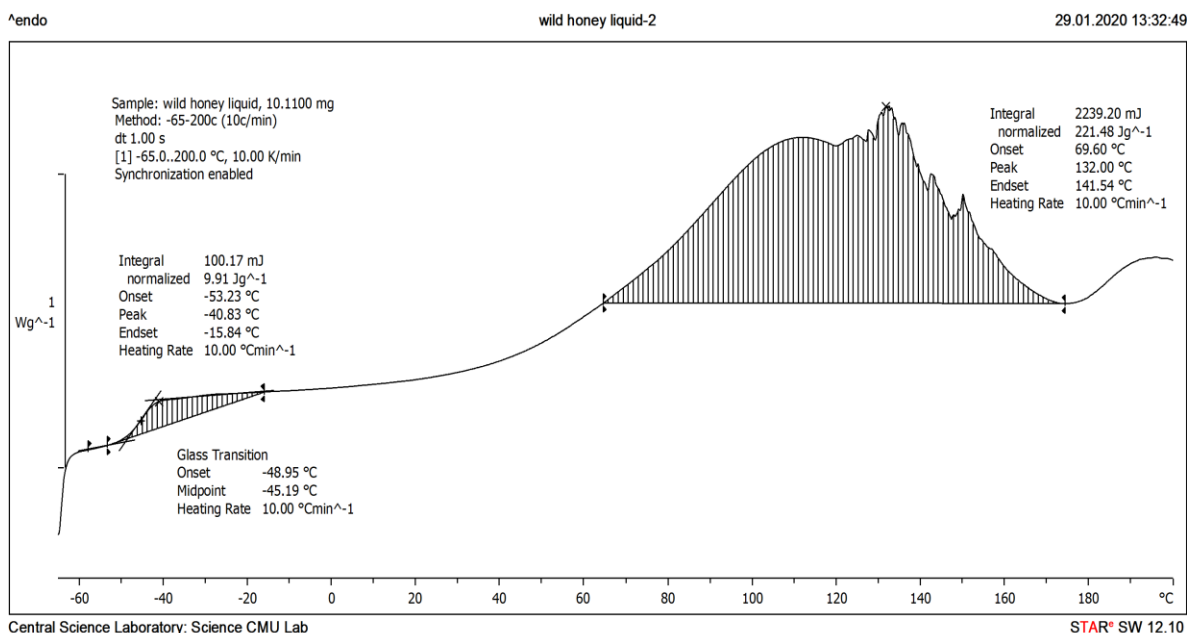

(C) Liquid wild honey

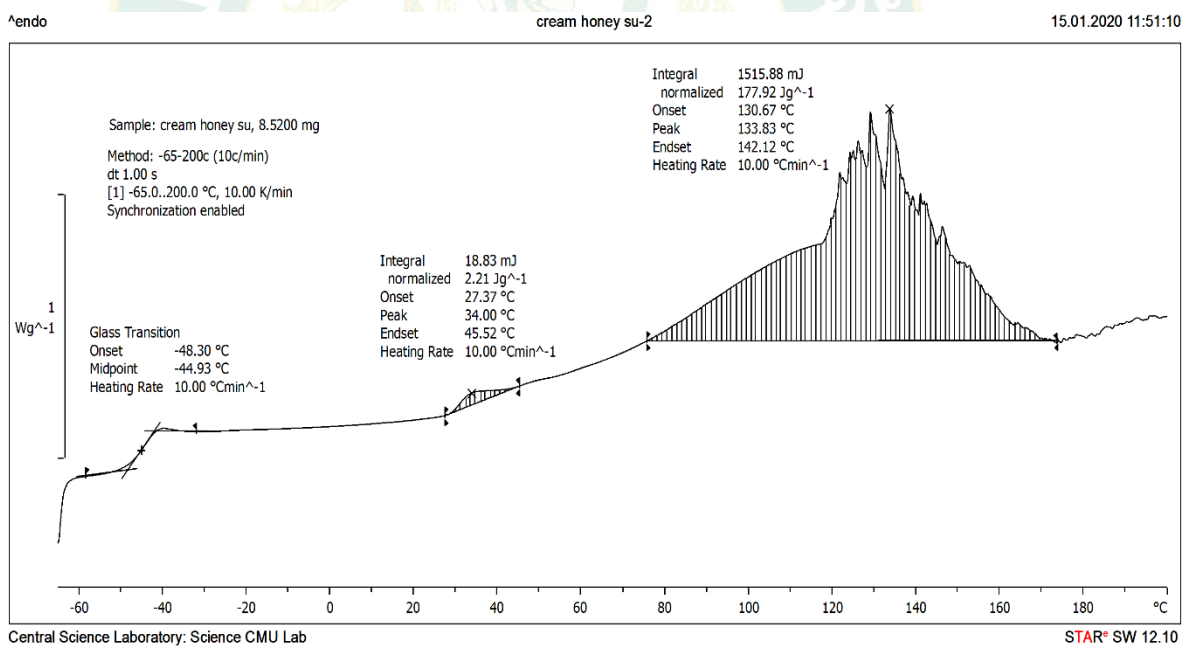

(D) Creamed sunflower honey

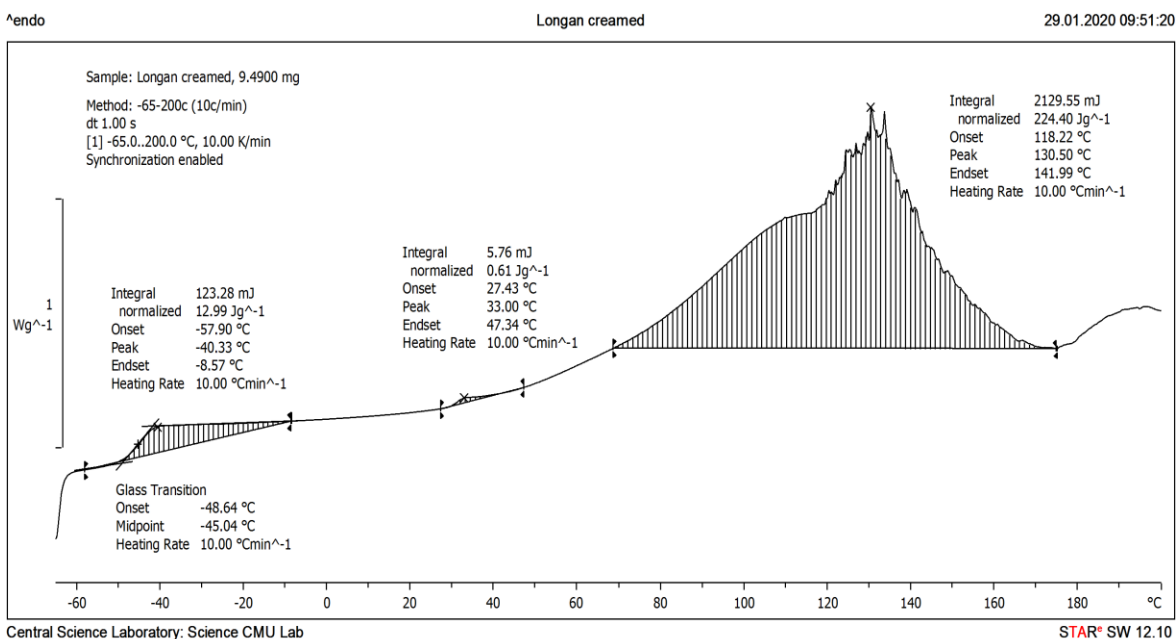

(E) Creamed longan honey

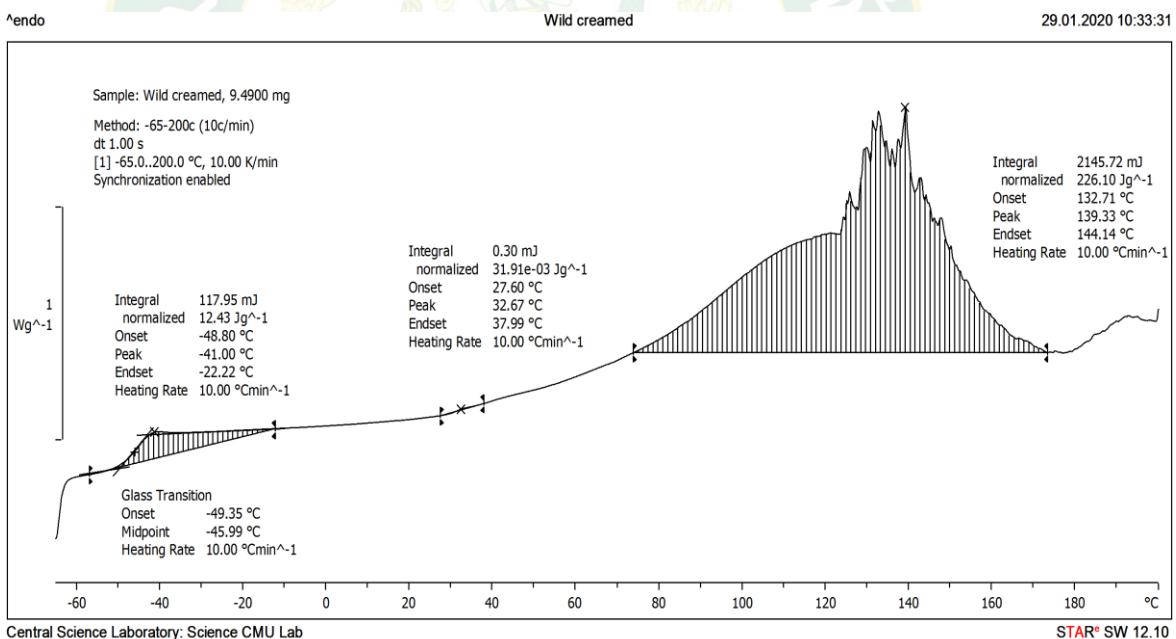

(F) Creamed wild honey



APPENDIX C  
Research Publication I



## Crystallisation behaviour of sunflower and longan honey with glucose addition by absorbance measurement

Suriwong, V., \*Jaturonglumert, S., Varith, J., Narkprasom, K. and Nitatwicht, C.

Graduate Program in Food Engineering, Faculty of Engineering and Agro-Industry,  
Maejo University, Chiang Mai 50290, Thailand

### Article history

Received: 11 February 2020

Received in revised form:

7 May 2020

Accepted:

4 June 2020

### Keywords

crystallisation model,  
glucose,  
longan honey,  
sunflower honey

### Abstract

The present work aimed to study the crystallisation behaviour of honey with glucose addition by using the absorbance measurement at 660 nm. The Avrami model was used to explain the crystallisation kinetic. The effect of glucose addition on the colour and microstructure of crystallised honey was also determined. Sunflower and longan honey were used in the present work. The biochemical compositions of honey samples were analysed before the addition of glucose powder at four concentrations (1.0, 1.5, 2.0, and 2.5% w/w) and stored at 10 - 15°C. The absorbance at 660 nm, colour, and microstructure were measured until full crystallisation. The results showed that different honey compositions exhibited different crystallisation behaviours, which could be monitored by the absorbance measurement at 660 nm as well. The addition of glucose powder could stimulate the crystallisation time, thus affecting the crystallisation rate. The Avrami equation was found to be a good model for describing the crystallisation behaviour from the intensity of absorbance values. The highest crystallisation rate was found at 2.0% (w/w) glucose addition at the rate constant ( $k$ ) of  $0.177 \pm 0.038$  and  $0.083 \pm 0.039$  in sunflower and longan honey, respectively. The Avrami index ( $n$ ) was relevant to the crystallisation rate, but not clearly related to crystal shape or size. The crystals of all glucose-added honey contained small crystals in bouquets. The yellow colour became lighter during storage period. Suitable glucose content and absorbance monitoring at 660 nm could be used to control the crystallisation of honey for obtaining creamed honey product with good texture.

© All Rights Reserved

### Introduction

Honey is a naturally sweet and viscous food produced by bees and some related insects. It consists of approximately 181 substances including fructose, glucose, water, maltose, and other constituents (Hagr *et al.*, 2017; Singh and Singh, 2018). Its physicochemical properties and flavour depend on the flower sources, geographical regions, and honeybee types. These factors affect the crystallisation behaviours as well. The most popular and abundant kind of honey in Northern Thailand is longan honey (Chaikham *et al.*, 2016), which has a strong fruity scent and unique taste with dark brown colour. Due to the honey's brown colour and strong aroma, it is almost impossible to further develop it into another food product, hence, almost all longan honey found in Thailand markets is pure liquid longan honey. To further increase its market value, longan honey should and could be developed into new food product. One such product which would likely be popular and interesting in Thailand is creamed honey.

Creamed honey product is produced from

honey with the crystallisation process controlled, and it is normally produced from honey that is ready to crystallise during storage. However, a coarse and gritty texture is often found due to the crystallised honey being subjected to an uncontrolled crystallisation process. By controlling the crystallisation process and proper raw material preparations, this can result in a value-added honey product. In Thailand, sunflower honey tends to crystallise during storage and might easily be produced into a creamed honey product. Therefore, we selected two honey types to be assessed in the present work, which is sunflower and longan honey, which consisted of different properties.

Dyce method is a method of producing creamed honey, and the process is as follows: 5 - 10% (w/w) of granulated honey is added and stored at 14°C until full crystallisation (Elhamid and Abou-Shaara, 2016). However, many researchers have found different textures when using different honey types. Therefore, the crystallisation behaviour and glucose effect are important parameters for the design of suitable creamed honey processing. Some reports (Conforti

\*Corresponding author.  
Email: [yaidragon@mju.ac.th](mailto:yaidragon@mju.ac.th)

et al., 2006; Costa et al., 2015; Jaturonglumlert et al., 2015; Elhamid and Abou-Shaara, 2016) have studied the influence of storage temperature and glucose content on crystallisation behaviour and colour of honey (Kędzierska-Matysek et al., 2016a; 2016b). However, no studies have correlated these with creamed honey texture. Moreover, there are few reports that have endeavoured to develop a quick spectrophotometric method to monitor the crystallisation process of creamed honey production from sunflower and longan honey. Several studies (Lupano, 1997; Venir et al., 2010; Laos et al., 2011; Dettori et al., 2018) have been published about the crystallisation kinetics of honey and sugar mixtures using differential scanning calorimetry (DSC), and tried to explain the kinetics of honey crystallisation with the mathematical model.

The Avrami equation was found to suitably describe the honey crystallisation kinetics from DSC measurement during induced crystallisation (Dettori et al., 2018), but has not applied the absorbance value at 660 nm. Conforti et al. (2006) and Lupano (1997) reported that turbidity measurement at 660 nm can be taken as an indicator of honey granulation. The increase in turbidity indicates the presence of more honey crystals. But there is a lack of study concerning honey crystallisation modelling, both for monitoring the crystallisation kinetic, and further application in the design of creamed honey process.

Therefore, the objective of the present work was to describe the crystallisation behaviour of honey with glucose addition by measuring the absorbance at 660 nm and Avrami model. The information obtained was applied to design a creamed honey process with the best texture. The effects of glucose addition on the colour and microstructure of crystallised honey were also determined.

## Materials and methods

### Raw materials and sample preparation

Sunflower and longan honey (fresh and non-crystallised honey) were purchased from Supha Bee Farm in Chiang Mai, Thailand. Samples were heated at 50°C to eliminate natural crystals and osmotolerant/osmophilic yeasts by using a water bath (Tosi et al., 2004). Heated honey samples were kept at room temperature before seeding addition. Glucose monohydrate powder (C<sub>6</sub>H<sub>12</sub>O<sub>6</sub>, Merck, Germany) was employed as seed (Elhamid and Abou-Shaara, 2016; Dettori et al., 2018). Four levels of glucose were added at 1.0, 1.5, 2.0, and 2.5% (w/w) of ~40 g of liquid honey. Glucose powder was added in both honey types, but none was added to the control sample. Samples

were manually stirred with a spatula at room temperature for about 10 min to thoroughly mix between the glucose powder and liquid honey (Dettori et al., 2018). Samples were then stored at a chilling temperature (10 - 15°C) to allow for crystallisation process. The temperature in the refrigerator was daily checked during the experiment. Creamed honey samples were periodically measured for absorbance at different sampling periods and visual observation was conducted to check the overall appearance. If there were crystals occurring throughout the honey sample, it was deemed as full crystallisation.

### Biochemical compositions of honey

The moisture content was determined following a refractive index method (Bogdanov, 2009) by measuring the refractive index of honey with a digital Abbe refractometer (KRUSS, Germany). Three samples from each trial were analysed for determination of moisture, and the average moisture content was reported. Sugar content (fructose, glucose, sucrose, and maltose) was determined by HPLC, following the method 977.20 (AOAC, 2000). Water activity was measured by using a water activity meter (AQUA Lab 3TE, USA). The measurements of each sample were duplicated, and the average water activity was calculated.

The colour was measured by using a spectrophotometer (HunterLab Miniscan XE plus, Germany) and reported in values of L\*, a\*, and b\*. Calibration of instrument was done with a black and white standard tile before each set of measurements. The L\* colour value presented the degree of brightness or whiteness of the sample, while a\* and b\* colour values indicated the degree of redness and yellowness, respectively. Three measurements were done in each sample. All parameters were used to calculate the hue angle (h°) and Whiteness Index (WI) (Briones and Aguilera, 2005; Costa et al., 2015) as in Eqs. 1, 2, and 3:

$$h^{\circ} = \arctan \operatorname{gent} \left( \frac{b^*}{a^*} \right) \quad \text{when } a^* > 0 \text{ and } b^* > 0 \quad (\text{Eq. 1})$$

$$h^{\circ} = \arctan \operatorname{gent} \left( \frac{b^*}{a^*} \right) + 180 \quad \text{when } a^* < 0 \quad (\text{Eq. 2})$$

$$WI = 100 - \left[ (100 - L^*)^2 + a^{*2} + b^{*2} \right]^{0.5} \quad (\text{Eq. 3})$$

### Microstructure analysis

Honey samples were microstructurally



observed at room temperature using a light microscopy (Olympus, model BX51TF, Japan) at a magnification of  $40\times$  (Lupano, 1997).

#### Turbidity of honey

Honey samples were poured into a cuvette of about 1 cm path-length. Some trials with many types of liquid honey were taken to scan for wavelength in a range between 200 - 700 nm which presented a smooth curve in a range between 600 - 700 nm. Therefore, the absorbance was measured at 660 nm at room temperature by a spectrophotometer (Model SPECTRO SC, USA) following trials and literature review by Lupano (1997), Conforti *et al.* (2006) and Costa *et al.* (2015).

#### Crystallisation kinetic of honey

Regarding different samples that reached different final absorbance values ( $A_{660}$ ), we considered  $X$  as 1, which is the maximum absorbance ( $A_{660max}$ ) to compare kinetics of the crystallisation process. Thus, we considered the increase of the relative crystallised fraction  $X(t)$  during storage as Eq. 4.

$$X(t) = \frac{A_{660}}{A_{660max}} \quad (\text{Eq. 3})$$

where, ( $A_{660}$ ) = the absorbance wavelength at 660 nm at any time, ( $A_{660max}$ ) = the absorbance wavelength at 660 nm at a maximum value of any treatment, and  $X(t)$  = the relative crystallised glucose fraction at the time  $t$ . The Avrami equation (Avrami, 1939) describes the proportion of crystals presented at time ( $t$ ) compared with glucose crystals in full crystallisation

time, as shown in Eq. 5 (Dettori *et al.*, 2018).

$$X(t) = 1 - \text{EXP}[-k(t^n)] \in [0,1] \quad (\text{Eq. 4})$$

where,  $k$  = rate constant of crystallisation process, and  $n$  = Avrami index, a parameter characteristic of nucleation and growth mechanisms of the crystals.

#### Statistical analysis

As an independent experiment, the results were expressed as mean  $\pm$  standard deviation (mean  $\pm$  S.D.) of triplicate testing ( $n = 3$ ). Statistical analysis was performed using analysis of variance (ANOVA), followed by Duncan's multiple range test (DMRT). Duncan's method was employed to analyse the significant difference in responses at  $p \leq 0.05$ . Statistical processing was carried out using SPSS 17. The coefficient of determination ( $R^2$ ) was also calculated to statistically evaluate the accuracy of the mathematical model to simulate crystallisation kinetics.

## Results and discussion

#### Characterisation and biochemical compositions of honey

Both sunflower and longan honey were clear liquid; in which crystals were not present before the addition of glucose. The biochemical compositions of sunflower and longan honey are shown in Table 1 with a corresponding glucose concentration of 39.01 and 33.31%, respectively. The water percentage of sunflower and longan honey were 18.37 and 15.70%, respectively. Thus, the resulting glucose/water (G/W) ratio ranged between 2.11 - 2.12. The fructose/glucose

Table 1. Biochemical compositions (g/100 g) of honey samples.

Honey property	Honey type	
	Sunflower honey	Longan honey
Moisture (% wet basis)	18.37 $\pm$ 0.09	15.70 $\pm$ 0.31
Total solids (% w/w)	80.06 $\pm$ 0.18	82.80 $\pm$ 0.17
Water activity ( $a_w$ )	0.616 $\pm$ 0.002	0.570 $\pm$ 0.004
Fructose	40.15 $\pm$ 0.57	41.56 $\pm$ 2.14
Glucose	39.01 $\pm$ 0.51	33.31 $\pm$ 1.03
Sucrose	0.39 $\pm$ 0.05	0.76 $\pm$ 0.03
Maltose	1.50 $\pm$ 0.04	0.57 $\pm$ 0.04
Lactose	<i>not detected</i>	<i>not detected</i>
(Fructose/Glucose) ratio	1.03	1.25
(Glucose/Water) ratio	2.12	2.11

Data are means  $\pm$  standard deviations of three replicates ( $n = 3$ ).

(F/G) ratio of sunflower honey was less than 1.14 (White, 1975), where rapid crystallisation was found; while F/G ratio of longan honey was 1.25, relatively close to optimised value of 1.33 and categorised as slow or non-granulating honey. Regarding the tendency of honey, crystallisation depends on its composition and moisture content. This is why the sunflower and longan honey were selected in the present work, they represent honey with rapid and non-crystallisation behaviours, respectively. The absorbance measurement during storage was studied in order to explain the crystallisation behaviour. Glucose powder was added to induce crystallisation (Lupano, 1997).

#### Turbidity of honey

More granulated honey resulted in greater turbidity values. An increase in the absorbance intensity at 660 nm was considered valid to determine the extension of honey granulation (Lupano, 1997). Liquid of sunflower and longan honey, which were stored at chilling temperature, were found to have an increasing turbidity interpreted from the absorbance at 660 nm. From different crystallisation behaviours (Figure 1A), it was shown that the absorbance at 660 nm of honey stored at 10 - 15°C without glucose addition (control sunflower and control longan) is a function of storage time. However, this has shown different characteristics, and the absorbance rapidly increased in sunflower honey until the absorbance value reached 3 (23 days). Moreover, the appearance was in light yellow colour and turbid. The absorbance of longan honey slowly increased and no crystals were found for more than 120 days due to it being slow or non-granulating honey. Therefore, the absorbance at 660 nm was correlated with the overall appearance of honey during storage in chilled temperature.

A correlation between the fructose/glucose (F/G) ratio and crystallisation behaviour was also obtained. Sunflower honey had a low F/G ratio (1.03) which was equal or less than 1.14, resulted in fast or rapid crystallisation (Tosi *et al.*, 2004). It also presented a rapidly increased absorbance at 660 nm. Meanwhile, the F/G ratio of longan honey was higher (1.25) and no crystals were found for more than six months. Therefore, the absorbance curve presented by the crystallisation behaviour of longan honey was slower than that of sunflower honey. Laos *et al.* (2011) reported on the correlation of F/G ratio and the crystallisation time, where a higher F/G ratio presented a longer crystallisation time in eleven Estonian honey samples. These results are similar to Gleiter *et al.* (2006) which mentioned that the required time for honey to crystallise depends on the F/G ratio.

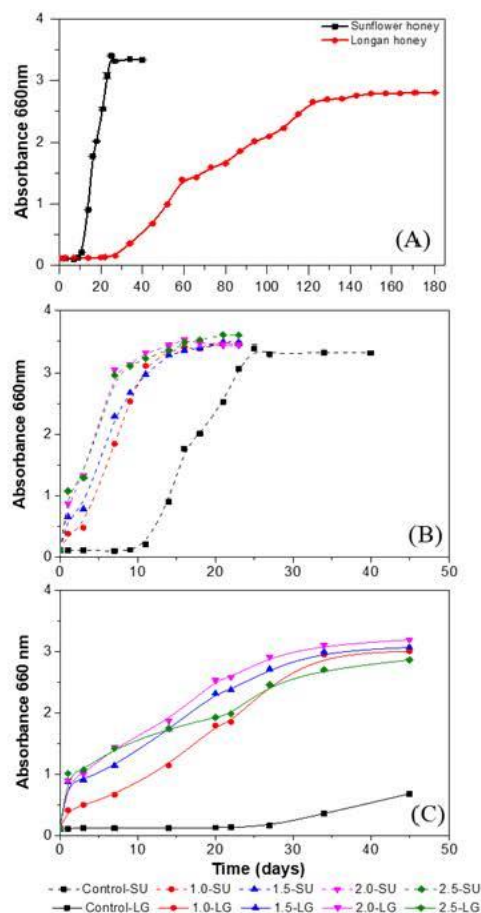

Figure 1. Absorbance at 660 nm of (A) natural crystallisation behaviour, the crystallisation behaviour was induced with glucose addition of sunflower (B), and longan honey (C) as a function of storage time.

#### Correlation between glucose addition and crystallisation behaviour

A negative correlation was found between glucose addition and the time needed until full crystallisation. An increasing amount of glucose powder added to liquid honey has led to decrease in crystallisation time.

The intensity of absorbance at 660 nm was carried out to monitor the increase in glucose crystal in honey samples during storage at chilling temperature. The results showed that we could accelerate crystallisation by adding glucose powder into both samples (Figure 1B and 1C). When absorbance or turbidity was increased, the crystallisation rate also increased, but with non-linear characteristics. It

rapidly increased in the initial phase, and when close to full crystallisation, the curve continued, particularly in sunflower honey. These results are consistent with a study by Lupano (1997). Crystallisation times of sunflower and longan honey were 39 and 81% faster, respectively, after 1.0% (w/w) of glucose was added. Meanwhile 2.0% (w/w) glucose allowed the highest crystallisation rate, where 70 and 88% were shown to be faster in sunflower and longan honey, respectively (Table 2). Longan honey, which is naturally non-crystallised honey, reached full crystallisation within 22 days after 2.0% (w/w) glucose was added, while sunflower honey only took seven days. These findings differed from the study by Elhamid and Abou-Shaara (2016) who reported that high glucose content leads to high crystallisation. The fastest crystallisation process (27 days) occurred when 1.2, 1.8, or 2.4% (w/w) powder glucose was added into clover and cotton honey. It was faster than 0.3% (66 days) and 0.6% (56 days). The fastest crystallisation time was found in sample with the highest concentration of glucose or 2.4% (w/w). Such different results might be due to the different honey types, geographical areas, and floral sources, which potentially lead to different crystallisation behaviours and the rate of crystallisation.

#### Modelling the absorbance data with Avrami model

To observe the crystallisation behaviour and compare the evolution of the crystallisation process by using the Avrami model, the equation was simulated to find the value of the crystallisation constant and ( $k$ ) Avrami index ( $n$ ). The maximum value of

absorbance at 660 nm ( $A_{660max}$ ) in each treatment was considered as the relative crystallised fraction, or  $X$  as 1. We considered an increase of the relative crystallised fraction,  $X(t)$ , during storage, following Eq. 4. The experimental data and corresponding fitted model of both honey samples are shown in Figure 2. The rate of crystallisation for all treatments in sunflower honey was not linear but seemed to be characterised by an initial fast phase followed by a slower one. The slope of the crystallisation rate plot of sunflower honey was greater after being induced with glucose powder. However, the slope became static when honey samples reached full crystallisation, or the nuclei were in the growth phase. Similar behaviour was observed by Venir *et al.* (2010). The statistical parameters ( $R^2$ ) of the Avrami model were used to compare between two types of creamed honey. The higher the  $R^2$ , the better it fitted with the model and the calculated parameters obtained by modelling the absorbance data with the Avrami model (Table 2). The statistical parameters of the Avrami model are suitable to describe the crystallisation kinetics.  $R^2$  values were high (0.818 - 0.992) in both honey samples, except for the control sample, without glucose addition. This is similar to the Avrami equation used to monitor the crystallisation kinetics of liquid honey with fine crystals added at 14°C to increase the crystallisation rate, which presented  $R^2$  values in the range of 0.924 - 0.931 (Dettori *et al.*, 2018).

The crystallization constant ( $k$ ) increased with the increase in glucose powder. When we added glucose powder at only 1.0% (w/w), the constant

Table 2. Full crystallisation time, the absorbance value at 660 nm, Avrami parameters ( $k$  and  $n$ ) with standard deviation (S.D.), and statistical parameters of crystallised honey following the addition of glucose powder at 1.0, 1.5, 2.0, and 2.5 (% w/w) to liquid sunflower and longan honey.

Sample	Treatment	Crystallisation time (day)	Absorbance value at 660 nm		$k$	$n$	$R^2$	Equation
			Day 0	at full crystallisation				
Sunflower honey	Control	23	0.115 ± 0.000 <sup>a</sup>	3.072 ± 0.047 <sup>a</sup>	1.082x10 <sup>-5</sup> ± 0.000	3.919 ± 0.307	0.991	$X = 1 - EXP(-1.082x10^{-5}t^3)$
	1.0%	14	0.385 ± 0.001 <sup>b</sup>	3.360 ± 0.008 <sup>b</sup>	0.016 ± 0.007	2.010 ± 0.196	0.992	$X = 1 - EXP(-0.016t^{2.010})$
	1.5%	14	0.661 ± 0.002 <sup>c</sup>	3.303 ± 0.008 <sup>c</sup>	0.078 ± 0.022	1.341 ± 0.133	0.986	$X = 1 - EXP(-0.078t^{1.341})$
	2.0%	7	0.877 ± 0.008 <sup>d</sup>	3.056 ± 0.005 <sup>d</sup>	0.177 ± 0.038	1.159 ± 0.123	0.984	$X = 1 - EXP(-0.177t^{1.159})$
	2.5%	9	1.082 ± 0.002 <sup>e</sup>	3.118 ± 0.007 <sup>d</sup>	0.212 ± 0.048	1.000 ± 0.117	0.976	$X = 1 - EXP(-0.212t)$
Longan honey	Control	180	0.111 ± 0.001 <sup>a</sup>	2.454 ± 0.002 <sup>a</sup>	-	-	-	-
	1.0%	34	0.412 ± 0.002 <sup>b</sup>	2.953 ± 0.004 <sup>b</sup>	0.010 ± 0.008	1.529 ± 0.267	0.956	$X = 1 - EXP(-0.01t^{1.529})$
	1.5%	34	0.878 ± 0.003 <sup>c</sup>	2.996 ± 0.002 <sup>c</sup>	0.074 ± 0.038	1.000 ± 0.182	0.930	$X = 1 - EXP(-0.074t)$
	2.0%	22	0.890 ± 0.025 <sup>c</sup>	2.580 ± 0.001 <sup>d</sup>	0.083 ± 0.039	1.000 ± 0.172	0.937	$X = 1 - EXP(-0.083t)$
	2.5%	27	1.010 ± 0.013 <sup>d</sup>	2.456 ± 0.003 <sup>e</sup>	0.075 ± 0.055	1.000 ± 0.261	0.818	$X = 1 - EXP(-0.075t)$

Data are means ± standard deviations of three replicates ( $n = 3$ ). Means followed by the different letter are significantly different between mean values ( $p \leq 0.05$ ).

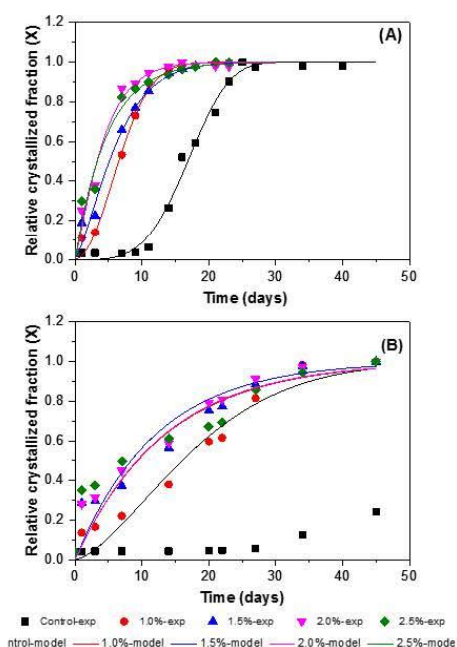

Figure 2. Experiment (exp) and modelled (model) data of relative crystallised fraction  $X(t)$  obtained with the Avrami equation of (A) sunflower honey, and (B) longan honey with glucose addition (% w/w).

constant  $k$  ( $0.016$ ) was higher than the sample without glucose addition ( $1.082 \times 10^{-5}$ ). The highest value ( $0.212$ ) was obtained in sunflower honey with  $2.5\%$  (w/w). This confirmed that the crystallisation rate could be accelerated by increasing the glucose content. Dettori *et al.* (2018) reported that the rate constant decreased with an increase in F/G ratio or reduced glucose, and the present data support this behaviour. When honey reaches the supersaturation level in the first phase, the nucleation rate is high. Based on this result, Avrami index or  $n$  values of sunflower honey ( $1.000 - 3.919$ ) were higher than those of longan honey ( $1.000 - 1.529$ ). This indicates that the crystal formation time of longan honey is longer than that of sunflower honey. Therefore, the Avrami model is a very appropriate model for describing the crystallisation behaviour from the intensity of absorbance values at  $660$  nm in sunflower and longan honey, under the condition of glucose addition. However, for further application with another honey type or any conditions, the relationship between the rate constant ( $k$ ), Avrami index ( $n$ ) and parameters of honey properties such as moisture content, initial concentration of sugar in honey, and water activity should be further considered.

### Colour

Apart from smooth texture, colour of the final product in creamed honey is also a primary indicator of consumer acceptance. The honey colour changed during crystallisation process; a good creamed honey should be light yellow in colour which results from full fine crystals.

Figures 3A to 3F report the values of brightness ( $L^*$ ), hue angle ( $h^\circ$ ), and Whiteness Index (WI) of sunflower and longan honey samples from initial time until reaching full crystallisation under chill temperature storage. Before being induced by glucose powder, sunflower honey was clear to light yellow or golden-coloured, while longan honey presented a darker yellow colour. During the crystallisation process,  $L^*$  and WI values increased in most of the samples, but rapidly changed in sunflower honey. The colour of longan honey slightly changed during storage (Figure 3D) and was similar to crystallisation behaviour.

Hue angle ( $h^\circ$ ) decreased until it reached full crystallisation, but it was not clearly changed in longan honey samples (Figure 3E). This is similar to the results of Dettori *et al.* (2018), who reported that  $h^\circ$  of fast crystallisation honey sample showed low values because it contained  $100\%$  sunflower honey which was composed of high yellow and red components, which in turn gave a darker tint or lower  $h^\circ$  as compared to slow and medium crystallisation samples. However, the colour was due to the appearance of glucose crystals reflecting the light; so, promoting the increase of brightness and a reduction of the yellow component resulted in a degree of the  $h^\circ$  in all samples. The WI of sunflower honey was higher than longan honey, but showed similar characteristics with a longer time period (Figures 3C and 3F). Costa *et al.* (2015) reported that honey samples stored at  $15^\circ\text{C}$  gained higher values than stored at  $25^\circ\text{C}$ , and exponentially increased when the time increased. This increase in WI was due to the formation of crystals in the honey. Therefore, the colour and the crystallisation rate were involved in crystal formation during the crystallisation process.

### Microstructure analysis

The crystals of honey samples in any treatment at fully crystallisation time are shown in Figures 3G and 3H. Both samples without glucose powder addition showed large, long, and sharp crystals occurrence (red and blue arrow). The crystal shape was pentagonal or hexagonal, and dispersed in single crystal. Mora-Escobedo *et al.* (2006) described the crystal appearance of Tajonal honey as a lattice with hexagonal and pentagonal crystals. The

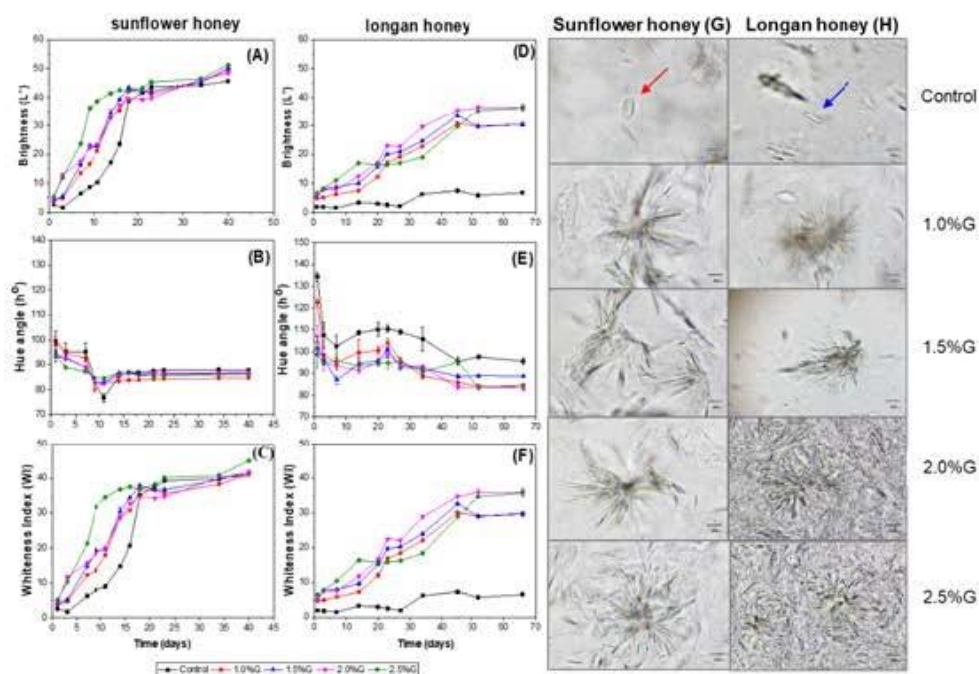

Figure 3. The  $L^*$  value, hue angle ( $h^\circ$ ), and Whiteness Index (WI) of (A) - (C) sunflower honey and (D) - (F) longan honey in different amounts of glucose powder addition during storage; and microscopic observation of honey crystals at the end of crystallisation for (G) sunflower honey and (H) longan honey.

formation of glucose monohydrate crystals will impact the crystallisation patterns, in which small needle crystals were arranged in bouquets, as described by Dettori *et al.* (2018) and Lupano (1997) who reported the crystallisation process under cooling condition.

Larger bouquets of crystals were presented in longan honey with glucose addition, and less fine crystals were found (Figure 3H). This yielded coarse grain texture. However, many fine crystals were found in sunflower honey with glucose powder addition (Figure 3G). It also had a higher density than longan honey with increasing glucose addition. It was similar to the visible appearance of both samples. In terms of quantity, shape, and appearance, the varieties of crystals depended on the compositions and amount of glucose addition in the honey samples (Table 1 and 2). Karasu *et al.* (2015) mentioned that the texture of creamed honey was spreadable like butter, and was obtained due to the presence of a large number of very fine crystals in crystallised honey. Thus, sunflower honey may be suitable for the enhanced production of creamed honey.

## Conclusion

The absorbance value at 660 nm is a good method to monitor the honey crystallisation kinetics, and the Avrami equation is a suitable model to explain the crystallisation behaviour with sunflower and longan honey when induced with glucose addition. Glucose addition impacted the crystallisation rate, colour, and crystal shape, which resulted from crystal formation during crystallization. Microstructural analysis of the small crystals found that crystals were arranged in bouquets, but were not different between treatments. Further studies should be conducted on other factors such as ultrasonic treatment and mixing temperature to control the crystallisation of creamed honey product. Storage tests in other conditions are also required.

## Acknowledgement

The authors would like to acknowledge the Thai Government Science and Technology Scholarship provided by the Ministry of Science and Technology (MOST), Thailand. Thanks too to Faculty of Engineering and Agro-Industry, Maejo University,

and Faculty of Food and Agricultural Technology, Pibulsongkram Rajabhat University for the research facilities and support.

## References

- Association of Official Analytical Chemists (AOAC). 2000. Sugars and sugar products: separation of sugars in honey. In Official Methods of Analysis of AOAC (17<sup>th</sup> ed). United States: AOAC.
- Avrami, M. 1939. Kinetics of phase change. I. General theory. The Journal of Chemical Physics 7(12): 1103-1112.
- Bogdanov, S. 2009. Harmonised methods of the international honey commission. Retrieved from International Honey Commission (IHC) website: <http://www.ihc-platform.net/ihcmethods2009.pdf>
- Briones, V. and Aguilera, J. M. 2005. Image analysis of changes in surface color of chocolate. Food Research International 38(1): 87-94.
- Chaikhram, P., Kemsawasd, V. and Apichartsrang-koon, A. 2016. Effects of conventional and ultrasound treatments on physicochemical properties and antioxidant capacity of floral honeys from Northern Thailand. Food Bioscience 15: 19-26.
- Conforti, P. A., Lupano, C. E., Malacalza, N. H., Arias, V. and Castells, C. B. 2006. Crystallization of honey at -20°C. International Journal of Food Properties 9(1): 99-107.
- Costa, L. C. V., Kaspchak, E., Queiroz, M. B., Almeida, M. M., Quast, E. and Quast, L. B. 2015. Influence of temperature and homogenization on honey crystallization. Brazilian Journal of Food Technology 18(2): 155-161.
- Dettori, A., Tappi, S., Piana, L., Rosa, M. D. and Rocculi, P. 2018. Kinetic of induced honey crystallization and related evolution of structural and physical properties. LWT 95: 333-338.
- Elhamid, A. M. A. and Abou-Shaara, H. F. 2016. Producing clover and cotton creamed honey under cooling conditions and potential use as feeding to honey bee colonies. Journal of Apiculture 31(1): 59-64.
- Gleiter, R. A., Horn, H. and Isengard, H.-D. 2006. Influence of type and state of crystallization on the water activity of honey. Food Chemistry 96(3): 441-445.
- Hagr, T. E., Mirghani, M. E. S., Elnour, A. A. H. M. and Bkharsa, B. E. 2017. Antioxidant capacity and sugar content of honey from Blue Nile State, Sudan. International Food Research Journal 24(Suppl): S452-S456.
- Jaturonglumlert, S., Varith, J. and Kiatsiriroat, T. 2015. Influence of drying methods on drying kinetics and qualities of longan fruit leather. Maejo International Journal of Science and Technology 9(1): 54-63.
- Karasu, S., Toker, O. S., Yilmaz, M. T., Karaman, S. and Dertli, E. 2015. Thermal loop test to determine structural changes and thermal stability of creamed honey: rheological characterization. Journal of Food Engineering 150: 90-98.
- Kędzierska-Matysek, M., Florek, M., Wolanciuk, A. and Skalecki, P. 2016b. Effect of freezing and room temperatures storage for 18 months on quality of raw rapeseed honey (*Brassica napus*). Journal of Food Science and Technology 53(8): 3349-3355.
- Kędzierska-Matysek, M., Florek, M., Wolanciuk, A., Skalecki, P. and Litwińczuk, A. 2016a. Characterisation of viscosity, colour, 5-hydroxymethyl-furfural content and diastase activity in raw rape honey (*Brassica napus*) at different temperatures. Journal of Food Science and Technology 53(4): 2092-2098.
- Laos, K., Kirs, E., Pall, R. and Martverk, K. 2011. The crystallization behavior of Estonian honeys. Agronomy Research 9: 427-432.
- Lupano, C. E. 1997. DSC study of honey granulation stored at various temperatures. Food Research International 30(9): 683-688.
- Mora-Escobedo, R., Moguel-Ordóñez, Y., Jaramillo-Flores, M. E. and Gutiérrez-López, G. F. 2006. The composition, rheological and thermal properties of Tajonal (*Viguiera dentata*) Mexican honey. International Journal of Food Properties 9(2): 299-316.
- Singh, I. and Singh, S. 2018. Honey moisture reduction and its quality. Journal of Food Science and Technology 55(10): 3861-3871.
- Tosi, E. A., Ré, E., Lucero, H. and Bulacio, L. 2004. Effect of honey high-temperature short-time heating on parameters related to quality, crystallization phenomena and fungal inhibition. LWT - Food Science and Technology 37(6): 669-678.
- Venir, E., Spaziani, M. and Maltini, E. 2010. Crystallization in "Tarassaco" Italian honey studied by DSC. Food Chemistry 122(2): 410-415.
- White, J. W. 1975. Composition of honey. In Crane, E. (ed). Honey: A Comprehensive Survey, p. 157-206. London: William Heinemann Ltd.



APPENDIX D  
Research Publication II



Dear author,

#### ACCEPTANCE LETTER

The Editorial Board of the International Food Research Journal (IFRJ) is pleased to inform that your manuscript has been accepted for publication.

We thank you for your contribution to IFRJ, and strongly encourage you to submit other articles to IFRJ in the near future.

Please note that accepted manuscript(s) must be accompanied by a signed Copyright Agreement Form to enable the manuscript(s) to be processed for publication. You are therefore requested to print, fill up and sign the attached Copyright Agreement Form, and return the scanned copy to [ifrj@upm.edu.my](mailto:ifrj@upm.edu.my) within three (3) working days from the date of the acceptance notification email.

Thank you.

Yours sincerely,

**Prof. Dr. Tan Chin Ping**  
Editor-in-Chief  
International Food Research Journal





**Thai Creamed Honey: Enthalpy of Crystal Melting and  
Texture Profile under Different Storage Conditions**

Journal:	<i>International Food Research Journal</i>
Manuscript ID:	IFRJ20851.R2
Manuscript Type:	Original Article
Keyword:	Differential Scanning Calorimetry, Enthalpy, creamed honey, texture, storage condition

SCHOLARONE™  
Manuscripts

1 **Thai Creamed Honey: Enthalpy of Crystal Melting and Texture Profile**  
2 **under Different Storage Conditions**

3

4 **Abstract**

5 The effects of different storage conditions of Thai creamed honey on the  
6 texture profile and thermodynamic properties were successfully investigated  
7 by using the differential scanning calorimetry (DSC) method. Liquid and  
8 creamed sunflower, longan and wild honey were used in this study due to  
9 Thailand's large production capacity, making it cheaper and improved the  
10 added value. The glass transition temperature ( $T_g$ ) and enthalpy of sugar  
11 fusion ( $\Delta H_f$ ) exhibited insignificant differences between liquid and creamed  
12 honey. Only the enthalpy of crystal melting ( $\Delta H_m$ ) was an indicator to  
13 distinguish the phase of honey, since it was imperceptible in liquid honey in  
14 the melting temperature range of 30-60°C. In addition, the correlation  
15 between hardness values and  $\Delta H_m$  can be a new parameter to control to  
16 obtain the best texture of Thai creamed honey at chilled temperature during  
17 storage.

18

19 **Keywords:** differential scanning calorimetry, enthalpy, creamed honey,  
20 texture, storage condition.

21

22 **Introduction**

23 Honey is composed of various sugars and is a supersaturated  
24 solution at normal temperatures following the glucose content. Fructose (F)

25 and glucose (G) are the main sugars in honey, while sucrose and maltose  
26 are present in tiny amounts. Glucose and fructose in honey are  
27 approximately 33-35% and 38-40%, respectively, or their total content is  
28 above 65% (w/w) of honey, and the fructose content is almost higher than  
29 the glucose content (Bhandari *et al.*, 1999). In the honey crystallisation  
30 process, glucose, which is the least soluble component of all sugars of  
31 honey, crystallises when the glucose-monohydrate form under certain  
32 conditions. Honey crystallisation is undesirable in processing, handling and  
33 marketing, and it is an unacceptable characteristic for consumer satisfaction.

34           Meanwhile, this property may be desirable for a particular purpose,  
35 such as creamed honey production. However, it is not easy to control the  
36 process, especially with various honey types in Thailand, without studying  
37 honey's physicochemical and thermal properties. According to a report of the  
38 Department of Agriculture Extension, Ministry of Agriculture and  
39 Cooperatives of Thailand, Thai honey production in 2019 was over 10,000 t,  
40 70% of which were exported and there were three types (sunflower, longan,  
41 and wild honey) which have a large production capacity in Thailand and  
42 cannot be sold at a high price. Therefore, the creamed honey product is an  
43 exciting product to increase sales value and marketing channels with honey  
44 entrepreneurs.

45           In terms of crystallised or creamed honey, liquid honey takes a  
46 semisolid state when the sugar concentration is high. The rate of  
47 crystallisation process depends on many factors such as the presence of  
48 crystallisation nuclei, the concentration of sugars that may crystallise and

49 storage temperature. Moreover, centrifuge and pumps produce small air  
50 bubbles or seeding addition, which affects the tendency of the product to  
51 crystallise (Mora-Escobedo *et al.*, 2006). However, this is an undesirable  
52 process and may cause a gritty texture of creamed honey. Cream honey with  
53 a good texture spreads like butter, and it should not drip, which can be  
54 obtained from the proper process to control the crystallisation. Thus, it should  
55 investigate an attempt to determine specific precautions to control  
56 crystallisation in creamed honey.

57 Many authors have reported the change in physicochemical and  
58 thermodynamic properties due to honey crystallisation (Conforti *et al.*, 2006;  
59 Dettori *et al.*, 2018; Lupano, 1997; Venir *et al.*, 2010), and many reports  
60 attempted to evaluate adulteration of honey by changing the enthalpy using  
61 DSC (Cordella *et al.*, 2003; Sobrino-Gregorio *et al.*, 2017). Differential  
62 scanning calorimetry (DSC) is an alternative analytical technique and a  
63 relatively fast, cheaper and environmentally friendly technique to differentiate  
64 genuine honey from adulterated honey. Lupano (1997) studied the melting  
65 enthalpy values using DSC and found it an appropriate tool to analyse the  
66 honey granulation. Besides, Tomaszewska-Gras *et al.* (2015) used DSC to  
67 investigate thermal processes in crystallised honey. DSC can be used to  
68 study most physical or chemical transformations involving heat exchanges;  
69 therefore, DSC has a very broad field of application. Even when no heat  
70 exchange occurs, as observed in glass transitions, the phenomenon causes  
71 a baseline deviation of the thermoanalytical curve related to a change in heat  
72 capacity. Moreover, DSC is a powerful tool to address the most challenging

73 issues in glass science and technology like kinetics of glass-forming systems  
74 during crystallisation (Jaturonglumlert and Kiatsiriroat, 2010; Zheng et al.,  
75 2019). Glass transition and enthalpy measurement provide detailed  
76 information about the physical and energetic properties of a substance  
77 (Cordella *et al.*, 2002), and DSC is suitable to determine the real nature of  
78 phase transitions and reveals the occurrence of thermal events. However,  
79 few publications studied a creamed honey product to our knowledge, and  
80 data of the thermodynamic properties to distinguish between liquid and  
81 creamed honey and correlate with the product appearance have not been  
82 published.

83           The consistency or texture of the final structure in creamed honey  
84 depends on the composition of the starting honey and storage temperature  
85 (Hempattarasuwan *et al.*, 2019). The temperature affects the viscosity of  
86 honey: high temperature may make the creamed honey return to the liquid  
87 form during storage, or the final hardness may vary at different storage  
88 temperatures. Therefore, the texture variation, e.g., firmness, hardness and  
89 adhesiveness, during storage should be monitored in various storage  
90 conditions to further design the optimal storage condition and determine the  
91 product's shelf-life.

92           The present work studies the thermodynamic and texture properties  
93 of creamed honey, filling the knowledge gap and providing useful data for  
94 honey processors. Different storage conditions that affect the enthalpy value  
95 in the melting transition and texture profile are also investigated.

96

97 **Material and methods**

98 *Raw material and sample preparation*

99 Sunflower, longan, and wild honey (fresh and non-crystallised honey)  
100 were purchased from Supha Bee Farm, Chiang Mai province, Thailand.  
101 Samples of 100 g were heated at 50°C to eliminate natural crystals and  
102 osmotolerant/osmophilic yeasts using a water bath. Heated honey samples  
103 were cooled to room temperature and stored in labelled glass containers at  
104 27-30°C (average temperature in Chiang Mai province, Thailand from  
105 January to March, 2020). The samples were further analysed in  
106 physicochemical and thermal properties.

107

108 *Creamed honey preparation*

109 Three types of creamed honey samples were prepared following  
110 previous research (Suriwong *et al.*, 2020) by developing from Dyce's method  
111 (Abou-Shaara and Elhamid, 2017). Liquid honey was heated with ultrasonic  
112 treatment to 50°C and rapidly cooled to 20°C. Then, seed honey was added  
113 with slow agitation at 100-300 rpm for 5 mins. The seed honey prepared from  
114 a previous batch of creamed honey preliminary test and it was separate in  
115 each honey type for preventing the honey properties' effect with creamed  
116 honey product. Next, the thoroughly mixed honey was filled into glass  
117 containers, sealed and kept at 4-10°C (Chilled temperature). The creamed  
118 honey samples remained at chilled temperature for one week prior to being  
119 stored at different temperatures (chilled and room temperature) for different  
120 storage times (7, 14, 21, and 30 days) further to analyse the

121 physicochemical, thermodynamic properties and texture. Airborne Manuka  
122 and Wildflower cream honey (New Zealand product) used in the commercial  
123 product were purchased from a supermarket in Chiang Mai province to  
124 compare the texture with a laboratory creamed honey.

125

#### 126 *Analytical*

127 Honey sugar compositions (glucose, fructose, maltose, and sucrose)  
128 were determined by HPLC (Agilent, USA) according to AOAC method 977.20  
129 (2000). The honey solution was filtered through a 0.45- $\mu$ m filter and  
130 immediately injected into an HPLC fitted with a refractive index (RI) detector.  
131 The HPLC column was a  $\mu$ -Bondapak carbohydrate column with 4-mm  
132 diameter and 300-mm length, and it was operated with the eluting solvent of  
133 acetonitrile:water (H<sub>2</sub>O) ratio of 87: 13. The sugar content in the honey  
134 samples was calculated using a standard calibration curve. We measured  
135 the moisture and sugar contents of the liquid and creamed honey samples  
136 (sunflower, longan, and wild honey) before analysing their thermal  
137 properties. The moisture content was determined using an Abbe  
138 refractometer (KRUSS, Germany). Three samples from each trial were  
139 analysed for the moisture determination, and the average moisture content  
140 was reported.

141

#### 142 *Differential Scanning Calorimetry analysis*

143 A Mettler-Toledo DSC 1 Module with the STARe software (Mettler-  
144 Toledo) was used to follow honey samples' thermal behaviour. Indium and

145 zinc standards were used to calibrate the differential scanning calorimeter,  
146 and the measuring range was extended to -65°C by a cooling Intra Cooler  
147 system. A calorimetric heat flow was used to obtain quantitative and  
148 qualitative data concerning the net heat changes produced by carbohydrates  
149 during their heating. Samples of ~10 mg of honey were placed in weighed  
150 aluminum DSC hermetic pans, and as a reference, an empty crucible was  
151 simultaneously measured. The experiments were conducted from -65 to  
152 200°C to obtain the complete thermal behaviour of pure honey and creamed  
153 honey from low temperature to high temperature. All samples were subjected  
154 to the following temperature cycle: from 25°C to -65°C; from -65°C to 200°C  
155 and held for 5 min. Various start temperatures and heating rates were applied  
156 to the samples following literature reports (Cordella *et al.*, 2002; Cordella *et*  
157 *al.*, 2003; Tomaszewska-Gras *et al.*, 2015). After evaluating the effect in the  
158 range of 2-50°C/min, we selected a heating rate of 10°C/min. The  
159 calorimetric response improved this heating rate without a decrease in  
160 accuracy, reduced the analysis time, and decreased sample degradation  
161 risk. Three DSC runs were performed to determine various glass transition  
162 temperatures ( $T_g$ ) and the samples' melting behaviour at higher  
163 temperatures to calculate the enthalpy of crystal melting ( $\Delta H_m, J/g$ ) and  
164 enthalpy of sugar fusion ( $\Delta H_f, J/g$ ).

165

#### 166 *Textural analysis*

167 Measurement was made with the TA.XT-PLUS Texture Analyzer



168 (Stable Micro Systems Ltd., UK). Test parameters were selected based on  
169 preliminary trials. A conical probe P/60C was used to penetrate a creamed  
170 honey samples to a 10-mm depth at a rate of 10 mm/s. For each sample,  
171 three replicates were analysed at each sampling time. The acquired curves  
172 of Force (N) versus time (s) shows the hardness (N) as the maximum force  
173 at the positive highest peak and the adhesiveness (N.s) as the maximum  
174 negative force area after compression.

175

#### 176 *Statistical analysis*

177 The results were expressed as the mean±standard deviation  
178 (*mean±SD*) of a triplicate test, as an independent experiment. Analysis of  
179 variance (ANOVA) used for statistical analysis, followed by Duncan's  
180 multiple range test (DMRT). The significant difference of responses at  
181  $p \leq 0.05$  analyzed by Duncan's method and statistical processing was  
182 performed using SPSS 17.

183

## 184 **Results and Discussion**

### 185 *Characterisation of liquid and creamed honey*

186 The three honey types have different compositions (Table 1) due to  
187 the floral source, climate, and environmental conditions. Pure sunflower  
188 honey (SU) has the highest glucose content (G), which is  $37.05\% \pm 4.290$  and  
189 higher than longan (LG) and wild honey (WD), which are  $32.82\% \pm 0.911$  and  
190  $31.58\% \pm 0.494$ , respectively. Sucrose (S, 0.26-0.82% (w/w)) and maltose (M,  
191 0.16-1.44% (w/w)) were present in very small amounts of these samples.

192 Moreover, as shown in Table 1, the fructose (F) per glucose ratio (F/G ratio)  
193 of liquid sunflower honey was 1.09, which was less than 1.14 (Venir *et al.*,  
194 2010). Its presence strongly shows that sunflower honey tends to initiate  
195 rapid crystallisation. The values of longan and wild honey (1.24 and 1.22,  
196 respectively) are associated with slow or no tendency to crystallise.  
197 Therefore, it is expected that the composition of liquid honey will change after  
198 a creamed honey product is produced by controlling the crystallisation  
199 process. In addition, the sample with the highest glucose content has the  
200 lowest moisture content for both liquid and creamed honey samples. The  
201 glucose per water ratio (G/W ratio) used as an indicator of crystallisation,  
202 was 1.63-2.05 (the liquid honey sample with the highest moisture content  
203 was wild honey, and the lowest moisture content was sunflower honey).  
204 Bhandari *et al.* (1999) reported that honey samples with G/W ratio above  
205 2.16 had fast crystallisation, while values below 1.70 indicate that the honey  
206 samples remain fluid for a long time. Therefore, it is expected that the  
207 creamed sunflower honey will crystallise fastest and have the highest  
208 consistency during storage. The seed addition and vigorous mixing in  
209 creamed honey production are the main factors that affect the rate of  
210 crystallisation and obtain the fine texture in creamed honey. Primary glucose  
211 microcrystals, wax, and other insoluble particles can act as catalytic factors  
212 and be naturally present; in this study, they are also called nucleation seed  
213 or primers (Dettori *et al.*, 2018). When crystallisation occurs in a controlled  
214 manner, it is possible to have products such as creamy honey.

215 To study the crystallisation process, creamed honey samples were  
216 prepared by changing honey from the liquid state to a solid one with seed  
217 addition as stimulating nuclei. All creamed honey samples have a mild  
218 flavour, spreads like butter and unlike liquid honey. It does not drip and has  
219 a creamy texture. Creamed sunflower and wild honey have a lighter yellow  
220 colour and a tighter texture than creamed longan honey. In most cases, the  
221 texture is smooth and creamy, and there is no gritty sugar, which is similar  
222 to a commercial creamed honey product.

223 The compositions of creamed sunflower (CR-SU), longan (CR-LG),  
224 and wild honey (CR-WD) are presented in Table 1. The glucose content  
225 increased from the liquid state in all honey types, while the moisture content  
226 decreased. Regarding the creamed honey is the honey product obtained  
227 from the control of honey crystallization and crystallisation in honey is the  
228 natural phenomenon that happens when glucose spontaneously precipitates  
229 out of the supersaturated honey solution. After that, the glucose loses water  
230 (becoming glucose monohydrate) and takes the form of a crystal (a solid  
231 body with a precise and orderly structure), so the glucose and water content  
232 between liquid and creamed honey presented in different content. The F/G  
233 ratios of all creamed honey samples were less than those of liquid forms for  
234 every kind; in descending order: longan, wild, and sunflower honey had F/G  
235 ratios of 1.14, 1.08, and 0.97, respectively. A lower F/G ratio corresponds to  
236 a higher crystallisation rate and more crystallised honey (Bhandari *et al.*,  
237 1999). Similarly, the G/W ratios were 2.16, 1.82, and 1.71 for creamed  
238 sunflower, longan and wild honey, respectively and increased in the liquid

239 honey samples. Therefore, the crystallisation process can be controlled by  
240 changing the honey composition. A higher glucose concentration by seed  
241 addition can consistently initiate the crystallisation in honey to obtain the  
242 creamed honey sample's smooth texture.

243

#### 244 *Thermograms of honey*

245 The thermograms in Figure 1 of liquid and creamed honey show two  
246 and three thermal phenomena in most cases, respectively.

247

#### 248 *First thermal phenomenon (I)*

249 In the first phase, i.e., glass transition, a peak appears in the range  
250 from -50 to -30°C. A glass transition can be observed at low temperatures  
251 when the material is not sufficiently ordered to crystallise. Therefore,  
252 amorphous material such as honey can be characterised by their glass  
253 transition temperature ( $T_g$ ). This phenomenon is observed in well-known  
254 honey-like polymers (Cordella *et al.*, 2002). The glass transition  
255 temperatures ( $T_g$ ) of the liquid and creamed honey samples are determined  
256 in the heating scan as the onset temperature. The liquid sunflower (-45.45°C)  
257 has significantly different glass transition temperatures with others, (longan  
258 and wild honey of -48.48°C, and -48.95°C, respectively) (Table 2). In most  
259 cases of creamed honey samples, the results of  $T_g$  were not different among  
260 honey types: -48.30, -48.55, and -49.37°C. The report's range of  $T_g$  was  
261 from -49.50 and -42.0°C, which is similar to other honey types in many

262 reports, -49.7 to -34.8°C, and -45 to -39°C (Cordella *et al.*, 2002;  
263 Tomaszewska-Gras *et al.*, 2015). Thus, when the material changes from the  
264 rubbery-like state into the rigid, glassy state upon cooling or conversely from  
265 the glassy solid to the rubbery state upon heating, the glass transition occurs.  
266 From this result,  $T_g$  is not different between pure liquid honey and creamed  
267 honey; thus, the glass transition temperature cannot be used to monitor the  
268 crystallisation process or the change in crystallisation behaviour.

269

#### 270 *Second thermal phenomenon (II)*

271 An endothermic peak appears in the temperature range of 30-60°C,  
272 which is the crystal melting transition. In Figure 1A, the peak is not present  
273 in all liquid honey samples because a peak in the thermograms corresponds  
274 to the melting of crystals in honey. There is no crystal in pure sunflower,  
275 longan, and wild honey, while the creamed honey samples consist of glucose  
276 crystals. The enthalpy of melting ( $\Delta H_m$ ) was computed from the area of the  
277 endothermic peaks in the range of 30-60°C, so the more granulated honey  
278 was the greater the recorded area. A higher glucose content corresponds to  
279 a higher enthalpy of crystal melting. Creamed sunflower honey has the  
280 highest enthalpy ( $\Delta H_m$ ) of  $2.140 \pm 0.010$  J/g due to the highest glucose  
281 content (38.30%). According to Lupano (1997), more granulated honey  
282 crystals are present with a greater peak area, and more activation energy is  
283 required to melt the crystals. Therefore, the low-temperature storage and  
284 seeding addition during the creamed honey processing may initiate the

285 nucleation process, since sugar molecules have sufficient mobility to form a  
286 crystal lattice, and the peak can be observed after seven days of storage.

287

288 *Final thermal phenomenon (III)*

289 Both liquid and creamed honey samples show a very wide and  
290 intense endothermic peak in the temperature range of 100-170°C, which is  
291 called the transition of sugar fusion. The fusion temperature of the sugars in  
292 liquid and creamed honey were begun at 83.68-118.22°C and ended at  
293 147.31-168.67°C and depended on the thermal history of the samples. This  
294 peak is similar to that in Tajonal honey in Mora-Escobedo *et al.* (2006), who  
295 reported that this peak indicated a particular composition of Tajonal honey.  
296 The observed peak in Tajonal honey samples began at 93-123°C and ended  
297 at 140–175°C, particularly the sample. (Mora-Escobedo *et al.*, 2006).  
298 Therefore, these confirmed that this range's peak represented the enthalpy  
299 for using in the melting of sugar in honey.

300 The liquid and creamed honey samples do not have a different  
301 enthalpy of sugar melting ( $\Delta H_f$ ), such as mono-, di-, tri-, and  
302 oligosaccharides. The range of the sugar-melting enthalpy is 171.24-226.35  
303 J/g. Cordella *et al.* (2003) showed the enthalpies of sugars fusions in  
304 *Lavandula*, *Robinia*, and *Fir* honey at 256.2, 213.1 and 228.9 J/g; this value  
305 did not appear as the most appropriate parameter to distinguish floral  
306 species or sugar content. However, it was essential for detecting adulteration  
307 in honey because adulterated honey has the highest enthalpies of sugar

308 fusions. Therefore, the change in enthalpy of crystal melting ( $\Delta H_m$ ) is a  
309 proper parameter to study the crystal variation of creamed honey and used  
310 to find the relation with the changes in texture during storage.

311

### 312 *Thermograms of creamed honey stored in different conditions*

313 Thermograms of creamed sunflower, longan, and wild honey in the  
314 range of crystal melting (30-60°C), stored at chilled and room temperature,  
315 are shown in Figure 2. The recorded area under the endothermic peak was  
316 observed to study the change in enthalpy of crystal melting in different  
317 storage conditions. In most types of creamed honey samples, when the  
318 storage time increased, the recorded area of the peak widened during  
319 storage at chilled temperature (Figures 2A – 2C). The endothermic peaks  
320 are due to the melting of glucose crystals, and their integration shows the  
321 relative melting enthalpy. Thus, the honey crystal dissolved, and the enthalpy  
322 of crystal melting should be decreased during storage.

323 Enthalpy values  $\Delta H_m$  (J/g), obtained by integrating the endothermic  
324 peaks, only provide information about the total amount of crystallised sugar  
325 but not the crystal dimensions. Figure 2 shows the change in enthalpy of  
326 crystal melting ( $\Delta H_m$ ) with storage time. The area under the peak or  $\Delta H_m$   
327 of creamed sunflower honey increased with storage time at chilled  
328 temperature (Figure 2A) but decreased at room temperature (Figure 2D).  
329  $\Delta H_m$  in creamed sunflower honey increased from 4.98 J/g (day 1) to 21.14  
330 J/g (day 30); similarly,  $\Delta H_m$  was 0.61 J/g (day 1), 4.66 J/g (day 30) and 0.032

331 J/g (day 1), 19.04 J/g (day 30) for creamed longan and wild honey,  
332 respectively (Figures 2B and 2C). The reason from the enthalpy value  
333 represents the amount of heat needed to melt crystals present in honey,  
334 when the amount of crystallised sugar increased when the time of chilled  
335 storage increased, so the energy for using in melting the crystal increased.  
336 This fact is consistent with Lupano (1997): the enthalpy of polyfloral honey  
337 rapidly increased when stored at 4 and 10°C, whereas the samples stored at  
338 20°C presented a slower increase.

339 The peak of creamed longan and wild honey decreased in area and  
340 sharpened when the storage time increased at room temperature (Figures  
341 2E – 2F). Similarly, creamed longan and wild honey appeared liquid during  
342 room temperature storage, which implies that their consistency decreased  
343 when the storage time increased.  $\Delta H_m$  in creamed wild honey is 13.56 and  
344 6.68 J/g on day 1 and day 30, respectively, which decreased when the  
345 storage time increased. This result is similar to the report of Zamora and  
346 Chirife (2006) and Costa *et al.* (2015), where the solubility of glucose  
347 increases and the tendency to crystallise is low when the temperature  
348 increases, and it explains the slow crystal growth in all types of honey at  
349 25°C (Costa *et al.*, 2015; Nurul Zaizuliana *et al.*, 2017; Zamora and Chirife,  
350 2006).

351

#### 352 *Texture of creamed honey stored in different conditions*

353 Regarding the crystallisation variation and textural properties that  
354 may change with temperature, to evaluate the spreadability of creamed



355 honey at various storage temperatures, textural studies were performed to  
356 obtain the parameters of hardness (N) and adhesiveness (N.s).

357 Figure 3 shows the change of hardness and adhesiveness of  
358 creamed honey samples in different storage conditions. The hardness  
359 involves the maximum force during compression (Shinn and Wang, 1990),  
360 and the adhesiveness is the maximum negative force registered during  
361 upstroke . The creamed samples' initial hardness was 9.28-13.53 N and not  
362 linearly related to the adhesiveness. Hardness increased when the storage  
363 time increased and proportionally increased with the rate of crystallisation  
364 and amount of crystallised glucose (Dettori *et al.*, 2018). The crystallisation  
365 rate in previous work depended on the glucose content and rapidly increased  
366 in sunflower honey (Suriwong *et al.*, 2020). The hardness of creamed  
367 sunflower honey rapidly increased when the storage time increased at chilled  
368 temperature, while it slowly increased for creamed longan and wild honey  
369 (Figure 3A). The hardness or firmness of creamed honey can be considered  
370 an index of the internal forces in the structure of creamed honey; the values  
371 are 115.42, 48.22, and 26.31 N for creamed sunflower, longan, and wild  
372 honey, respectively. Creamed sunflower honey presented more rigid, tighter  
373 and harder than creamed longan and wild honey. The solid texture effect due  
374 to a much greater amount of glucose. The results showed that the  
375 composition influences the rate of crystallization and the amount of glucose  
376 that crystallises also affects the final structure and, consequently, the textural  
377 properties. Thus, a larger force is required for the first compression when the  
378 crystal formation increases during storage at low temperature; i.e., the

379 crystalline phase increases, and a solid structure is formed where the  
380 crystals create a matrix, which is characterised by a cohesion that increases  
381 with time.

382 The hardness slowly changed at room temperature for creamed  
383 sunflower honey but rapidly decreased for creamed longan and wild honey,  
384 which appeared more liquid or returning to the liquid form. The hardness  
385 value decreased from 14.25 N (day 1) to 1.23 N (day 30), as shown in Figure  
386 3B. The adhesiveness decreased when the storage time increased (Figure  
387 3C) but not clearly in the storage condition of room temperature (Figure 3D).  
388 Karasu *et al.* (2015) explained this phenomenon based on the thermal loop  
389 test method: creamed honey had low thermal stability and abstained from  
390 large temperature fluctuations. They suggested that the crystallised or  
391 creamed honey should be kept at a temperature below 40°C to avoid  
392 irreversible changes in rheological or texture characters to maintain  
393 spreadability, especially creamed longan and wild honey.

394

#### 395 *Correlation between $\Delta H_m$ and hardness*

396 The creamed honey in the laboratory should present the smooth  
397 texture similar to the commercial product, the texture of the commercial  
398 product was measured to compare with our creamed honey samples. The  
399 commercial Airborne Manuka and Wildflower cream honey product was  
400 selected to represent the smooth texture product from the market, and the  
401 hardness was  $14.971 \pm 0.202$  N (green line in Figure 3A). The hardness  
402 values of creamed sunflower, longan and wild honey were  $17.382 \pm 0.306$ ,

403 18.685±2.571 and 13.382±0.624 N, respectively, on day 14, and the product  
404 had the best firmness and high consistency at a chilled temperature.  
405 Because the hardness increased with longer storage time, so the product  
406 was harder at chilled temperature and was not spreadable. Since these  
407 values were close to the commercial product's hardness value, our creamed  
408 honey samples are acceptable to consumers. There is a correlation between  
409  $\Delta H_m$  and hardness: the hardness and  $\Delta H_m$  increase when the samples are  
410 kept at a chilled temperature. On day 14,  $\Delta H_m$  were 3.673, 2.247 and 2.957  
411 J/g for creamed sunflower, longan and wild honey, respectively, at a chilled  
412 temperature. Therefore, to determine the optimal  $\Delta H_m$  of Thai creamed  
413 honey, the acceptable value of hardness can be used to estimate the  
414 enthalpy of crystal melting in creamed honey. However, honey properties  
415 and type should be considered.

416

#### 417 Conclusion

418 Thermograms obtained by differential scanning calorimetry can be  
419 used to study the thermal properties of creamed honey. The enthalpy value  
420 of crystal melting ( $\Delta H_m$ ) is an indicator to distinguish the phase of honey,  
421 which is imperceptible in liquid honey in the melting temperature range of 30-  
422 60°C.  $T_g$  and the enthalpy of sugar fusion  $\Delta H_f$  does not significantly vary  
423 for different honey types. The storage condition affects the enthalpy of crystal  
424 melting and texture properties, especially the hardness. Creamed sunflower  
425 honey can be stored at both chilled and room temperature because it

426 samples did not show a decrease in enthalpy, and the hardness did not  
427 significantly change during storage.

428           Meanwhile, the hardness of creamed longan and wild honey  
429 decreased during storage at room temperature. The hardness of creamed  
430 honey involved with the consistency of creamy texture during storage, so  
431 creamed longan and wild honey should not be stored at room temperature  
432 to prevent the creamed honey from returning to the liquid form. The positive  
433 correlation between hardness and  $\Delta H_m$  can be used to obtain the best  
434 texture of the final product.

435

#### 436 **Acknowledgements**

437           The authors would like to acknowledge Thai Government Science  
438 and Technology Scholarship support provided by the Ministry of Science and  
439 Technology (MOST), Thailand. We are grateful to Faculty of Engineering and  
440 Agro-Industry, Maejo University and Faculty of Food and Agricultural  
441 Technology, Pibulsongkram Rajabhat University for research facilities and  
442 helpful support.

443

#### 444 **References**

445 Abou-Shaara, H. and Elhamid, A. 2017. Scientific note: Effects of nuclei  
446 type on characteristics of creamed honey. *Journal of Apiculture*,  
447 32(1): 59-62.

- 448 Association of Official Analytical Chemists (AOAC). 2000. Sugars and sugar  
449 products: separation of sugars in honey. In Official Methods of  
450 Analysis of AOAC (17<sup>th</sup> ed). Gaithersburg: USA.
- 451 Bhandari, B., D'Arcy, B. and Kelly, C. 1999. Rheology and crystallisation  
452 kinetics of honey: present status. International Journal of Food  
453 Properties, 2(3): 217-226.
- 454 Conforti, P. A., Lupano, C. E., Malacalza, N. H., Arias, V. and Castells, C.  
455 B. 2006. Crystallisation of Honey at  $-20^{\circ}\text{C}$ . International Journal of  
456 Food Properties, 9(1): 99-107.
- 457 Cordella, C., Antinelli, J.-F., Aurieres, C., Faucon, J.-P., Cabrol-Bass, D. and  
458 Sbirrazzuoli, N. 2002. Use of Differential Scanning Calorimetry  
459 (DSC) as a New Technique for Detection of Adulteration in Honeys.  
460 1. Study of Adulteration Effect on Honey Thermal Behavior. Journal  
461 of Agricultural and Food Chemistry, 50(1): 203-208.
- 462 Cordella, C., Faucon, J.-P., Cabrol-Bass, D. and Sbirrazzuoli, N. 2003.  
463 Application of DSC as a tool for honey floral species characterisation  
464 and adulteration detection. Journal of thermal analysis and  
465 calorimetry, 71(1): 279-290.
- 466 Costa, L. C. V., Kaspchak, E., Queiroz, M. B., Almeida, M. M. d., Quast, E.  
467 and Quast, L. B. 2015. Influence of temperature and homogenisation  
468 on honey crystallisation. Brazilian Journal of Food Technology,  
469 18(2): 155-161.
- 470 Dettori, A., Tappi, S., Piana, L., Dalla Rosa, M. and Rocculi, P. 2018. Kinetic  
471 of induced honey crystallisation and related evolution of structural

- 472 and physical properties. *LWT-Food Science and Technology*, 95:  
473 333-338.
- 474 Hempattarasuwan, P., Settachaimongkon, S. and Duangmal, K. 2019.  
475 Impact of botanical source and processing conditions on  
476 physicochemical properties and antioxidant activity of honey in the  
477 northern part of Thailand. *International Journal of Food Science and*  
478 *Technology*, 54: 3185-3195.
- 479 Jaturonglumlert, S. and Kiatsiriroat, T. 2010. Heat and mass transfer in  
480 combined convective and far-infrared drying of fruit leather. *Journal*  
481 *of Food Engineering*, 100: 254-260.
- 482 Kántor, Z., Pitsi, G. and Thoen, J. 1999. Glass Transition Temperature of  
483 Honey as a Function of Water Content As Determined by Differential  
484 Scanning Calorimetry. *Journal of Agricultural and Food Chemistry*,  
485 47(6): 2327-2330.
- 486 Karasu, S., Toker, O. S., Yilmaz, M. T., Karaman, S. and Dertli, E. 2015.  
487 Thermal loop test to determine structural changes and thermal  
488 stability of creamed honey: Rheological characterisation. *Journal of*  
489 *Food Engineering*, 150: 90-98.
- 490 Lupano, C. E. 1997. DSC study of honey granulation stored at various  
491 temperatures. *Food Research International*, 30(9): 683-688.
- 492 Mondragón-Cortez, P., Ulloa, J. A., Rosas-Ulloa, P., Rodríguez-Rodríguez,  
493 R. and Resendiz Vázquez, J. A. 2013. Physicochemical  
494 characterization of honey from the West region of México. *CyTA -*  
495 *Journal of Food*, 11(1): 7-13.

- 496 Mora-Escobedo, R., Moguel-Ordóñez, Y., Jaramillo-Flores, M. E. and  
497 Gutiérrez-López, G. F. 2006. The Composition, Rheological and  
498 Thermal Properties of Tajonal (*Viguiera Dentata*) Mexican Honey.  
499 *International Journal of Food Properties*, 9(2): 299-316.
- 500 Nurul Zaizuliana, R., Anis Mastura, A., Abd Jamil, Z., Norshazila, S. and  
501 Zarinah, Z. 2017. Effect of storage conditions on the crystallisation  
502 behaviour of selected Malaysian honeys. *International Food*  
503 *Research Journal*, 24: S475-S480.
- 504 Shinn, J. M. and Wang, S. L. 1990. Textural Analysis of Crystallized Honey  
505 Using Response Surface Methodology. *Canadian Institute of Food*  
506 *Science and Technology Journal*, 23(4-5): 178-182.
- 507 Sobrino-Gregorio, L., Vargas, M., Chiralt, A. and Escriche, I. 2017. Thermal  
508 properties of honey as affected by the addition of sugar syrup.  
509 *Journal of Food Engineering*, 213: 69-75.
- 510 Suriwong, V., Jaturonglumert, S., Varith, J., Narkprasom, K. and Nitatwichit,  
511 C. 2020. Crystallisation behaviour of sunflower and longan honey  
512 with glucose addition by absorbance measurement. *International*  
513 *Food Research Journal*, 27(4): 727-734.
- 514 Tomaszewska-Gras, J., Bakier, S., Goderska, K. and Mansfeld, K. 2015.  
515 Differential scanning calorimetry for determining the thermodynamic  
516 properties of selected honeys. *Journal of Apicultural Science*, 59(1):  
517 109-118.
- 518 Venir, E., Spaziani, M. and Maltini, E. 2010. Crystallization in "Tarassaco"  
519 Italian honey studied by DSC. *Food Chemistry*, 122(2): 410-415.

- 520 Zamora, M. C. and Chirife, J. 2006. Determination of water activity change  
521 due to crystallisation in honeys from Argentina. *Food Control*, 17(1):  
522 59-64.
- 523 Zheng, Q., Zhang, Y., Montazerian, M., Gulbiten, O., Mauro, J. C., Zanotto,  
524 E. D. and Yue, Y. 2019. Understanding Glass through Differential  
525 Scanning Calorimetry. *Chemical Reviews*, 119(13), 7848-7939.
- 526
- 527
- 528
- 529
- 530
- 531
- 532
- 533
- 534
- 535
- 536
- 537
- 538
- 539
- 540
- 541
- 542
- 543



544 **Table 1.** Composition (g/100g) of liquid and creamed honey samples

Sample	Glucose	Fructose	Sucrose	Maltose	Water	F/G ratio	GW ratio
SU	37.05±4.290	40.51±0.216	0.54±0.091	1.44±0.091	18.00±0.250	1.09	2.05
LG	32.82±0.911	40.78±2.737	0.75±0.006	0.67±0.001	18.58±0.382	1.24	1.77
WD	31.58±0.494	38.60±0.474	0.82±0.025	0.35±0.001	19.42±0.520	1.22	1.63
CR-SU	38.30±0.033	37.25±0.216	0.63±0.031	0.16±0.050	17.75±0.289	0.97	2.16
CR-LG	33.06±0.029	37.74±0.021	0.41±0.015	0.19±0.009	18.17±0.289	1.14	1.82
CR-WD	32.20±0.018	34.67±0.010	0.26±0.006	0.19±0.007	18.83±0.144	1.08	1.71

545 \*The data are represented as *mean* ± *SD* of three replicates, and different546 letters indicate significant differences at a *p* level < 0.5 among samples.

547

548

549

550

551

552

553

554

555

556

557

558

559

560

561

562 **Table 2.** Transition temperature ( $T_{onset}$ ,  $T_{midpoint}$ ), enthalpy of crystal melting  
 563 ( $\Delta H_m$ ), peak of temperature ( $T_{peak}$ ) and enthalpy of sugars fusion ( $\Delta H_f$ ) of  
 564 liquid and creamed honey in three types: sunflower, longan and wild honey.

Sample	Thermal phenomena					
	Glass transition		Crystal melting		Fusion of sugars	
	$T_g$		$T_{onset}$	$\Delta H_m$	$T_{peak}$	$\Delta H_f$
	$T_{onset}$	$T_{midpoint}$				
SU	-45.45	-42.23	<i>N</i>	<i>N</i>	134.83	171.240±0.547 <sup>a</sup>
LG	-48.48	-45.04	<i>N</i>	<i>N</i>	124.67	199.303±1.130 <sup>b</sup>
WD	-48.95	-45.17	<i>N</i>	<i>N</i>	132.80	221.577±3.376 <sup>c</sup>
CR-SU	-48.30	-44.49	27.78	2.140±0.010 <sup>c</sup>	133.83	171.607±0.349 <sup>a</sup>
CR-LG	-48.55	-45.09	27.43	0.613±0.006 <sup>b</sup>	130.50	224.170±0.209 <sup>b</sup>
CR-WD	-49.37	-45.96	27.60	0.033±0.002 <sup>a</sup>	136.83	226.350±0.568 <sup>c</sup>

565 *N*, not measured due to absence.  $T_{onset}$ ,  $T_{midpoint}$ ,  $T_{peak}$  in °C;  $H$  in J / g

566

567

568

569

570

571

572

573

574

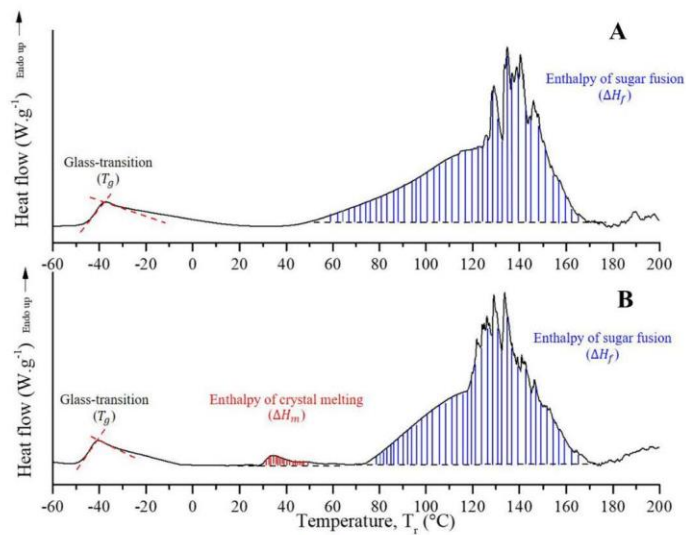

575

576 **Figure 1.** an example of DSC scan ((A) liquid and (B) creamed sunflower  
 577 honey) in the range of temperatures from -65°C to 200°C; heating rate  
 578 10°C/min.

579

580

581

582

583

584

585

586

587

588

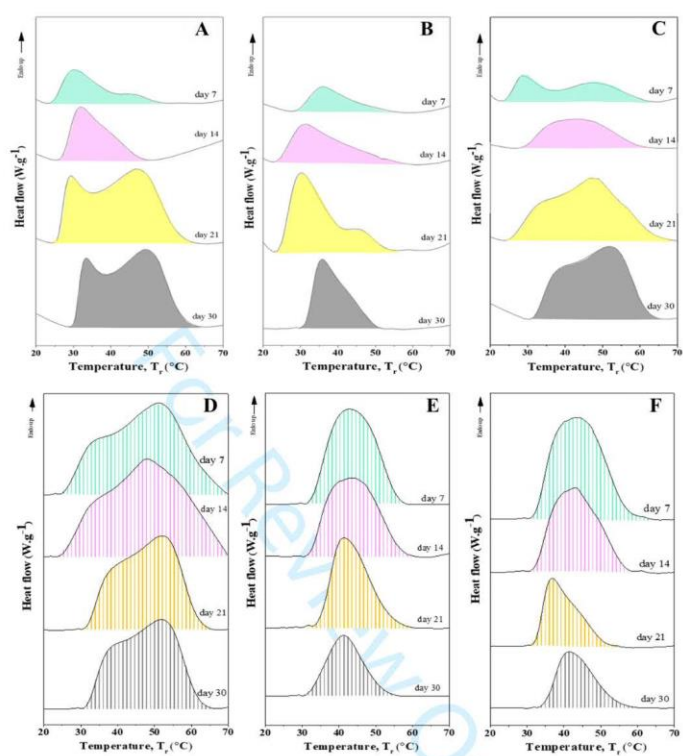

589

590 **Figure 2.** DSC thermograms of creamed honey stored in chilled (A) – (C)  
 591 and room temperatures (D) – (F). Creamed honey type: (A) and (D)  
 592 sunflower honey; (B) and (E) longan honey; (C) and (F) wild honey.

593

594

595

596

597

598

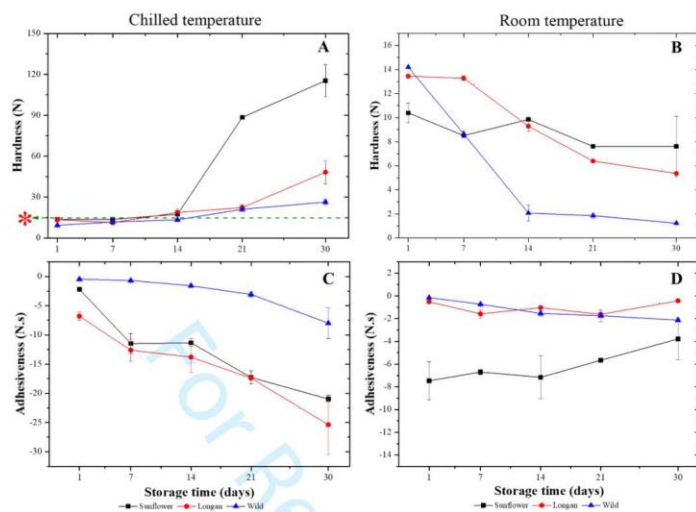

599

600 **Figure 3.** Textural parameters of (A - B) hardness, and (C - D) adhesiveness  
 601 of creamed sunflower, longan, and wild honey samples stored in chilled  
 602 temperature and room temperature.

603

604

605

606

607

608

609

610

611

612



APPENDIX E  
Research Publication III

ที่ ววบ/๒๕๖๓-๑๙๑

คณะวิทยาศาสตร์ มหาวิทยาลัยบูรพา  
ต.แสนสุข อ.เมือง จ.ชลบุรี ๒๐๑๓๑

๒๙ ธันวาคม พ.ศ. ๒๕๖๓

เรื่อง แจ้งตอบรับบทความเพื่อออกเผยแพร่ในวารสารวิทยาศาสตร์บูรพา  
เรียน คุณวรลักษณ์ สุริวงษ์, คุณสมเกียรติ จตุรงค์กล้าเลิศ, คุณพิรุณหรัศย์ ไทยสมัคร  
และ คุณสกวเดือน แก้วดำ

ตามที่ท่านได้ส่งบทความวิจัยเพื่อเข้ารับพิจารณาในวารสารวิทยาศาสตร์บูรพา บัดนี้ ขั้นตอนได้ดำเนินการเสร็จสิ้นเรียบร้อยแล้ว จึงขอแจ้งผลการตอบรับบทความ ดังนี้

บทความ ID : 3682

ชื่อเรื่องภาษาไทย : ผลของวิธีลดความชื้นต่อคุณภาพน้ำผึ้งดอกลำไย

ชื่อเรื่องภาษาอังกฤษ : Effect of Dehydration Method on Quality of Longan Honey

ฉบับที่ออกเผยแพร่ : วารสารวิทยาศาสตร์บูรพา ปีที่ ๒๖ (ฉบับที่ ๓)

กันยายน - ธันวาคม พ.ศ. ๒๕๖๔

และในโอกาสนี้กองบรรณาธิการวารสาร ฯ ขอขอบคุณที่ท่านได้ให้ความไว้วางใจในการส่งบทความเพื่อเข้ารับ  
การพิจารณา และหวังเป็นอย่างยิ่งว่าท่านจะให้ความสนใจส่งบทความในโอกาสต่อไป

จึงเรียนมาเพื่อโปรดทราบ

ขอแสดงความนับถือ

(รองศาสตราจารย์ ดร.วิชิต มั่นทะจิตร์)  
บรรณาธิการวารสารวิทยาศาสตร์บูรพา

งานวารสารวิทยาศาสตร์บูรพา

โทรศัพท์ ๐๓๘-๑๐๓๐๓๔

อีเมล buscij@buu.ac.th

เว็บไซต์ <http://science.buu.ac.th/part/buuscij/>

1 **ผลของวิธีลดความชื้นต่อคุณภาพน้ำผึ้งดอกลำไย**  
 2 **Effect of Dehydration Method on Quality of Longan Honey**

3  
4  
5  
6  
7 **บทคัดย่อ**

8 การศึกษานี้มีวัตถุประสงค์เพื่อศึกษาผลของการลดความชื้นที่มีต่อสมบัติทางกายภาพ และเคมีของน้ำผึ้งดอก  
 9 ลำไย รวมถึงศึกษาการประยุกต์ใช้แบบจำลองทางคณิตศาสตร์เพื่ออธิบายปรากฏการณ์การลดความชื้นในน้ำผึ้งดอกลำไย ผล  
 10 การศึกษาพบว่า เมื่อทำการลดความชื้นด้วยเครื่องอบแบบสุญญากาศร่วมกับอินฟราเรดที่อุณหภูมิ 30, 40, 50 และ 60 องศา  
 11 เซลเซียส สามารถลดความชื้นน้ำผึ้งดอกลำไยได้ในร้อยละ 33.33 – 42.31 ในขณะที่เมื่อนำน้ำผึ้งดอกลำไยไปลดความชื้นด้วย  
 12 เครื่องอบแบบลมร้อนจะสามารถลดความชื้นได้ร้อยละ 7.69 – 17.95 ด้วยเวลา 6 ชั่วโมงหรือ 360 นาที ซึ่งมากกว่าการลด  
 13 ความชื้นด้วยเครื่องอบแบบสุญญากาศร่วมกับอินฟราเรดถึง 36 เท่า ผลการวิเคราะห์คุณภาพน้ำผึ้งหลังการลดความชื้น พบว่า  
 14 ที่อุณหภูมิ 40 องศาเซลเซียส นาน 20 นาที เป็นสภาวะที่เหมาะสมสำหรับการลดความชื้นด้วยเครื่องอบระบบสุญญากาศ  
 15 ร่วมกับอินฟราเรด โดยให้ค่าสี ( $L^*$ ,  $a^*$  และ  $b^*$ ) และค่าปริมาณน้ำอิสระ ( $a_w$ ) ไม่แตกต่างจากน้ำผึ้งก่อนลดความชื้น ( $p < 0.05$ )  
 16 อีกทั้งยังเป็นการปรับสัดส่วนกลูโคสต่อน้ำในน้ำผึ้งเริ่มต้นให้เหมาะสมต่อการนำไปผลิตครีมน้ำผึ้งดอกลำไยได้ และเมื่อใช้  
 17 แบบจำลองทางคณิตศาสตร์อธิบายปรากฏการณ์การลดความชื้นที่ 40 องศาเซลเซียส พบว่าแบบจำลองทางคณิตศาสตร์ของ  
 18 Newton's model และ Page's model สามารถใช้อธิบายปรากฏการณ์การลดความชื้นน้ำผึ้งดอกลำไยได้ทั้งแบบสุญญากาศ  
 19 ร่วมกับอินฟราเรดและแบบอบลมร้อน แต่ทั้งนี้สภาวะการลดความชื้นในน้ำผึ้งแต่ละชนิดย่อมแตกต่างกันไปขึ้นอยู่กับสมบัติ  
 20 ทางกายภาพและเคมีของน้ำผึ้งเป็นหลัก

21  
22 **คำสำคัญ** : น้ำผึ้งดอกลำไย ; การลดความชื้น ; เครื่องอบแบบสุญญากาศร่วมกับอินฟราเรด ; เครื่องอบแบบลมร้อน

23  
24 **Abstract**

25 This research aimed to study the effect of moisture dehydration on physicochemical properties of longan  
 26 honey and try to explain the dehydration mechanism of longan honey by mathematical model. The results showed  
 27 that the dehydration with vacuum - infrared drying at temperatures of 30, 40, 50 and 60°C removed the moisture  
 28 content in by 33.33 – 42.31%. On the other hand, moisture content of honey was removed by 7.69 - 17.95% using  
 29 the hot air drying with drying time up to 6 hours, more than dehydration with a vacuum - infrared drying up to 36  
 30 times. At 40°C, 20 mins dehydration with vacuum – infrared drying provided color ( $L^*$ ,  $a^*$ ,  $b^*$ ) and water activity ( $a_w$ )  
 31 not significantly different from honey sample before moisture dehydration ( $p < 0.05$ ) and could adjust glucose/water  
 32 ratio in raw material preparation for creamed honey production. The  $R^2$  values indicates the Newton's and Page's



33 models fit reasonably well with the experimental data, so it was to be a good model for describing the moisture  
 34 reduction in longan honey with both method at 40°C. However, the conditions of dehydration in each type of honey  
 35 differ, it depends on the physical and chemical properties of honey.

36  
 37 **Keywords :** Longan honey ; Dehydration ; Vacuum-infrared drying ; Hot air drying

38

39 **\*Corresponding author. E-mail :**

40

#### 41 บทนำ

42 น้ำผึ้ง (Honey) คือ ผลผลิตของน้ำหวานจากดอกไม้และจากแหล่งอื่น ๆ ที่ผึ้งงานนำมาเก็บสะสมไว้ ซึ่งปกติแล้วน้ำผึ้ง  
 43 จะมียุคสั้น รส สี ที่ต่างกันออกไปตามชนิดของพืชนั้น ๆ จึงทำให้สามารถระบุชนิดของน้ำผึ้งตามชนิดของพืชนั้น ๆ ได้ เช่น ดอก  
 44 ลำไย ดอกทานตะวัน ก็จะแตกต่างกันออกไป ซึ่งนิยมนำมาใช้เป็นสารให้ความหวานในอาหารหรือเครื่องดื่ม น้ำผึ้งมีส่วนผสม  
 45 ของน้ำตาลและสารประกอบอื่น ๆ ซึ่งส่วนใหญ่จะเป็นฟรุกโทสกับกลูโคส รวมทั้งวิตามินและแร่ธาตุผสมอยู่ด้วย (Singh &  
 46 Singh, 2018) สำหรับสารประกอบอื่น ๆ ที่มีอยู่ในปริมาณเพียงน้อยนิดนั้นจะเป็นสารที่ทำหน้าที่ช่วยต่อต้านอนุมูลอิสระเป็น  
 47 หลัก ทำให้น้ำผึ้งถูกนำมาเป็นส่วนผสมของผลิตภัณฑ์อาหารมากมายทั้งในอุตสาหกรรมอาหาร ยา และเครื่องสำอาง  
 48 นอกจากนี้ น้ำผึ้งยังได้รับความนิยมบริโภคและทำรายได้ให้กับประเทศไทยมากที่สุด คือ น้ำผึ้งดอกลำไย โดยมีกำลังการผลิต  
 49 มากถึง 10,000 ตันต่อปี และมีการเลี้ยงผึ้งมากที่สุดในภาคเหนือ สัดส่วนร้อยละ 89.38 ของปริมาณการผลิตผึ้งทั้งหมด โดย  
 50 จังหวัดที่มีการเลี้ยงมากที่สุด คือ จังหวัดเชียงใหม่ แต่ทั้งนี้พบว่าผู้ผลิตน้ำผึ้งยังต้องแบกรับต้นทุนการผลิตไว้สูง เมื่อเทียบกับ  
 51 ราคาขายที่จำหน่ายได้ นอกจากนี้ผู้บริโภคส่วนใหญ่ยังไม่มั่นใจในการซื้อน้ำผึ้งเพื่อบริโภคด้วยเหตุผลเรื่องของการปลอมปน  
 52 ของน้ำผึ้ง โดยทั่วไปการนำน้ำผึ้งมาบริโภคโดยตรงนั้น จะมีอยู่ 2 ลักษณะ คือ น้ำผึ้งเหลวที่มีความหนืดสูง และน้ำผึ้งที่มี  
 53 ลักษณะเป็นผลึก เรียกว่า ผลึกน้ำผึ้ง เนื่องจากน้ำผึ้งเป็นสารละลายที่อิ่มตัวไปด้วยกลูโคสและฟรุกโทส และผลึกที่เห็นในน้ำผึ้ง  
 54 จะเป็นผลึกของกลูโคสโมโนไฮเดรต ซึ่งมีความสามารถในการละลายต่ำกว่าน้ำตาลชนิดอื่นที่มีอยู่ในน้ำผึ้งจึงสามารถเกิดเป็น  
 55 ผลึกได้ก่อนน้ำตาลชนิดอื่น ดังนั้น เมื่ออัตราส่วนของน้ำตาลกลูโคสต่อน้ำ (Glucose/Water ratio, G/W ratio) อัตราส่วนของ  
 56 ฟรุกโทสต่อกลูโคส (Fructose/Glucose ratio, F/G ratio) สมบัติการดูดความชื้น ความหนืดของน้ำผึ้งเปลี่ยนไป และทำให้  
 57 น้ำผึ้งดังกล่าวมีความเข้มข้นสูงขึ้นจะส่งผลให้ปริมาณกลูโคสที่มีในน้ำผึ้งอยู่ในระดับของสารละลายอิ่มตัวยิ่งจึงมีการตก  
 58 ผลึกขึ้นได้ โดยการตกผลึกของน้ำผึ้งนี้ไม่ได้หมายความว่าน้ำผึ้งเกิดการเสื่อมคุณภาพ เพียงแต่เปลี่ยนสภาพและลักษณะที่  
 59 ปรากฏเท่านั้น (Assil *et al.*, 1991) ผลิตภัณฑ์จากน้ำผึ้งที่ทำลึกลงเป็นที่นิยมและยังขาดข้อมูลด้านการวิจัยเป็นอย่างมาก คือ  
 60 ครีมน้ำผึ้งพร้อมรับประทาน แต่การพัฒนาครีมน้ำผึ้งให้มีเนื้อสัมผัสที่ดียังเป็นไปได้ยาก และบ่อยครั้งที่ผู้ประกอบการพยายาม  
 61 ที่จะผลิตครีมน้ำผึ้งจากกระบวนการตกผลึกในรูปแบบต่าง ๆ แต่พบว่า เนื้อสัมผัสที่ได้เป็นเนื้อทราย มีผลึกน้ำผึ้งเป็นเกร็ด เกิด  
 62 การแยกชั้นในระหว่างการเก็บรักษา ซึ่งปัจจัยที่มีผลต่อการให้ได้เนื้อครีมที่ดีนั้นมีหลากหลายปัจจัย ไม่ว่าจะเป็นสมบัติเริ่มต้น  
 63 ของน้ำผึ้ง อุณหภูมิในการตกผลึก อัตราการเกิดผลึก รวมถึงผลึกตั้งต้นที่เติมผสม โดยเฉพาะสมบัติเริ่มต้นของน้ำผึ้งที่ไม่เอื้อต่อ  
 64 การตกผลึกหรือทำให้เกิดการตกผลึกเป็นครีมน้ำผึ้งได้ยาก (Suriwong *et al.*, 2020) ดังนั้น ทางผู้วิจัยจึงเล็งเห็นแนวทางการ  
 65 ผลิตครีมน้ำผึ้งจากน้ำผึ้งดอกลำไยเพื่อเพิ่มมูลค่าผลิตภัณฑ์น้ำผึ้งดอกลำไย แต่เนื่องจากน้ำผึ้งดอกลำไยเป็นน้ำผึ้งที่จัดอยู่ใน

66 กลุ่มที่มีแนวโน้มในการตกผลึกช้าหรือไม่เกิดการตกผลึก แม้จะเก็บไว้ในที่เย็นเป็นระยะเวลาสั้น เนื่องจากมีปริมาณความชื้น  
 67 สูงและกลูโคสต่ำ หรือมีปริมาณสัดส่วนกลูโคสต่อน้ำตาลต่ำกว่า 1.70 (Bhandari *et al.*, 1999; White Jr, 1975; Conforti *et al.*,  
 68 2006) ดังนั้น ทางผู้วิจัยจึงมีความสนใจที่จะศึกษาหาแนวทางการลดปริมาณน้ำหรือความชื้นในน้ำผึ้งดอกกล้วย เพื่อเร่งให้เกิด  
 69 การตกผลึกได้ไวขึ้นและเพื่อพัฒนาต่อเป็นผลิตภัณฑ์ครีมน้ำผึ้งดอกกล้วยต่อไปในอนาคต ซึ่งจะได้มีการศึกษาผลของการลด  
 70 ความชื้นต่อสมบัติทางกายภาพและเคมีของน้ำผึ้ง รวมถึงศึกษาการอธิบายปรากฏการณ์การลดความชื้นในน้ำผึ้งดอกกล้วย  
 71 ด้วยแบบจำลองทางคณิตศาสตร์ ซึ่งจะช่วยให้ผู้ประกอบการผลิตภัณฑ์น้ำผึ้งสามารถนำไปพัฒนาและประยุกต์ในการ  
 72 ออกแบบกระบวนการผลิตและพัฒนาผลิตภัณฑ์ใหม่เพื่อเพิ่มมูลค่าต่อไป

73

#### 74 **วิธีดำเนินการวิจัย**

##### 75 **1. การเตรียมตัวอย่างน้ำผึ้ง**

76 น้ำผึ้งดอกกล้วยที่เก็บในช่วงเดือนสิงหาคม – ตุลาคม 2562 จากสุภาพาร์มผึ้ง อำเภอแรมเมิง จังหวัดเชียงใหม่ มีสี  
 77 น้ำตาลคล้ำกับสีของน้ำผึ้งดอกกล้วยที่จำหน่ายในท้องตลาดจึงถูกเลือกนำมาใช้เป็นตัวอย่างทดลองในงานวิจัยนี้ ซึ่งน้ำหนัก  
 78 และแบ่งบรรจุในขวดแก้วประมาณ 30 กรัม ย่างละ 3 ขวดต่อรีพรีเมนต์ (ดังภาพที่ 1) ทำการลดความชื้นเปรียบเทียบด้วย 2  
 79 วิธีการ คือ แบบสุญญากาศร่วมกับอินฟราเรดที่ความดัน 5 กิโลปาสคาล (เครื่องอบแห้งแบบสุญญากาศร่วมกับอินฟราเรด  
 80 มหาวิทยาลัยแม่โจ้) และแบบอบลมร้อน (ตู้อบลมร้อนยี่ห้อ Memmert, Germany) ที่อุณหภูมิ 30, 40, 50 และ 60 องศา  
 81 เซลเซียส นำมาวิเคราะห์คุณภาพทางกายภาพและเคมีตัวอย่างน้ำผึ้งทั้งก่อนและหลังทำการลดความชื้น

##### 82 **2. การวิเคราะห์คุณภาพทางกายภาพและเคมี**

83 วิเคราะห์ปริมาณน้ำตาลกลูโคสและฟรุกโตส โดยใช้เครื่องแยกของเหลวสมรรถนะสูง (HPLC) ตามวิธี Official  
 84 method 977.20 (AOAC, 2000)

85 วิเคราะห์หาค่าปริมาณน้ำอิสระ ( $a_w$ ) ด้วยเครื่อง  $a_w$  meter ยี่ห้อ Aqua Lab, series 3TE และวิเคราะห์หาค่าความชื้น  
 86 ด้วยวิธีการ Refractive index method (Bogdanov, 2009) โดยวัดค่า Refractive index ด้วยเครื่อง Digital Abbe  
 87 refractometer (KRUSS, Germany)

88 วิเคราะห์หาค่าสีด้วยเครื่อง Spectrophotometer (Hunter Lab, Mini Scan XE Plus) โดยตรวจสอบค่าสีด้วยระบบ  
 89 CIE และวิเคราะห์ค่าสีเป็น  $L^*$ ,  $a^*$  และ  $b^*$  พร้อมคำนวณหาค่า  $h^\circ$  และ  $C^*$

##### 90 **3. การศึกษาแบบจำลองทางคณิตศาสตร์ที่เหมาะสมของการลดความชื้น**

91 วัดค่าความชื้นน้ำผึ้งที่เปลี่ยนไปตามเวลาการลดความชื้นจนกระทั่งค่าความชื้นคงที่หรือ น้ำผึ้งเปลี่ยนสภาพไปจนไม่  
 92 สามารถวัดค่าความชื้นได้ วัดออกมาเป็นค่าร้อยละฐานเปียก แล้วคำนวณค่าเป็นสัดส่วนความชื้น (Moisture Ratio, MR) ดัง  
 93 สมการที่ (1)

94

$$95 \quad MR = \frac{M - M_{eq}}{M_m - M_{eq}} \quad (1)$$

96

97 เมื่อ  $M$  คือ ปริมาณความชื้นที่เวลาใดๆของน้ำผึ้ง ( $Q_{water} / Q_{solid}$ ),  $M_{eq}$  คือ ปริมาณความชื้นสมดุลหรือคงที่  
 98 (Equilibrium moisture content),  $M_0$  คือ ปริมาณความชื้นเริ่มต้น โดยในการทดลองกำหนดให้  $M_{eq}$  มีค่าเมื่อความชื้นเข้าสู่จุด  
 99 สมดุลหรือเมื่อน้ำผึ้งเปลี่ยนสภาพจนไม่สามารถวัดค่าความชื้นได้

100 ความสัมพันธ์ระหว่างสัดส่วนความชื้นของน้ำผึ้งดอกลำไยกับเวลาในการลดความชื้น ถูกนำมาใช้เปรียบเทียบกับ  
 101 ค่าที่ทำนายได้จากสมการทางคณิตศาสตร์กรอบแห่งของ Newton's model, Page's model และ Modified Page's model  
 102 (Basri *et al.*, 2012; Kaewdam *et al.*, 2013) ดังแสดงดังสมการที่ (2) - (4)

104 Newton's model:  $MR = \exp(-kt)$  (2)

105 Page's model:  $MR = \exp(-kt^n)$  (3)

106 Modified Page's model  $MR = \exp((-kt)^n)$  (4)

107  
 108 โดยนำผลการทดลองมาวิเคราะห์ด้วยเทคนิคสมการถดถอยแบบไม่เชิงเส้น (Nonlinear regression analysis) เพื่อ  
 109 เลือกแบบจำลองที่เหมาะสมที่สุด โดยให้ค่าการวิเคราะห์สมการถดถอย ( $R^2$ ) สูงที่สุด และ Root Means Square Error  
 110 (RMSE) และ Chi-square ( $\chi^2$ ) ต่ำที่สุด

#### 111 4. การวิเคราะห์ทางสถิติ

112 ออกแบบการทดลองแบบ Full Factorial Design แสดงข้อมูลการทดลองเป็นค่าเฉลี่ย  $\pm$  ค่าเบี่ยงเบนมาตรฐาน  
 113 (mean $\pm$ S.D.) จากการทดลองจำนวน 3 ซ้ำ ทำการวิเคราะห์ความแปรปรวนของข้อมูลด้วยวิธี Analysis of Variance (ANOVA)  
 114 และวิเคราะห์ความแตกต่างด้วยวิธี Duncan's Multiple Range Test (DMRT) ด้วยโปรแกรม SPSS 17 ที่ระดับความเชื่อมั่น  
 115 ร้อยละ 95 ค่าความแปรปรวนสมการถดถอย ( $R^2$ ) ใช้คำนวณเพื่อประเมินความถูกต้องของแบบจำลองทางคณิตศาสตร์ที่ใช้ใน  
 116 การอธิบายการลดความชื้นในน้ำผึ้ง

#### 118 ผลการวิจัย

##### 119 1. คุณภาพทางกายภาพและเคมีของน้ำผึ้งดอกลำไย

120 เมื่อสังเกตด้วยตาเปล่าตัวอย่างน้ำผึ้งดอกลำไยมีสีน้ำตาลเข้ม มีความใส ไม่ขุ่น ไม่มีผลึกตกตะกอนในขวด เมื่อนำมา  
 121 วิเคราะห์องค์ประกอบทางชีวเคมีของน้ำผึ้งดอกลำไย แสดงผลดังตารางที่ 1 พบว่า น้ำผึ้งดอกลำไยมีค่าความชื้นร้อยละ 19.50  
 122 ค่าปริมาณของแข็งคือร้อยละ 78.68 และปริมาณน้ำอิสระ ( $a_w$ ) เท่ากับ  $0.562 \pm 0.009$  เมื่อพิจารณาว่าปริมาณน้ำตาลที่เป็น  
 123 องค์ประกอบในน้ำผึ้งดอกลำไย พบว่า น้ำผึ้งดอกลำไยมีปริมาณฟรุกโตสสูงกว่ากลูโคส โดยมีปริมาณฟรุกโตสร้อยละ 41.56  
 124 ส่วนปริมาณกลูโคสมีร้อยละ 33.31 โดยทั่วไปน้ำผึ้งจะเกิดการตกผลึกเนื่องจากมีปริมาณกลูโคสที่มากพอจนถึงจุดอิ่มตัว  
 125 (Saturated solution of glucose) หรือความชื้นในน้ำผึ้งมีน้อย ในที่นี้ น้ำผึ้งดอกลำไยมีปริมาณน้ำตาลฟรุกโตสมากกว่ากลูโคส  
 126 ถึง 1.25 เท่า (Fructose per Glucose ratio, F/G ratio) และมีค่าอัตราส่วนกลูโคสต่อความชื้น (Glucose per Water ratio,  
 127 G/W ratio) เท่ากับ  $1.70 \pm 0.001$  จากงานวิจัยเกี่ยวกับน้ำผึ้งระบุว่า ถ้าน้ำผึ้งมีค่า F/G มากกว่า 1.14 (Bhandari *et al.*, 1999;  
 128 Suriwong *et al.*, 2020; White, 1975) หรือมี G/W ratio น้อยกว่า 1.70 จัดเป็นน้ำผึ้งที่มีแนวโน้มการตกผลึกได้ยากหรือไม่เกิด

129 การตกผลึก จึงทำให้น้ำผึ้งดอกกล้วยไม้จัดเป็นน้ำผึ้งประเภทที่มีแนวโน้มที่จะไม่เกิดการตกผลึกหรือเกิดการตกผลึกได้ยากใน  
 130 ระหว่างการเก็บรักษา ซึ่งหากจะนำไปพัฒนาต่อเป็นครีมน้ำผึ้งจากการตกผลึกแบบควบคุม จำเป็นจะต้องปรับองค์ประกอบ  
 131 ทางชีวเคมีให้น้ำผึ้งดอกกล้วยไม้สามารถเกิดการตกผลึกได้ง่ายหรือเร็วขึ้น

132

133 **ตารางที่ 1** องค์ประกอบทางชีวเคมีของน้ำผึ้งดอกกล้วยไม้

คุณสมบัติ	ค่าที่วัดได้
ความชื้น (ร้อยละ)	19.50 ± 0.05
ปริมาณของแข็งทั้งหมด (ร้อยละ)	78.68 ± 0.05
ค่าปริมาณน้ำอิสระ (a <sub>w</sub> )	0.56 ± 0.01
กลูโคส (ร้อยละ)	33.31 ± 1.03
ฟรุกโตส (ร้อยละ)	41.56 ± 2.14
สัดส่วนฟรุกโตสต่อกลูโคส (F/G ratio)	1.25 ± 0.02
สัดส่วนกลูโคสต่อน้ำ (GW ratio)	1.70 ± 0.01
L*	3.376 ± 0.152
a*	0.566 ± 0.235
b*	0.893 ± 0.405
Hue angle (h°)	125.229 ± 18.993
Chroma (C*)	1.099 ± 0.295

134 **หมายเหตุ:** ข้อมูลแสดงเป็นค่าเฉลี่ย ± ส่วนเบี่ยงเบนมาตรฐาน (mean ± S.D.)

135

136 ผลการวิเคราะห์ค่าสี จะเห็นได้ว่า ค่า L\* หรือค่าความสว่าง (brightness) ของน้ำผึ้งดอกกล้วยไม้จากสุภาพาร์มผึ้งมีค่า  
 137 เท่ากับ 3.376±0.152 ค่า a\* เข้าใกล้สีแดง มีค่าเท่ากับ 0.566 ± 0.235 และค่า b\* มีค่าเข้าใกล้สีเหลืองเท่ากับ 0.893 ± 0.405  
 138 ทำให้น้ำผึ้งดอกกล้วยไม้มีลักษณะสีน้ำตาลแดงค่อนข้างดำมาทางสีน้ำตาลเข้ม เมื่อทำการคำนวณหาค่า h° และ C\* แล้วพบว่า ค่า  
 139 h°(hue angle) เท่ากับ 125.229 ± 18.993 ซึ่งอยู่ในตำแหน่งระหว่าง 90° – 180° ให้ค่าสีอยู่ระหว่างสีเหลืองถึงสีเขียว และค่า  
 140 C\*(Chroma) เท่ากับ 1.099 ± 0.295 ที่เกิดจากความมันวาวของน้ำผึ้ง ดังภาพที่ 1

141



142

143 **ภาพที่ 1** ลักษณะภายนอกของน้ำผึ้งดอกกล้วยก่อนทำการลดความชื้น

144

145 **2. ผลการศึกษากลยุทธ์การลดความชื้นของน้ำผึ้ง**

146 จากภาพที่ 2 จะเห็นได้ว่า เมื่อทำการลดความชื้นน้ำผึ้งดอกกล้วยด้วยเครื่องอบแบบสูญญากาศร่วมกับอินฟราเรดที่  
 147 ความดัน 5 กิโลปาสคาล จะสามารถลดความชื้นที่อุณหภูมิ 40, 50 และ 60 องศาเซลเซียส ได้เพียง 10 – 15 นาทีเท่านั้น  
 148 เนื่องจากผิวหน้าของน้ำผึ้งมีความแห้งและเหนียวจนไม่สามารถวัดค่าความชื้นต่อได้ พบว่า ที่อุณหภูมิ 50 และ 60 องศา  
 149 เซลเซียส เวลา 10 นาที ค่าความชื้นลดลงจากเริ่มต้นเฉลี่ยร้อยละ 19.50±0.25 เหลือเฉลี่ยเท่ากับร้อยละ 11.75±0.35 และ  
 150 12.15±0.21 และที่อุณหภูมิ 40 องศาเซลเซียส ค่าความชื้นที่เวลา 20 นาที เหลือเฉลี่ยเท่ากับร้อยละ 12.00±0.00 ในขณะที่เมื่อ  
 151 ทำการลดความชื้นที่อุณหภูมิ 30 องศาเซลเซียส ปริมาณความชื้นในน้ำผึ้งจะมีลักษณะค่อย ๆ ลดลงอย่างต่อเนื่องและใช้ระยะ  
 152 เวลานานถึง 60 นาที น้ำผึ้งจึงปรากฏผิวหน้าแห้งและมีค่าความชื้นเฉลี่ยเท่ากับร้อยละ 13.00±0.24

153

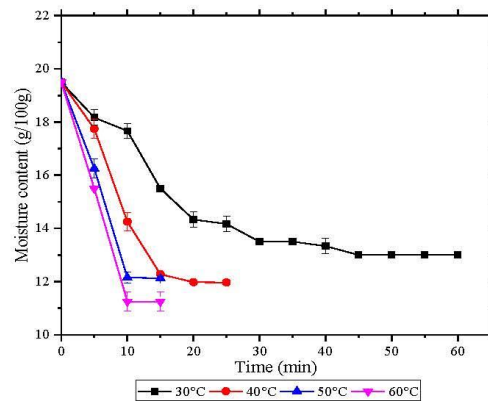

154 **ภาพที่ 2** การเปลี่ยนแปลงความชื้นของน้ำผึ้งดอกกล้วยด้วยเครื่องอบแบบสูญญากาศร่วมกับอินฟราเรด อุณหภูมิ 30, 40, 50  
 155 และ 60 องศาเซลเซียส ที่ความดัน 5 กิโลปาสคาล

156

157 ลักษณะการเปลี่ยนแปลงความชื้นในน้ำผึ้งเมื่อผ่านการลดความชื้นด้วยเครื่องอบแบบสูญญากาศร่วมกับอินฟราเรด  
 158 ที่ความดัน 5 กิโลปาสคาล พบว่า เมื่อทำการเพิ่มอุณหภูมิการลดความชื้นในช่วงแรกที่เป็นช่วงของการปรับสภาวะเบื้องต้น  
 159 (Initial adjustment period) น้ำในน้ำผึ้งยังมีอยู่มาก จึงเกิดการถ่ายเทความร้อนระหว่างตัวกลางลมร้อนกับน้ำผึ้ง ค่าความชื้น  
 160 ในช่วงนี้จะมีค่าลดลง ต่อมาเป็นช่วงอัตราการลดความชื้นคงที่ (Constant rate period) ช่วงนี้น้ำในน้ำผึ้งจะมีการระเหยออก  
 161 อย่างรวดเร็วภายในเวลาอันสั้น คือ 10 - 20 นาที จนกระทั่งผิวหน้าน้ำผึ้งเริ่มแห้ง จะเข้าสู่ช่วงอัตราการอบแห้งลดลง หรือ  
 162 เส้นกราฟความชื้นเริ่มคงที่หรือเข้าสู่สมดุล ซึ่งในการลดความชื้นที่อุณหภูมิ 50 และ 60 องศาเซลเซียส พบว่า ในช่วงนี้น้ำผึ้งเริ่ม  
 163 มีลักษณะแห้ง และสีคล้ำ ในขณะที่เมื่อทำการลดความชื้นที่อุณหภูมิ 30 องศาเซลเซียส ยังคงสภาพคล้ายน้ำผึ้งก่อนลด  
 164 ความชื้นแต่พบว่า ค่าความชื้นไม่สามารถลดลงได้อีก แม้จะเพิ่มระยะเวลาการลดความชื้นนานถึง 60 นาที

165

166

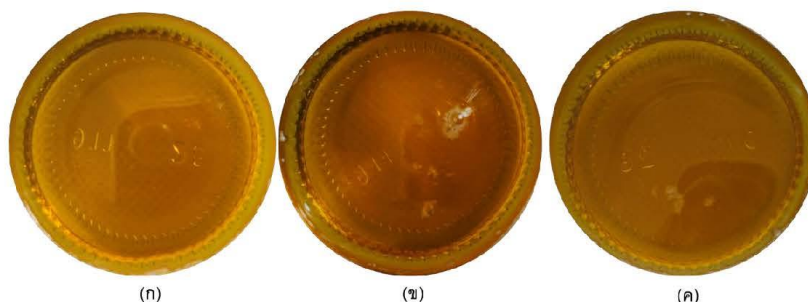

167

168

169

170

171

172

173

174

175

176

177

178

179

180

181

182

ภาพที่ 3 ลักษณะน้ำผึ้งดอกลำไย (ก) ก่อนทำการลดความชื้น (ข) ลดความชื้นแบบสุญญากาศร่วมกับอินฟราเรด 40°C เวลา 20 นาที (ค) ลดความชื้นแบบอบลมร้อน 40°C เวลา 360 นาที

เมื่อพิจารณาจากค่าความชื้น ค่าสี และ ค่าปริมาณน้ำอิสระของเปรียบเทียบก่อนลดความชื้นและสิ้นสุดการลดความชื้นของแต่ละอุณหภูมิ (ตารางที่ 2) พบว่า ที่อุณหภูมิ 30 องศาเซลเซียส 60 นาที มีปริมาณน้ำอิสระ ( $0.514 \pm 0.002$ ) ไม่แตกต่างจากน้ำผึ้งก่อนลดความชื้น แต่แตกต่างกับการลดความชื้นที่ 40, 50 และ 60 องศาเซลเซียส ( $p < 0.05$ ) โดยมีค่าลดลงเท่ากับ  $0.372 \pm 0.003$ ,  $0.380 \pm 0.004$  และ  $0.352 \pm 0.002$  ตามลำดับ นอกจากนี้พบว่า เมื่อเพิ่มอุณหภูมิการลดความชื้นให้สูงขึ้นที่ 50 และ 60 องศาเซลเซียส จะทำให้น้ำผึ้งมีสีคล้ำหรือมีค่าความสว่าง ( $L^*$ ) ลดลงและแตกต่างกับก่อนลดความชื้น ( $p < 0.05$ ) เท่ากับ  $1.51 \pm 0.32$  และ  $1.33 \pm 0.03$  ตามลำดับ เช่นเดียวกับการลดความชื้นที่อุณหภูมิ 30 องศาเซลเซียสที่ทำให้น้ำผึ้งมีสีคล้ำมากขึ้นเช่นกัน โดยมีค่า  $L^*$  เท่ากับ  $1.87 \pm 0.16$  เนื่องจากการลดความชื้นที่อุณหภูมิต่ำเวลานานจะส่งผลให้น้ำผึ้งมีสีคล้ำมากขึ้นได้ ในขณะที่การลดความชื้นที่ 40 องศาเซลเซียส นาน 20 นาที มีค่า  $L^*$  ไม่แตกต่างกับน้ำผึ้งก่อนลดความชื้น ( $p > 0.05$ ) มีค่าเท่ากับ  $2.85 \pm 0.14$

ตารางที่ 2 ผลการวิเคราะห์คุณภาพของน้ำผึ้งเปรียบเทียบก่อนและหลังสิ้นสุดการลดความชื้น แบบสุญญากาศร่วมกับอินฟราเรดที่ความดัน 5 กิโลปาสคาล และแบบอบลมร้อน ที่อุณหภูมิ 30, 40, 50 และ 60 องศาเซลเซียส

ระบบการลดความชื้น	อุณหภูมิ (°C)	ค่าสี			ค่าปริมาณน้ำอิสระ ( $a_w$ )
		$L^*$	$a^*$	$b^*$	
Control		$3.56 \pm 0.17^c$	$0.71 \pm 0.84^b$	$-0.77 \pm 0.39^c$	$0.562 \pm 0.009^c$
Vacuum	30°C, 60 นาที	$1.87 \pm 0.16^b$	$-0.79 \pm 0.82^a$	$0.69 \pm 0.87^d$	$0.514 \pm 0.002^c$
	40°C, 20 นาที	$2.85 \pm 0.14^c$	$-0.31 \pm 0.27^a$	$-1.14 \pm 0.47^c$	$0.372 \pm 0.003^b$
Infrared Dehydration	50°C, 10 นาที	$1.51 \pm 0.32^a$	$-0.56 \pm 0.22^a$	$-3.45 \pm 0.56^b$	$0.380 \pm 0.004^b$
	60°C, 10 นาที	$1.33 \pm 0.03^a$	$-0.40 \pm 0.28^a$	$-7.21 \pm 0.07^a$	$0.352 \pm 0.002^a$
Hot Air Oven	30°C, 360 นาที	$3.47 \pm 0.05^c$	$1.17 \pm 0.62^b$	$1.57 \pm 0.35^a$	$0.365 \pm 0.001^d$

40°C, 360 นาที	3.04±0.02 <sup>a</sup>	1.21±0.72 <sup>b</sup>	1.46±0.23 <sup>a</sup>	0.352±0.001 <sup>b</sup>
50°C, 360 นาที	3.17±0.09 <sup>ab</sup>	1.18±0.40 <sup>b</sup>	0.44±0.23 <sup>b</sup>	0.348±0.001 <sup>a</sup>
60°C, 360 นาที	3.27±0.21 <sup>b</sup>	0.78±0.51 <sup>b</sup>	1.23±0.61 <sup>a</sup>	0.351±0.002 <sup>b</sup>

183 **หมายเหตุ:** - ข้อมูลแสดงเป็นค่าเฉลี่ย ± ส่วนเบี่ยงเบนมาตรฐาน (mean ± S.D.) ตัวเลขในแนวตั้งที่มีตัวอักษรกำกับต่างกัน แตกต่างกันอย่างสถิติ  
184 (p<0.05)

185 - Control หมายถึง ตัวอย่างน้ำผึ้งดอกกล้วยที่ไม่ผ่านการลดความชื้น

186

187 นอกจากนี้ยังเห็นได้ว่า แม้ทำการลดความชื้นที่อุณหภูมิ 50 และ 60 องศาเซลเซียส จะทำให้ความชื้นลดลงได้มากใน  
188 เวลาอันสั้นที่ 10 นาที แต่เมื่อทำการลดความชื้นต่อไปจนค่าความชื้นคงที่พบว่า น้ำผึ้งได้เกิดการเสียสภาพ คือ น้ำผึ้งมีลักษณะ  
189 แห้ง เหนียวข้นและลักษณะภายนอกเป็นสีน้ำตาลคล้ำ ซึ่งไม่เหมาะต่อการนำไปพัฒนาเป็นครีมน้ำผึ้งดอกกล้วยต่อไปได้

190

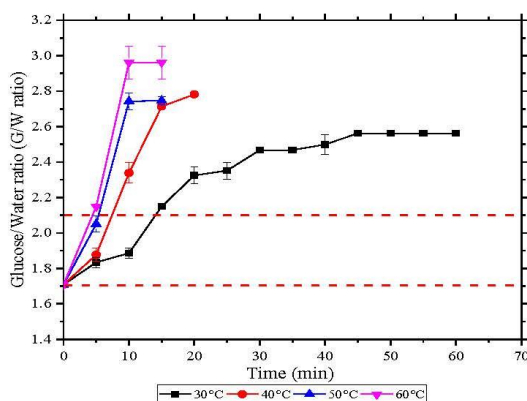

191

192

192 **ภาพที่ 4** กราฟแสดงความสัมพันธ์ระหว่างสัดส่วนน้ำตาลกลูโคสต่อน้ำ (G/W ratio) กับเวลา ด้วย

193

193 เครื่องอบแบบสูญญากาศร่วมกับอินฟราเรดที่อุณหภูมิ 30, 40, 50 และ 60 องศาเซลเซียส

194

195 เมื่อสร้างความสัมพันธ์ระหว่างสัดส่วนน้ำตาลกลูโคสต่อน้ำ (Glucose/Water ratio, G/W ratio) กับเวลาการลด  
196 ความชื้น (ภาพที่ 4) พบว่า ค่า G/W ratio มีค่าเพิ่มขึ้นจากเดิมที่มีค่าเฉลี่ยเท่ากับ 1.708±0.007 หรืออยู่ในช่วงการตกผลึกได้  
197 ยาก เมื่อความชื้นลดลง ทำให้ค่า G/W ratio เพิ่มขึ้นจนมีค่ามากกว่า 2.10 ที่ทำให้น้ำผึ้งมีแนวโน้มที่จะเกิดการตกผลึกขึ้นได้  
198 (เส้นประสีแดง) โดยพบว่า เมื่อทำการลดความชื้นที่อุณหภูมิ 30 องศาเซลเซียส ค่า G/W ratio จะเพิ่มขึ้นถึงจุดที่เหมาะสมที่  
199 เวลา 30 นาที ในขณะที่เมื่อลดความชื้นที่อุณหภูมิ 40, 50 และ 60 องศาเซลเซียส จะทำให้น้ำผึ้งมีค่า G/W ratio เพิ่มขึ้นถึงจุดที่  
200 เหมาะสมต่อการตกผลึกได้ที่เวลา 10, 10 และ 5 นาที ตามลำดับ

201

201 ต่อมาได้ศึกษาเปรียบเทียบการลดความชื้นน้ำผึ้งดอกกล้วยด้วยเครื่องอบแบบลมร้อนที่ระดับอุณหภูมิเดียวกัน (ภาพที่  
202 5) พบว่า ลักษณะการเปลี่ยนแปลงความชื้นเป็นไปอย่างช้า ๆ และต่อเนื่องเมื่อเวลาการลดความชื้นเพิ่มขึ้น ค่าความชื้นลดลง

203 จากเริ่มต้น ( $19.50 \pm 0.00$ ) เหลือเท่ากับร้อยละ  $18.00 \pm 0.01$ ,  $17.00 \pm 0.00$ ,  $16.00 \pm 0.01$  และ  $16.00 \pm 0.01$  ที่อุณหภูมิ 30, 40,  
 204 50 และ 60 องศาเซลเซียส นาน 360 นาที ตามลำดับ (ภาพที่ 2) จะเห็นได้ว่า เมื่อทำการลดความชื้นด้วยเครื่องอบลมร้อนจะ  
 205 ลดความชื้นน้ำผึ้งลงได้มากที่สุด ร้อยละ 3.50 ที่อุณหภูมิ 50 และ 60 องศาเซลเซียส แต่ทั้งนี้พบว่า ค่า  $L^*$ ,  $a^*$  และ  $b^*$  และ  
 206 ค่า  $a_w$  ภายหลังจากลดความชื้นที่ทุกสภาวะอุณหภูมิแตกต่างกันทางสถิติ ( $p < 0.05$ ) เมื่อเทียบกับน้ำผึ้งดอกกล้วยก่อนทำการลด  
 207 ความชื้น (ตารางที่ 2)  
 208

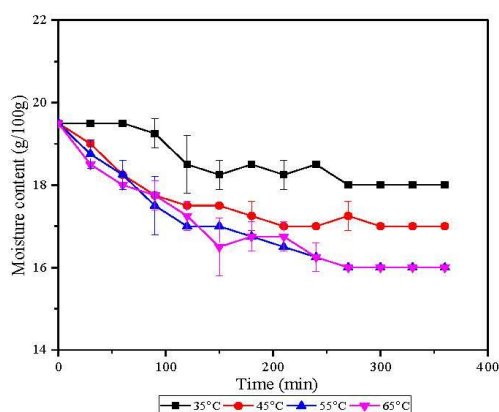

209  
 210 **ภาพที่ 5** การเปลี่ยนแปลงความชื้นของน้ำผึ้งดอกกล้วยด้วยเครื่องอบแบบลมร้อน อุณหภูมิ 30, 40, 50 และ 60 องศาเซลเซียส  
 211

212 และเมื่อสร้างความสัมพันธ์ระหว่าง GW ratio ที่เปลี่ยนไปตามเวลาที่ทำการลดความชื้นด้วยเครื่องอบแบบลมร้อน จะ  
 213 ให้ลักษณะการเปลี่ยนแปลงดังแสดงภาพที่ 6 ผลการสร้างความสัมพันธ์พบว่า เมื่อทำการลดความชื้นด้วยเครื่องอบแบบลม  
 214 ร้อน จะทำให้ค่า GW ratio เปลี่ยนแปลงเพิ่มขึ้นไปอย่างช้า ๆ และแม้จะทำการลดความชื้นด้วยระยะเวลาที่นานถึง 360 นาที  
 215 ก็ยังไม่สามารถทำให้สัดส่วน GW ratio เพิ่มขึ้นถึงระดับ 2.10 (เส้นประสีแดง) ที่จะทำให้น้ำผึ้งมีสมบัติที่จะเกิดการตกผลึกได้  
 216 อย่างรวดเร็วเมื่อเก็บรักษาในระยะเวลาที่นานขึ้นได้ (White, 1974) หรือมีสมบัติที่ไม่เหมาะสมต่อการนำไปใช้เป็นผลิตภัณฑ์  
 217 น้ำผึ้งตั้งต้นในการผลิตครีมน้ำผึ้งดอกกล้วยในอนาคตได้  
 218



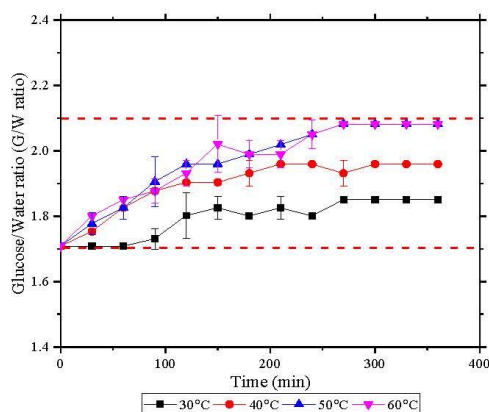

219  
220 **ภาพที่ 6** กราฟแสดงความสัมพันธ์ระหว่างสัดส่วนน้ำตาลกลูโคสต่อน้ำ (G/W ratio) กับเวลา ด้วยเครื่องอบแบบลมร้อน ที่  
221 อุณหภูมิ 30, 40, 50 และ 60 องศาเซลเซียส

222  
223 เมื่อทำการเปรียบเทียบวิธีการลดความชื้นระหว่างการลดความชื้นด้วยเครื่องอบแบบสุญญากาศร่วมกับอินฟราเรด  
224 และเครื่องอบแบบลมร้อน (ตารางที่ 3) จะเห็นได้ว่า เมื่อทำการลดความชื้นด้วยเครื่องอบแบบสุญญากาศร่วมกับอินฟราเรด  
225 ความดัน 5 กิโลปาสคาล ที่อุณหภูมิ 30, 40, 50 และ 60 องศาเซลเซียส จะสามารถลดความชื้นน้ำฝัสดอกกล้วยได้ในสัดส่วน  
226 ร้อยละ 33.33 – 42.31 ในขณะที่เมื่อนำน้ำฝัสดอกกล้วยไปผ่านการลดความชื้นด้วยเครื่องอบแบบลมร้อนจะสามารถลด  
227 ความชื้นลงได้เพียงร้อยละ 7.69 – 17.95 รวมถึงต้องใช้ระยะเวลาในการลดความชื้นนานถึง 6 ชั่วโมงหรือ 360 นาที ซึ่งมากกว่า  
228 การลดความชื้นด้วยเครื่องอบแบบสุญญากาศร่วมกับอินฟราเรดถึง 36 เท่า

229  
230 **ตารางที่ 3** ค่าความชื้น (ร้อยละ) เปรียบเทียบที่แต่ละระดับอุณหภูมิระหว่างการลดความชื้นแบบสุญญากาศร่วมกับ  
231 อินฟราเรด (Vacuum Infrared Dehydration) และแบบลมร้อน (Hot Air Oven)

ระบบการลด ความชื้น	อุณหภูมิ (°C)	เวลา (นาที)	ค่าความชื้น (ร้อยละ)		ร้อยละความชื้นที่ลดได้
			ก่อน	หลัง	
Vacuum Infrared Dehydration	30	60	19.50±0.00	13.00±0.00	33.33±0.02
	40	15	19.50±0.00	11.96±0.02	38.64±0.02
	50	10	19.50±0.00	12.13±0.11	37.79±0.02
	60	10	19.50±0.00	11.25±0.35	42.31±0.02
Hot Air Oven	30	360	19.50±0.00	18.00±0.00	7.69±0.02
	40	360	19.50±0.00	17.00±0.01	12.82±0.02
	50	360	19.50±0.00	16.00±0.00	17.95±0.02
	60	360	19.50±0.00	16.00±0.00	17.95±0.02

232 **หมายเหตุ:** ข้อมูลแสดงเป็นค่าเฉลี่ย  $\pm$  ส่วนเบี่ยงเบนมาตรฐาน (mean  $\pm$  S.D.)

233

234 และเมื่อพิจารณาจากค่าสัดส่วน GW ratio ในน้ำผึ้งดอกกล้วยเปรียบเทียบกับระหว่างการลดความชื้นแบบสุญญากาศ  
235 ร่วมกับอินฟราเรดที่ความดัน 5 กิโลปาสคาลและแบบอบลมร้อน พบว่า ที่การลดความชื้นแบบสุญญากาศร่วมกับอินฟราเรด  
236 ความดัน 5 กิโลปาสคาล ที่อุณหภูมิ 40 องศาเซลเซียส เวลา 10 นาที จะทำให้ได้ค่า GW ratio ในน้ำผึ้งมากกว่า 2.10 ซึ่งจะทำให้  
237 ให้น้ำผึ้งปรับสภาพทำให้เกิดการตกผลึกได้เร็วขึ้น ในขณะที่เมื่อลดความชื้นแบบอบลมร้อนทุกอุณหภูมิเป็นเวลา 6 ชั่วโมงหรือ  
238 360 นาที ไม่สามารถทำให้ค่า GW ratio เพิ่มสูงขึ้นมากกว่าค่าการตกผลึกได้ ผู้วิจัยจึงเห็นว่า เพื่อสามารถอธิบายปรากฏการณ์  
239 การลดความชื้นในน้ำผึ้ง ทางผู้วิจัยจึงได้นำแบบจำลองทางคณิตศาสตร์การอบแห้งมาประยุกต์ใช้เพื่อเป็นข้อมูลในการ  
240 ออกแบบกระบวนการผลิตครีมน้ำผึ้งต่อไปได้

241

### 242 3. แบบจำลองการลดความชื้นของน้ำผึ้งดอกกล้วย

243 เมื่อพิจารณาจากแนวโน้มการลดลงของความชื้นในน้ำผึ้งดอกกล้วยที่สภาวะที่เหมาะสมที่สุด คือ 40 องศาเซลเซียส  
244 (เปรียบเทียบระหว่างแบบสุญญากาศร่วมกับอินฟราเรดที่ความดัน 5 กิโลปาสคาล และแบบอบลมร้อน) จึงได้นำแบบจำลอง  
245 ทางคณิตศาสตร์ 3 แบบจำลอง ได้แก่ Newton, Page และ Modified Page model มาเปรียบเทียบค่าที่ทำนายกับค่าที่ได้จาก  
246 การทดลอง จะได้พารามิเตอร์ (k และ n) ดังแสดงตารางที่ 4

247

248 **ตารางที่ 4** ค่าคงที่ของสมการการลดความชื้นของน้ำผึ้งดอกกล้วยที่ได้จากแบบจำลอง Newton's, Page's และ Modified  
249 Page's model เปรียบเทียบระหว่างการลดความชื้นแบบสุญญากาศร่วมกับอินฟราเรดและแบบอบลมร้อน ที่อุณหภูมิ 40  
250 องศาเซลเซียส

Dehydration method	Model	Equation	k	n	R <sup>2</sup>	RMSE	$\chi^2$
Vacuum	Newton	$\exp(-0.119t)$	0.119	-	0.945	0.005674	$3.40 \times 10^{-5}$
	Infrared	$\exp(-0.007t^{2.219})$	0.007	2.219	1.000	0.000035	0.0000
Dehydration	Modified Page	$\exp(-0.024t)$	0.024	1.0	0.455	0.173533	0.0010
Hot Air Oven	Newton	$\exp(-0.012t)$	0.012	-	0.977	0.002279	$1.30 \times 10^{-5}$
	Page	$\exp(-0.004t^{1.229})$	0.004	1.229	0.985	0.001669	$1.00 \times 10^{-5}$
	Modified Page	$\exp(-0.01t)$	0.010	1.0	0.825	0.004705	$2.80 \times 10^{-5}$

251

252 ผลการศึกษาพบว่า แบบจำลองทางคณิตศาสตร์ของ Newton's model มีค่า R<sup>2</sup> สูงสุด เท่ากับ 1.000 และ 0.985 เมื่อ  
253 ทำการลดความชื้นแบบสุญญากาศร่วมกับอินฟราเรดและแบบอบลมร้อน ตามลำดับ และมีค่า R<sup>2</sup> เท่ากับ 0.945 และ 0.977  
254 เมื่อทำนายด้วยแบบจำลองทางคณิตศาสตร์ของ Page's model ในขณะที่แบบจำลองของ Modified Page ให้ค่า R<sup>2</sup> ต่ำที่สุด  
255 เท่ากับ 0.455 และ 0.825 (ภาพที่ 7)

256 ดังนั้น แบบจำลองทางคณิตศาสตร์ของ Newton's และ Page's model มีความเหมาะสมในการอธิบายปรากฏการณ์  
 257 การลดความชื้นที่อุณหภูมิ 40 องศาเซลเซียส เมื่อลดความชื้นด้วยเครื่องสุญญากาศร่วมกับอินฟราเรดและเครื่องอบลมร้อน ซึ่ง  
 258 จะสามารถนำไปใช้ทำนายลักษณะการลดความชื้นของน้ำผึ้งดอกลำไย และเป็นประโยชน์ต่อผู้ประกอบการในอนาคตได้  
 259

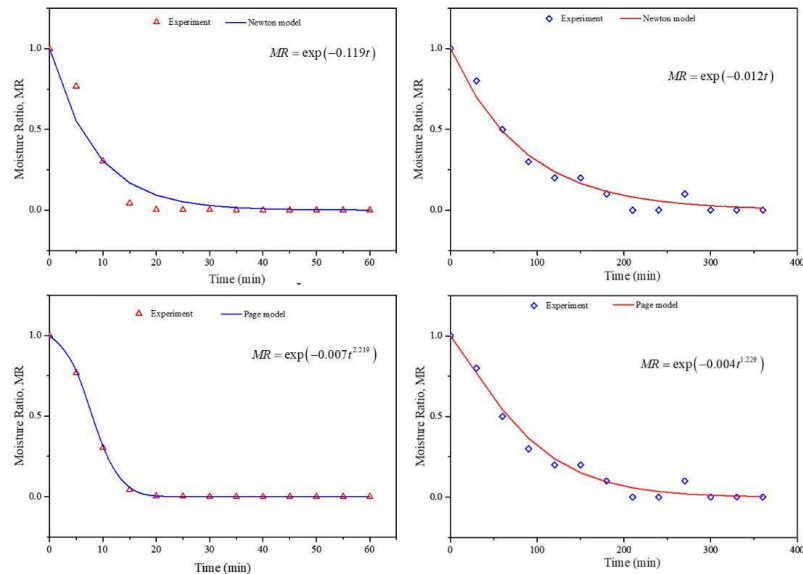

260

261

ก) ลดความชื้นแบบสุญญากาศร่วมกับอินฟราเรด

ข) ลดความชื้นแบบอบลมร้อน

262

ภาพที่ 7 ผลของการใช้แบบจำลองทางคณิตศาสตร์ของ Newton's model และ Page's model ในการลดความชื้น

263

(ก) แบบสุญญากาศร่วมกับอินฟราเรด (ข) แบบอบลมร้อน ที่อุณหภูมิ 40 องศาเซลเซียส

264

### 265 วิจัยผลการวิจัย

266 จากการศึกษาสมบัติทางกายภาพและเคมีของน้ำผึ้งดอกลำไย พบว่า ค่าปริมาณของแข็งในน้ำผึ้งจะแปรผกผันกับ  
 267 ความชื้น แต่ปริมาณน้ำอิสระ ( $a_w$ ) จะแปรผันตามปริมาณความชื้น โดยเมื่อน้ำผึ้งมีปริมาณความชื้นมาก ค่า  $a_w$  จะมากตามไป  
 268 ด้วย ซึ่งค่าที่ได้มีความสอดคล้องกับค่า  $a_w$  ของน้ำผึ้งดอกลำไยที่ตรวจวัดได้ในรายงานของ Hempattarasuwan *et al.* (2019)  
 269 ที่มีค่าอยู่ในช่วง 0.59 – 0.63 เมื่อสังเกตด้วยตาเปล่าจะเห็นว่า น้ำผึ้งดอกลำไยมีสีน้ำตาลค่อนข้างเข้ม เมื่อพิจารณาค่า  $L^*$  หรือ  
 270 ค่าความสว่าง (brightness) มีค่าเท่ากับ  $3.376 \pm 0.152$  ซึ่งเมื่อเปรียบเทียบกับน้ำผึ้งดอกทานตะวันจากจังหวัดลพบุรีใน  
 271 งานวิจัยของ Prissawong (2005) น้ำผึ้งดอกทานตะวันจะมีสีเหลืองค่อนข้างอ่อนไปทางสีเหลืองทอง มีค่า  $L^*$  ที่มากกว่า ( $4.17$   
 272  $\pm 0.02$ ) นอกจากนี้จะเห็นได้ว่า ค่า  $a^*$  และ  $b^*$  มีค่าเป็นบวก แสดงว่า น้ำผึ้งมีสีออกแดงและเหลือง จึงสอดคล้องกับงานวิจัยที่  
 273 เคยศึกษามา ที่ให้ค่า  $a^*$  และ  $b^*$  เป็นค่าบวกเช่นกัน โดยมีค่าอยู่ในช่วง 7.11 – 10.08 และ 4.87 – 5.11 ตามลำดับ  
 274 (Hempattarasuwan *et al.*; 2019, Prissawong, 2005) รวมถึงเมื่อดูจากลักษณะภายนอกพบว่า น้ำผึ้งดอกลำไยจากจังหวัด

275 เชียงใหม่และจังหวัดลพบุรี มีลักษณะสีน้ำตาลแดงก่อนมาทางสีน้ำตาลเข้ม ซึ่งมีลักษณะคล้ายกับน้ำผึ้งดอกลำไยจากสุภา  
276 ฟาร์มผึ้งที่ทำการศึกษา

277 นอกจากนี้โดยทั่วไปน้ำตาลที่พบในน้ำผึ้งมาก คือ กลูโคสและฟรุกโตส และอาจพบมอลโตส หรือซูโครสได้เพียงเล็กน้อย  
278 โดยองค์การอาหารและยาในประเทศไทยได้กำหนดไว้ว่า น้ำผึ้งแท้ควรมีซูโครสเจือปนอยู่ไม่เกินร้อยละ 5 และมาตรฐานฟาร์ม  
279 โดยทั่วไปกำหนดไม่เกินร้อยละ 1.0 – 1.5 (Ministry of Public Health, 2000) ซึ่งจากผลวิเคราะห์ปริมาณกลูโคสและฟรุกโตส  
280 ในน้ำผึ้งดอกลำไย พบว่า น้ำผึ้งดอกลำไยมีปริมาณฟรุกโตสสูงกว่ากลูโคส โดยมีปริมาณฟรุกโตสร้อยละ 41.56 ส่วนปริมาณ  
281 กลูโคสร้อยละ 33.31 ทั้งนี้ปริมาณน้ำตาลอาจมีความแตกต่างกันไปแม้จะเป็นน้ำผึ้งชนิดเดียวกัน แต่เกี่ยวข้องกับช่วงฤดูกาลที่  
282 ต่างกัน หรือเป็นสายพันธุ์ดอกไม้ที่ต่างกัน ดังจะเห็นได้จากรายงานของ Hemptarasuwan *et al.* (2019) ที่พบว่า น้ำผึ้งดอก  
283 ลำไยจากสุภาฟาร์มผึ้ง จังหวัดเชียงใหม่กับน้ำผึ้งดอกลำไยที่เก็บเกี่ยวโดยตรงจากอำเภอท่าวังผา จังหวัดน่าน มีปริมาณ  
284 น้ำตาลฟรุกโตสและกลูโคสอยู่ในช่วงร้อยละ 21.13 – 22.56 และร้อยละ 30.26 – 31.24 ตามลำดับ ซึ่งต่างจากค่าวิเคราะห์ได้  
285 ในรายงานวิจัยนี้ แต่ไม่ว่าจะเป็นค่าความชื้น ปริมาณฟรุกโตสและปริมาณกลูโคสที่มีในน้ำผึ้ง ทุกปัจจัยล้วนส่งผลต่อการตก  
286 ผลึกในน้ำผึ้งได้ในลักษณะที่แตกต่างกัน

287 น้ำผึ้งที่มีปริมาณกลูโคสมากจะเกิดการตกผลึกได้เร็ว เนื่องจากกลูโคสมีความสามารถในการละลายต่ำกว่าฟรุกโตส  
288 (Zamora & Chirife, 2006) และผลึกที่เกิดขึ้นคือผลึกของกลูโคสบริสุทธิ์ (Escobedo *et al.* 2006) จากรายงานการวิจัยใน  
289 ต่างประเทศพบว่า มีหลายปัจจัยที่เป็นสาเหตุให้น้ำผึ้งเกิดการตกผลึก เช่น เมื่อมีอัตราส่วนฟรุกโตสต่อกลูโคส (F/G ratio) น้อย  
290 กว่า 1.14 และมีอัตราส่วนกลูโคสต่อความชื้น (GW ratio) มากกว่าหรือเท่ากับ 2.10 (White Jr., 1974) จากผลวิเคราะห์ที่  
291 แสดงไว้ในตารางที่ 1 พบว่า น้ำผึ้งดอกลำไยมีอัตราส่วน F/G และมีอัตราส่วน GW มีค่าเท่ากับ 1.25±0.02 และ 1.70±0.01  
292 ตามลำดับ จึงทำให้น้ำผึ้งดอกลำไยจัดเป็นน้ำผึ้งที่มีโอกาสการตกผลึกได้ยากหรือไม่เกิดการตกผลึกในระหว่างการเก็บรักษาได้  
293 ทางผู้วิจัยจึงเลือกที่จะทำการศึกษานาแนวทางการลดความชื้นน้ำผึ้งดอกลำไยด้วยเครื่องอบแห้งแบบสุญญากาศร่วมกับ  
294 อินฟราเรดที่ความดัน 5 กิโลปาสคาล เปรียบเทียบกับเครื่องอบแห้งแบบลมร้อนที่อุณหภูมิ 30, 40, 50 และ 60 องศาเซลเซียส  
295 เพื่อใช้เป็นแนวทางในการพัฒนาเป็นผลิตภัณฑ์ครีมน้ำผึ้งต่อไป

296 ลักษณะการเปลี่ยนแปลงความชื้นของน้ำผึ้งดอกลำไยด้วยเครื่องอบแบบสุญญากาศร่วมกับอินฟราเรดที่ความดัน 5  
297 กิโลปาสคาล พบมีการลดลงในช่วงการปรับสถานะเบื้องต้น และต่อมาจะลดลงอย่างรวดเร็วในระยะเวลา 10 – 20 นาที ซึ่งเป็น  
298 ช่วงอัตราการลดความชื้นคงที่ ลักษณะดังกล่าวมีความสอดคล้องกับงานวิจัยของ Shu Khang Yap *et al.* (2019) ที่  
299 ทำการศึกษาผลของการลดความชื้นในน้ำผึ้ง *Kelulut* ที่อุณหภูมิ 40, 55 และ 70 องศาเซลเซียส โดยค่าความชื้นในน้ำผึ้งจะ  
300 ลดลงอย่างรวดเร็วในช่วงแรก จนกระทั่งค่าความชื้นลดลงถึงค่าวิกฤติ คือ มีค่าเท่ากับ ร้อยละ 18 หรือภายหลังทำการลด  
301 ความชื้นลง 12 ชั่วโมง กราฟความสัมพันธ์จะค่อนข้างลดลงอย่างคงที่และเป็นไปในอัตราที่ช้าลง นั้นเกิดจากผลของกลไกของ  
302 การดึงน้ำออกจากน้ำผึ้งในช่วงแรกที่ผิวหน้าของน้ำผึ้งยังมีความชื้นสูง หรือพื้นผิวยังชื้นมากอยู่ ทำให้น้ำที่ถูกดึงออกในช่วงแรก  
303 เป็นไปอย่างรวดเร็ว แต่เมื่อถึงจุดค่าความชื้นวิกฤติ (Critical moisture content) การดึงความชื้นออกจากตัวน้ำผึ้งจะเป็นไปได้  
304 ค่อนข้างยาก ทำให้อัตราการลดความชื้นเป็นไปอย่างช้า ๆ ในช่วงต่อมา แต่ทั้งนี้พบว่า เมื่อทำการลดความชื้นด้วยอุณหภูมิ 50  
305 และ 60 องศาเซลเซียส นั้น น้ำผึ้งจะมีความชื้นเหนียวและผิวหน้าค่อนข้างแห้ง ให้ลักษณะภายนอกเป็นสีน้ำตาลคล้ำ ซึ่งไม่  
306 สามารถนำไปพัฒนาเป็นครีมน้ำผึ้งต่อไป ทางผู้วิจัยจึงเห็นว่า การลดความชื้นด้วยอุณหภูมิ 40 องศาเซลเซียส ความดัน 5  
307 กิโลปาสคาล นาน 20 นาที เป็นสภาวะที่เหมาะสมสำหรับการลดความชื้นน้ำผึ้งดอกลำไยด้วยเครื่องอบแบบสุญญากาศ

308 ร่วมกับอินฟราเรด เนื่องจากสามารถลดความชื้นได้มากที่สุดและให้ค่าสีใกล้เคียงกับน้ำฝั่ก่อนการลดความชื้น (ไม่แตกต่างกัน  
 309 ทางสถิติ,  $p > 0.05$ ) และเมื่อสร้างความสัมพันธ์ระหว่าง GW ratio กับเวลา พบว่า เมื่อทำการลดความชื้นน้ำฝั่ดอกกล้วยด้วย  
 310 เครื่องอบระบบสุญญากาศร่วมกับอินฟราเรดที่แต่ละอุณหภูมิ ในเวลาที่นานขึ้น สัดส่วน GW จะเพิ่มขึ้นอย่างรวดเร็ว และมีค่า  
 311 มากกว่า 2.10 เมื่อทำการลดความชื้นที่อุณหภูมิ 40 องศาเซลเซียส ซึ่งจะให้น้ำฝั่เปลี่ยนแปลงสมบัติลักษณะเกิดการตกผลึกได้  
 312 (White, 1974) รวมถึงจัดเป็นสมบัติที่ดีสำหรับใช้เป็นผลิตภัณฑ์น้ำฝั่ตั้งต้นในการนำไปผลิตครีมน้ำฝั่ได้ในอนาคต ได้  
 313 (Suriwong *et al.*, 2020)

314 แต่ทั้งนี้ ลักษณะการลดความชื้นด้วยเครื่องอบแบบลมร้อน กลับให้ผลที่แตกต่างกับการลดความชื้นด้วยเครื่องอบแบบ  
 315 สุญญากาศร่วมกับอินฟราเรด โดยน้ำในน้ำฝั่จะค่อย ๆ ระบายออกในทุกสภาวะอุณหภูมิ จึงทำให้ใช้เวลานานกว่าการลด  
 316 ความชื้นด้วยเครื่องลดความชื้นแบบสุญญากาศร่วมกับอินฟราเรด คือ 6 ชั่วโมง ผลเกิดจากการที่ความชื้นไม่สามารถลดลงถึง  
 317 ค่าวิกฤติ สอดคล้องกับงานวิจัยของ Shu Khang Yap *et al.* (2019) ที่ทำการศึกษาผลของการลดความชื้นในน้ำฝั่ Kelulut ที่  
 318 อุณหภูมิ 55 และ 70 องศาเซลเซียส เป็นเวลา 18 ชั่วโมง พบว่า ค่าความชื้นยังสามารถลดลงได้อีก หรือเมื่อเพิ่มเวลานานถึง 84  
 319 ชั่วโมง ยังสามารถดึงน้ำออกจากน้ำฝั่ได้อีก ผู้วิจัยจึงได้ศึกษาแบบจำลองทางคณิตศาสตร์เพื่อทำนายลักษณะการลดความชื้น  
 320 ของน้ำฝั่ดอกกล้วยที่อุณหภูมิ 40 องศาเซลเซียส ทั้งแบบสุญญากาศร่วมกับอินฟราเรด และแบบอบลมร้อน ด้วยแบบจำลอง  
 321 ทางคณิตศาสตร์การอบแห้ง 3 แบบ คือ Newton's, Page's และ Modified Page's model ผลจากการพิจารณาค่า  $R^2$  ที่สูง  
 322 และค่า RMSE และ  $\chi^2$  ที่ต่ำที่สุด สอดคล้องกับงานวิจัยของ Kaewdam *et al.* (2013) จึงสามารถนำแบบจำลองของ  
 323 Newton's และ Page's มาประยุกต์ใช้เพื่ออธิบายปรากฏการณ์การลดความชื้นของน้ำฝั่ดอกกล้วย ซึ่งจะประโยชน์ต่อ  
 324 ผู้ประกอบการน้ำฝั่เพื่อนำไปพัฒนาต่อยอดในเตรียมวัตถุดิบน้ำฝั่ในการผลิตผลิตภัณฑ์ครีมน้ำฝั่ดอกกล้วยในอนาคตได้

325

### 326 สรุปผลการวิจัย

327 เมื่อทำการลดความชื้นน้ำฝั่ดอกกล้วยแบบสุญญากาศร่วมกับอินฟราเรดที่อุณหภูมิ 40 องศาเซลเซียส ความดัน 5  
 328 กิโลปาสคาล นาน 20 นาที ผลการศึกษาพบว่า เป็นสภาวะที่เหมาะสมสำหรับการลดความชื้นน้ำฝั่ดอกกล้วยโดยให้ค่าสี ( $L^*$ ,  
 329  $a^*$ ,  $b^*$ ) และค่าปริมาณน้ำอิสระ ( $a_w$ ) ไม่แตกต่างจากน้ำฝั่ก่อนนำมาลดความชื้นอย่างมีนัยสำคัญทางสถิติ ( $p > 0.05$ ) และจะ  
 330 สามารถปรับสัดส่วนน้ำตาลกลูโคสต่อน้ำ (GW ratio) ได้มากขึ้นจาก 1.70 เป็น 2.34 ซึ่งจะส่งผลให้น้ำฝั่ดอกกล้วยเกิดการตก  
 331 ผลึกได้เร็วขึ้นและมีสมบัติที่เหมาะสมต่อการนำไปผลิตครีมน้ำฝั่ต่อไปได้ ทั้งนี้การประยุกต์ใช้แบบจำลองทางคณิตศาสตร์ของ  
 332 Newton's และ Page's model ยังสามารถใช้อธิบายปรากฏการณ์การลดความชื้นน้ำฝั่ดอกกล้วย เมื่อต้องการลดความชื้นทั้ง  
 333 แบบสุญญากาศร่วมกับอินฟราเรด และแบบอบลมร้อน ที่อุณหภูมิ 40 องศาเซลเซียส ซึ่งจะประโยชน์ต่อผู้ประกอบการ  
 334 อุตสาหกรรมน้ำฝั่ต่อไปได้

335

### 336 กิตติกรรมประกาศ

337 ผู้วิจัยขอขอบคุณรัฐบาลกระทรวงวิทยาศาสตร์และเทคโนโลยี (ทุนพัฒนานวัตกรรมภาครัฐ) ประจำปี 2559 ภายได้  
 338 สังกัดคณะเทคโนโลยีการเกษตรและอาหาร มหาวิทยาลัยxx ที่สนับสนุนทุนวิจัยตลอดการศึกษา และ คณะวิศวกรรมและ  
 339 อุตสาหกรรมเกษตร มหาวิทยาลัยxx ที่เอื้อเฟื้อสถานที่ อุปกรณ์ และเครื่องมือวิเคราะห์สำหรับงานวิจัยนี้

340

## 341 เอกสารอ้างอิง

- 342 Assil, H. I., Sterling, R. & Sporns, P. (1991). Crystal control in processed liquid honey. *Journal of Food Science*,  
343 56(4), 1034-1034.
- 344 Basri, D., Fudholi, A. & Ruslan, M. H. (2012). Drying characteristics of the borneo Canarium odontophyllum (dabai)  
345 fruit. *American Journal of Agricultural and Biological Sciences*, 7, 347-356.
- 346 Bhandari, B., D'Arcy, B. & Kelly, C. (1999). Rheology and crystallization kinetics of honey: Present status.  
347 *International Journal of Food Properties*, 2(3), 217-226.
- 348 Bogdanov, S. (2009). *Harmonised methods of the International Honey Commission*. Bee Product Science,  
349 International Honey Commission. Retrieved Jan 9, 2018, from <http://www.bee-hexagon.net/en/network.htm>.
- 350 Conforti, P. A., Lupano, C. E., Malacalza, N. H., Arias, V. & Castells, C. B. (2006). Crystallization of Honey at  
351 20°C. *International Journal of Food Properties*, 9(1), 99-107.
- 352 Hempattarasuwan, P., Settachaimongkon, S. & Duangmal, K. (2019). Impact of botanical source and processing  
353 conditions on physicochemical properties and antioxidant activity of honey in the northern part of Thailand.  
354 *International Journal of Food Science & Technology*, 54(12), 3185-3195.
- 355 Ministry of Public Health. (2000). *Honey*. Notification of the Ministry of Public Health (No. 211) B.E. 2543 (2000).  
356 Retrieved Dec 5, 2017, from [http://food.fda.moph.go.th/law/data/announ\\_mophV.English/No.211-43%20Honey.pdf](http://food.fda.moph.go.th/law/data/announ_mophV.English/No.211-43%20Honey.pdf)  
357
- 358 Kaewdam, S., Nitatwicht, C., Varith, J. & Jaturonglumert, S. (2013). Mathematical model of freeze drying on  
359 mango. *Journal of Agricultural Research and Extension*, 30(3, Suppl.), 56-67.
- 360 Prissawong, S. (2005). Effect of Biochemical Composition on the Crystallization in Honey. Retrieved Nov 19, 2018,  
361 from [https://kb.psu.ac.th/psukb/bitstream/2553/2389/9/275795\\_ab.pdf](https://kb.psu.ac.th/psukb/bitstream/2553/2389/9/275795_ab.pdf)
- 362 Singh, I. & Singh, S. (2018). Honey moisture reduction and its quality. *Journal of Food Science and Technology*,  
363 55, 1-11.
- 364 Shu Khang Yap, Nyuk Ling Chin, Yus Aniza Yusof and Yeen Chong. (2019). Quality characteristics of dehydrated  
365 raw Kelulut honey. *International Journal of Food Properties*, 22(1), 556-571.
- 366 Suriwong, V., Jaturonglumert, S., Varith, J., Narkprasom, K. & Nitatwicht, C. (2020). Crystallisation behaviour of  
367 sunflower and longan honey with glucose addition by absorbance measurement. *International Food*  
368 *Research Journal*, 27(4), 727-734.
- 369 White Jr., J.W. (1974). Beekeeping: honey and honey products. In Johnson, A.H.; Peterson, M.S. (Eds.),  
370 *Encyclomedia of food technology*. (pp. 103-108). The Avi Publishing Company: Westport, Connecticut.
- 371 White Jr., J. W. (1975). Physical characteristics of honey. In E. Crane (Ed), *Honey: A Comprehensive Survey*.  
372 (pp. 207-239). Heinemann, London.
- 373

## CURRICULUM VITAE

**NAME** Mrs. Voraluck Suriwong

**DATE OF BIRTH** 9 January 1981

**EDUCATION** 2017-Present : D.Eng course at Food Engineering Program,  
Faculty of Engineering and Agro-industry, Maejo University.  
2003-2005 : M.Eng (Food Engineering), Department of  
Food Engineering, Faculty of Engineering, King Mongkut's  
University of Technology Thonburi.  
1999-2003 : BSc. (Food Science and Technology), 2nd  
Class Honor, Department of Food Science and  
Technology, Faculty of Agro-Industry, Chiang Mai  
University.  
1998 : M.6 Certificate, Dara Academy, Chiang Mai.

**WORK EXPERIENCE** 2012-Present : Lecturer in Agricultural and Food  
Engineering program, Faculty of Food and Agricultural  
Technology, Pibulsongkram Rajabhat University,  
Phitsanulok.  
2009-2012 : Working in Princess Foods Co.,Ltd., Mae-Tang,  
Chiang Mai, position in Senior Supervisor of production  
planning department.  
2005-2009 : Working in Saha Farms Co.,Ltd., Saha  
Interfoods plant at Lopburi, position in Quality Assurance  
Manager of Quality Assurance department.